

FIJACIONES, GRAPAS Y TORNILLERIA



TOYOTA

RENAULT

MITSUBISHI



Mercedes-Benz

PEUGEOT

DODGE



Audi

HYUNDAI

CITROËN



CHEVROLET



SEAT

HONDA



Jeep



mazda

DACIA

Grapas Tapizados	261	
	161.415	2,7 mm.
	162.600	3 mm.
	161.468	4 mm.

Grapas NP-NR-SNP	261	
	161.469	2,5 mm.
	161.412	3 mm.
	161.413	3,5 mm.
	161.414	4 mm.

Tuercas C-4800	261	
	162.625	Ø M-4
	162.626	Ø M-5
	162.627	Ø M-6
	162.629	Ø M-8

Tuercas DIN 6923	261	
	162.588	Ø M-5
	162.589	Ø M-6
	162.590	Ø M-8

Tuercas C-4830	261	
	162.413	Ø M-4
	162.925	Ø M-5
	162.414	Ø M-6
	162.415	Ø M-8

... con arandela móvil	261	
	162.711	Ø M-6
	162.712	Ø M-8

Tuercas enjauladas	261	
	161.467	Ø M-6



161.483

Ø cabeza : 15 mm.
Ø agujero : 7 mm.

U.E.	DESCRIPCION	261	Ref. Adaptable
50	Fijac. metálica universal pasoruedas y varios	161.483	

Ø 3,9 x 25



161.454

Ø 4,2 x 13



161.431

Ø 4,2 x 17
arandela Ø 14



162.702

Ø 4,2 x 18



161.851

Ø 4,2 x 18
arandela Ø 15



161.860

Ø 4,2 x 20
arandela Ø 17



161.852

Ø 4,7 x 15
arandela Ø 18



161.861

Ø 4,7 x 16



161.862

Ø 4,8 x 15



161.477

Ø 4,8 x 15
arandela Ø 15



161.832

Ø 4,8 x 16
arandela Ø 15



161.473

Ø 4,8 x 18
arandela Ø 15



161.474

Ø 4,8 x 20



161.453

Ø 4,8 x 22



162.710

Ø 5 x 14,5
arandela Ø 16



161.848

Ø 5 x 17
arandela Ø 16



161.835

Ø 5 x 25



161.831

Ø 5,2 x 19
arandela Ø 12



161.846

Ø 5,5 x 19
arandela Ø 22



161.742

Ø 5,5 x 19
arandela Ø 18



162.555

Ø 6,2 x 17
arandela Ø 16



161.850

Ø 6,2 x 22
arandela Ø 18



161.847

Ø 6,3 x 14



161.739

Ø 6,3 x 15



161.432

Ø 6,3 x 16



162.478

Ø 6,3 x 16
arandela Ø 16



161.829

Ø 6,3 x 18
arandela Ø 18



161.799

Ø 6,3 x 19
arandela Ø 18



162.556

Ø 6,3 x 19
arandela Ø 22



161.743

Ø 6,3 x 20
arandela Ø 20



161.827

Ø 6,3 x 24
arandela Ø 16



161.820



Ø M5 x 11



161.758



161.458

Ø M6 x 11
arandela Ø 14



161.753

Ø M6 x 12
arandela Ø 18



161.798

Ø M6 x 13



161.733

Ø M6 x 17,5



161.732

Ø M6 x 18



161.734

Ø M6 x 18



161.752

Ø M6 x 18
arandela Ø 18



161.730

Ø M6 x 19



161.486

Ø M6 x 20



161.456

Ø M6 x 20



161.457

Ø M6 x 20



161.706

Ø M6 x 20
arandela Ø 18



161.727

Ø M6 x 20
arandela Ø 22



161.724

Ø M6 x 21



161.430

Ø M6 x 22



162.528

Ø M6 x 22
(cabeza 20 x 20)



162.356

Ø M6 x 25
arandela Ø 18



161.723

Ø M6 x 25
(En jaula móvil)



161.450

Ø M6 x 27



162.397

Ø M6 x 28
arandela Ø 24



161.731

Ø M7 x 15



161.728

Ø M8 x 16



162.363

Ø M8 x 18
(cabeza 20 x 20)



162.357

Ø M8 x 20



161.705

Ø M8 x 20



161.455

Ø M8 x 22



162.619

Ø M8 x 26,5



161.729







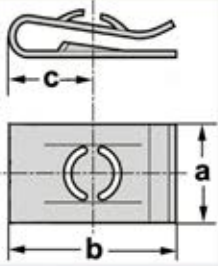





Ø M8 x 30















161.440



\varnothing = diámetro tornillo
 a x b = medidas exteriores
 c = distancia eje fijación

	261	\varnothing	a x b (c)
	161.487	2,9	8 x 10 (4,8)
	161.447	2,9	9 x 16,5 (10)
	161.757	2,9	10,8 x 13 (7)
	162.591	3,5	9 x 12 (7,5)
	161.409	3,5	11 x 16 (8,5)
	161.426	3,5	12 x 15 (9)
	161.490	3,9	11,2 x 16 (8)
	161.741	4,2	11 x 13 (6,5)
	161.418	4,2	11 x 13 (7)
	161.493	4,2	11 x 15,5 (7,5)
	161.736	4,2	11 x 16,2 (8)
	161.484	4,2	11 x 16,2 (9)







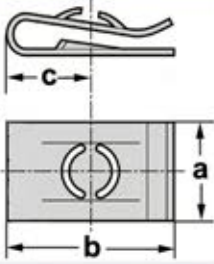





	261	\varnothing	a x b (c)
	162.635	4,2	11 x 16,5 (8)
	161.492	4,2	11 x 16,5 (8,5)
	161.853	4,2	11 x 17 (8,5)
	161.410	4,2	11 x 18 (9)
	161.488	4,2	11,6 x 15 (8)
	161.744	4,2	12 x 16,2 (8,5)
	161.427	4,2	15 x 20 (8,5)
	161.495	4,8	11 x 16,5 (8,5)
	161.788	4,8	11,1 x 16,5 (8)
	161.738	4,8	11,2 x 16,5 (9)
	161.839	4,8	11,2 x 16,7 (8,5)
	161.411	4,8	12 x 15 (8)
	161.737	4,8	12,5 x 16,5 (9,5)













	261	Ø	a x b (c)
	161.787	4,8	13,1 x 18,5 (10)
	161.498	4,8	15 x 16 (9)
	161.800	4,8	11 x 16,1 (8)
	161.859	4,8	16,1 x 21 (13)
	161.491	4,8	16,2 x 19 (11)
	161.702	4,8	16,3 x 19,3 (12)
	161.801	4,8	14,5 x 18 (11)
	161.749	4,8	18,5 x 21,5 (12)
	161.806	4,8	15 x 20,5 (11)
	161.840	4,8	16 x 19 (12)
	161.748	4,8	22 x 25,5 (15)

	261	Ø	a x b (c)
	161.746	5,5	14,5 x 25,8 (17,5)
	161.771	5,5	14,6 x 24,2 (20)
	161.745	5,5	15,8 x 23,6 (13)
	161.704	5,6	13,2 x 21 (12)
	161.437	6,3	14 x 30 (18,5)
	161.449	6,3	15 x 23 (14)
	161.436	6,3	16 x 31,2 (22,5)
	162.479	6,3	16 x 20,2 (11)
	161.747	6,3	16,2 x 24,8 (14)
	161.756	6,3	16,5 x 26,5 (14)
	161.465	6,3	17,2 x 23 (14)
	162.634	6,3	18,2 x 16,5 (9)



\varnothing = diámetro tornillo
 a x b = medidas exteriores
 c = distancia eje fijación

	261	\varnothing	a x b (c)
	161.487	2,9	8 x 10 (4,8)
	161.447	2,9	9 x 16,5 (10)
	161.757	2,9	10,8 x 13 (7)
	162.591	3,5	9 x 12 (7,5)
	161.409	3,5	11 x 16 (8,5)
	161.426	3,5	12 x 15 (9)
	161.490	3,9	11,2 x 16 (8)
	161.741	4,2	11 x 13 (6,5)
	161.418	4,2	11 x 13 (7)
	161.493	4,2	11 x 15,5 (7,5)
	161.736	4,2	11 x 16,2 (8)
	161.484	4,2	11 x 16,2 (9)

	261	\varnothing	a x b (c)
	162.635	4,2	11 x 16,5 (8)
	161.492	4,2	11 x 16,5 (8,5)
	161.853	4,2	11 x 17 (8,5)
	161.410	4,2	11 x 18 (9)
	161.488	4,2	11,6 x 15 (8)
	161.744	4,2	12 x 16,2 (8,5)
	161.427	4,2	15 x 20 (8,5)
	161.495	4,8	11 x 16,5 (8,5)
	161.788	4,8	11,1 x 16,5 (8)
	161.738	4,8	11,2 x 16,5 (9)
	161.839	4,8	11,2 x 16,7 (8,5)
	161.411	4,8	12 x 15 (8)
	161.737	4,8	12,5 x 16,5 (9,5)



Remache Ø 2,4 x 5 especial Fiat, Opel, PSA, VAG

162.362



Remache Ø 3,2 x 9, con cabeza Ø 6,5, especial VAG

161.865



Remache estanco Ø 3,2 x 13, con cabeza Ø 6, especial VAG

161.866



Remache Ø 3,8 x 6,2, con cabeza Ø 6, especial Toyota, Lexus

161.845



Remache Ø 4 x 8, con cabeza Ø 8 especial Toyota

161.849



Remache estanco Ø 4 x 11, especial Ford

162.384



Remache Ø 4 x 13, con cabeza Ø 10,4 especial Toyota

161.871



Remache Ø 4 x 20, con cabeza Ø 11,8 especial Volvo

161.870



Remache Ø 4,8 x 10 con cabeza Ø 16, especial Fiat

161.864



Remache Ø 4,8 x 11, con cabeza Ø 9,5 especial Hyunda/Kia

161.868



Remache Ø 4,8 x 13 con cabeza Ø 13,8, especial Fiat

161.863



Remache Ø 4,8 x 12 con cabeza Ø 10, especial Renault

162.939



Remache Ø 4,8 x 15 con cabeza Ø 9,5, especial VAG

161.867



Remache Ø 4,8 x 15,5, con cabeza Ø 9,5, especial Ford

161.869



Remache Ø 4,8 x 17 con cabeza Ø 16, especial Fiat

161.814



Remache Ø 4,8 x 21 con cabeza Ø 9,5, especial Fiat, Ford

161.796



Remache Ø 4,8 x 23,5 con cabeza Ø 12, especial Renault

161.802



Remache Ø 5,8 x 20 con cabeza Ø 16, especial Ford

161.795



Remache Ø 5 x 11, con arandela Ø 20 especial Renault

162.709



Remache Ø 6,4 x 10, con cabeza Ø 10,8, especial VAG

161.844



Remache Ø 7,5 x 28 especial PSA

161.481

**301.290**

Abrazadera 4,8 x 115 con soporte

**301.296**

Abrazadera 5 x 145 con soporte

**301.295**

Abrazadera 5,1 x 140 con soporte

**301.293**

Abrazadera 5,1 x 140 con soporte

**301.291**

Abrazadera 6,1 x 150 con soporte

**301.292**

Abrazadera 7,1 x 145 con soporte

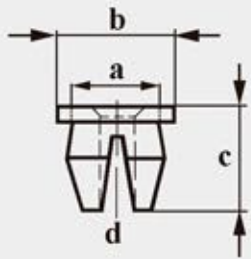

$\varnothing a$ = diámetro taladro
 $\varnothing b$ = diámetro cabeza
 c = altura fijación
 $\varnothing d$ = diámetro agujero para tornillo

	261	$\varnothing a$	$\varnothing b$	c	$\varnothing d$
	162.242	8	11	17	3,5
	162.243	10	14	19	4,8
	162.457	11	15	19	5

	261	$\varnothing a$	$\varnothing b$	c	$\varnothing d$
	163.063	6x15	11x21	17	3,5
	162.851	6,7x12,9	9,6x16,1	11,9	2,9
	163.767	7x11,7	9x14,5	12	4,2

	261	$\varnothing a$	$\varnothing b$	c	$\varnothing d$
	162.902	7x12	9x15	10	4,2
	162.523	7x13	10x16	10	4,2
	163.502	7x14	9x15	10	3,9
	163.350	7x14	9x15	10	4,2
	163.881	7x14	9,5x15	10	2,9
	162.892	7x14	11x18	12	3,9
	163.222	7x14	13x20	17,2	3,9
	162.483	7x14	13x20	17	4,2
	162.888	7x15	10x18	10	4,2
	163.882	7x15	14x20	17	3,9
	164.062	7,5x10,5	12,2x17	16	2,9
	163.298	7,5x11,4	9,5x16,6	11	2,9
	164.583	8x11,6	12x15,8	11,4	5,5
	164.101	8x11,6	15x19	17,2	5,5

	261	Ø a	Ø b	c	Ø d
	164.635	8x11,8	12x16	11,3	5,5
	164.629	10x19,3	13x21,6	11,6	4,2
	162.326	6	9,5	7,5	2,5
	162.842	6x6,5	10	7	2,5
	162.963	6,7	9	9,5	3,9
	162.245	6x7	15	9	3,5
	164.134	6,7x7,4	9,3	12,5	4,2
	164.704	6,8x7,5	12	12	4,2
	162.240	7	9	10	3,5
	163.181	7	9	12	3,5
	162.715	7	9	12	4,2
	162.238	7	9,5	9	3
	162.237	7	9,5	9	3,5
	164.129	7	9,5	11,8	4,5
	164.644	7	9,5	12,2	4,8

	261	Ø a	Ø b	c	Ø d
	164.065	7	9,5	14,9	4,8
	163.172	7	10	8,5	4,2
	162.609	7	10	10	3
	162.817	7	10	13	3,5
	162.717	7	10	16	3,5
	162.401	7	11	13	3
	162.776	7	11	14	3,5
	162.331	7	11	14	4
	162.775	7	12	17	4
	164.438	7	12	17	5
	162.244	7	13	9	4,2
	163.281	7	13	16	3,9

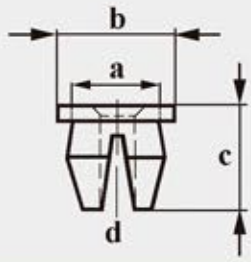

$\varnothing a$ = diámetro taladro
 $\varnothing b$ = diámetro cabeza
 c = altura fijación
 $\varnothing d$ = diámetro agujero para tornillo

	261	$\varnothing a$	$\varnothing b$	c	$\varnothing d$
	163.611	7	14	21	4,2
	163.426	7,2	9	9	3,5
	164.142	7x7,3	12	15	4,8
	162.774	7x7,5	7x12	12	3,5
	164.168	7,5x8,3	10	11,4	4,8
	164.730	7,6x7,6	15,6	18	4,8
	164.543	7,6x8,2	10	10	3,6
	164.061	7,7	12,7	10	4,2
	162.534	8	11	13	4,5
	163.275	8	12	9	5,5

	261	$\varnothing a$	$\varnothing b$	c	$\varnothing d$
	163.427	8	13	12	4,2
	163.211	8	14	10	5,5
	163.883	8	14	16,5	
	162.903	8	15,5	17	4
	164.124	8	15,7	20	4
	164.579	8	16	15,2	4,8
	163.894	8	16	17,5	5,5
	164.626	8	16	18,3	5
	163.051	8	16	19	4,8
	164.079	8x8,5	11	9	4,2
	163.520	8x8,5	16	20	4,8

	261	Ø a	Ø b	c	Ø d
	162.955	8x10	20	12,5	5,5
	163.439	8,2	11	12	4,2
	162.985	8,2	12	11,9	4,2
	164.352	8,1x8,5	16,9	13,3	6
	162.649	8,5	11,5	11	4
	164.616	8,5	14x14	15	5,5
	163.484	8,5	15	10	5,5
	163.519	8,5	17	10	5,5
	164.841	8,5	18	18,1	4,8
	163.689	8,5	18	19,5	4,2
	163.268	8,5	18	19,5	5,5

	261	Ø a	Ø b	c	Ø d
	164.581	8,5	20	22	5,5
	163.192	8,5x10,5	13,4x15,3	10,2	5,5
	164.677	8,6x8,9	12,1x12,1	12,3	4,2
	164.290	9x11	14,2x16,2	11,8	5,5
	163.256	9	17	11	5,5
	164.738	9	18,5	17,8	5,5
	163.165	9	20	18	5,5
	164.091	9	20	24	5,5
	163.622	9	20,5	11,5	5,5
	163.367	9,5	13	21	6,35

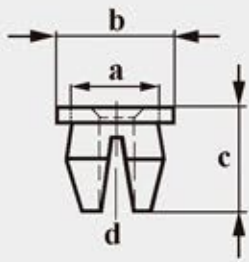

- Ø a = diámetro taladro
- Ø b = diámetro cabeza
- c = altura fijación
- Ø d = diámetro agujero para tornillo

	261	Ø a	Ø b	c	Ø d
	163.505	9,5	13,5	19,5	4,8
	164.801	9,5	14	20,3	5,5
	164.577	9,5	20	20	5,5
	162.480	9,5	22	21	4,8
	164.576	9,5x9,8	21,8	9,5	4,8
	163.180	9,5x14	20	14	4,8
	164.634	9,8x10,5	16	11	5,5
	163.538	10	12	11,5	4,8
	162.241	10	13	13	3,5

	261	Ø a	Ø b	c	Ø d
	162.928	10	13	20	4,8
	162.718	10	13	20	5,5
	162.545	10	14	15	4
	163.274	10	16	10	5,5
	164.078	10,7	15,3	14	4,5
	162.811	10x13	13x14	19	5,5
	163.377	10,8x11,2	16	12	6,35

TAPONES UNIVERSALES



162.661



162.662



162.663

U.E.	261	Medidas
------	-----	---------

25	162.661	Cabeza 16,7 mm. Agujero mín/máx. 9,5/13,5 mm.
----	---------	--

25	162.662	Cabeza 24,8 mm. Agujero mín/máx. 14/21 mm.
----	---------	---

25	162.663	Cabeza 34,8 mm. Agujero mín/máx. 22/30 mm.
----	---------	---

Omegas	261	Ø interior	U.E.
--------	-----	------------	------



162.332	Ø 8	25
---------	-----	----



162.570	Ø 11	25
---------	------	----



162.344	Ø 13	25
---------	------	----



162.575	Ø 16	25
---------	------	----



162.940	Ø 24	25
---------	------	----



188.007

Tirante goma capó con soporte de plancha
PEQUEÑO





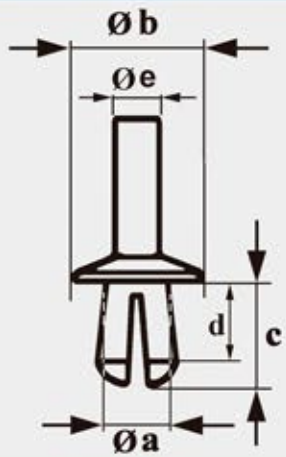



188.054









Tirante goma capó con soporte de plancha
GRANDE



	261	$\varnothing a$	$\varnothing b$	c (d)	$\varnothing e$
	162.431	3,5	8	7 (6)	2,1
	163.717	4	7,8	8,5 (7)	2
	162.664	4,5	7	7 (5,1)	4,2
	164.628	4,7	10,6	12 (8,5)	3
	164.118	4,7	15,2	11,5 (9)	3
	164.287	5	8,5X12	9 (6)	2,9
	163.926	5	9	7 (5,5)	3
	164603	5	9,6	9,5 (7,5)	3

	261	$\varnothing a$	$\varnothing b$	c (d)	$\varnothing e$
	163.910	5	10	7,5 (5,5)	3
	164.792	5	10	10 (7,5)	3,2
	164.257	5	10	10,5 (9)	3
	164.110	5	10	11 (9)	3
	163.329	5	10	11 (9)	3,2
	164.396	5	10	12 (9)	2,8
	162.259	5	10	15,8 (12)	2,9
	164.735	5	11,5	7,5 (6)	3
	163.792	5	12	11 (8,2)	3
	164.275	5	15,2	11,5 (9,5)	3





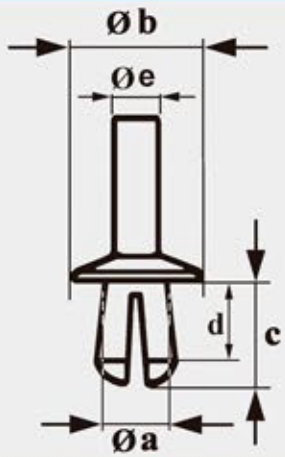

	261	Ø a	Ø b	c (d)	Ø e
	162.456	5,5	9,4	10,8 (8,2)	3,2
	163.793	5,5	12	11 (9,5)	3
	163.299	5,5	16	10 (8)	3,5
	163.303	5,5	16	10 (8)	3,5
	163.305	5,5	16	11 (7,5)	3
	163.056	5,5	10x12	10 (6,4)	4x5
	164.415	5,7	11	20 (2)	3,5
	164.056	5,7	16	10 (8)	3,4
	164.286	5,8	20	14 (9)	3,8







	261	Ø a	Ø b	c (d)	Ø e
	162.819	6	10	11,5 (9,1)	3,2
	162.821	6	10	12 (9)	4
	164.274	6	10	12 (9,5)	3,5
	162.519	6	10	18 (9)	4,7
	163.961	6	11	10 (8,3)	3,9
	164.228	6	11,8x18	10 (7,5)	4
	163.485	6	12	9 (8)	3,5
	164.736	6	12	13 (7)	3,5
	163.140	6	12	13 (8)	3,9





$\varnothing a$ = diámetro agujero
 $\varnothing b$ = diámetro cabeza
 c = altura total fijación
 d = altura fijación
 $\varnothing e$ = diámetro espiga

	261	$\varnothing a$	$\varnothing b$	c (d)	$\varnothing e$
	163.487	6	12	14 (13)	3,5
	162.624	6	13	9,2 (7,8)	3,9
	164.084	6	14	17 (11)	4
	164.784	6	14	17,5 (10,5)	4
	164.592	6	15	8 (6)	3,4
	163.271	6	15	11 (9)	4
	163.295	6	15	12,5 (7,5)	3,8

	261	$\varnothing a$	$\varnothing b$	c (d)	$\varnothing e$
	163.270	6	15	13,5 (9)	4
	163.044	6	15	15 (12)	3,6
	163.047	6	15	20 (17)	3,5
	164.253	6	15	20 (17)	3,4
	163.810	6	15	22,5 (13)	3,9
	163.054	6	16	10 (7)	3,9
	163.198	6	16	14 (12)	3,4

	261	Ø a	Ø b	c (d)	Ø e
	163.235	6	16	10 (15)	3,9
	164.353	6	18	13 (7,5)	3,5
	164.236	6	18	16 (11,5)	3,5
	163.068	6	20	14 (10)	3,5
	163.046	6	20	14 (12)	3,6
	163.045	6	20	15 (12)	3,6
	164.739	6	20	16,5 (13)	3,4



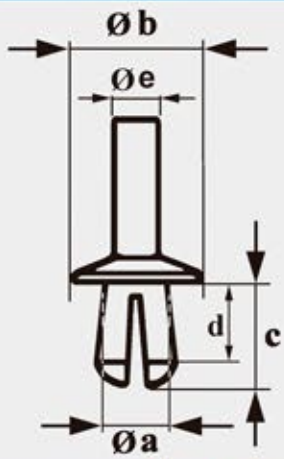





	261	Ø a	Ø b	c (d)	Ø e
	164.255	6	20	17 (13)	3,8
	163.048	6	20,5	20 (17)	3,4
	163.291	6x6	7x15	13 (7,4)	4
	162.852	6x6	8x15	12 (8,6)	4
	163.210	6x8	16	(9)	4
	163.486 (U.E.=50)	6,2	10	9 (8)	3,6
	162.389	6,2	11	10 (8)	4
	162.481	6,2	12	9 (7)	3,3



$\varnothing a$ = diámetro agujero
 $\varnothing b$ = diámetro cabeza
 c = altura total fijación
 d = altura fijación
 $\varnothing e$ = diámetro espiga

	261	$\varnothing a$	$\varnothing b$	c (d)	$\varnothing e$
	162.424	6,2	12,2	11 (7,4)	4
	163.168	6,2	14	11,5 (9)	4
	162.957	6,2	16	17 (10)	4
	163.328	6,2	17	9	4
	164.126	6,2	17	15 (12,2)	3,9
	163.442	6,2	17	17 (11)	3,5
	163.169	6,2	18	11 (7)	4

	261	$\varnothing a$	$\varnothing b$	c (d)	$\varnothing e$
	162.906	6,2	20	10 (7,4)	4
	163.206	6,5	10x22	7,2 (3,5)	4
	162.666	6,5	10x22	9 (3,7)	4
	164.022	6,5	15x22	16,5 (14)	3,5
	163.392	6,5	15	8 (8)	3,5
	162.258	6,5	15	11 (9)	4
	163.475	6,5	15	13 (8)	4,3
	163.300	6,5	15	13	5
	163.859	6,5	15	17	4,5

	261	Ø a	Ø b	c (d)	Ø e
	164.406	6,5	15,3	19 (11,5)	3,5x5
	164.785	6,5	15,3	22,5 (13)	4
	163.640	6,5	16	11 (8)	3,8
	163.389	6,5	16	11 (9)	4
	163.301	6,5	16	13	4,5
	164.706	6,5	16	14,5	4,6
	163.735	6,5	17,5	9,5 (6)	4
	164.313	6,5	17,5	22,5 (13)	3,8

	261	Ø a	Ø b	c (d)	Ø e
	164.256	6,5	18	20 (9,5)	3x5,9
	163.070	6,5	19	8,6 (5,6)	3,3
	164.650	6,5	19,6	15 (11)	3,4
	163.757	6,5	20	11,2 (8,5)	3,9
	164.815	6,5	20	12 (8)	4,6
	163.610	6,5	20	20 (18)	3,4
	162.979	6,5	22	14 (10)	3,5

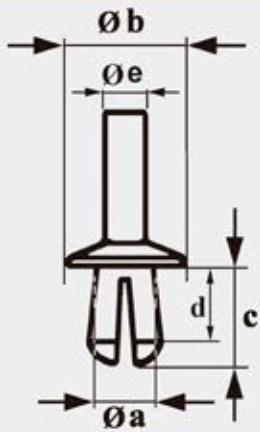

$\varnothing a$ = diámetro agujero
 $\varnothing b$ = diámetro cabeza
 c = altura total fijación
 d = altura fijación
 $\varnothing e$ = diámetro espiga

	261	$\varnothing a$	$\varnothing b$	c (d)	$\varnothing e$
	164.737	6,7	11	14 (7,5)	4
	164.189	6,8	16	8 (5,8)	3,5
	163.249	6,8	17	6 (5,3)	4,4
	164.187	6,8	18,5	12 (9,5)	5
	164.099	6,8	19	10 (8,5)	4,6
	164.678	6,8	20	9 (6,8)	3,7
	164.817	6,8	20	10,5 (9)	4,5
	164.527	7	12	12,8 (9,2)	4

	261	$\varnothing a$	$\varnothing b$	c (d)	$\varnothing e$
	164.060	7	13,9	15 (12,5)	4,5
	164.827	7	15,2	16,5 (14)	3,8
	164.787	7	16	14 (6)	4
	164.087	7	17	8,5 (6,5)	4
	163.269	7	17	10 (8)	5
	163.530	7	18	8 (8)	5
	162.505	7	18	17 (13)	4
	164.261	7	18	17 (13)	4

	261	Ø a	Ø b	c (d)	Ø e
	164.043	7	18	17,5 (7)	3x6
	163.128	7	19,5	16 (7)	4
	163.302	7	20	8 (6)	10
	163.476	7	20	10 (9)	5
	163.529	7	20	11 (9)	5
	164.024	7	20	11 (9)	5
	163.167	7	20	11	6
	163.827	7	20	11,5 (8,5)	4
	164.589	7	20	11,5 (10)	3,8

	261	Ø a	Ø b	c (d)	Ø e
	163.125	7	11x18	13 (5)	3x3
	162.812	7x7	11	10 (5)	4
	163.036	7x7	13,5	13,5 (9)	4x4
	164.100	7	18,6	22 (15)	3,9
	163.020	7x8	10x12	7,7 (5)	3,6
	163.369	7,2	20	14 (12)	4,7
	164.807	7,3	20	15,5 (7)	5

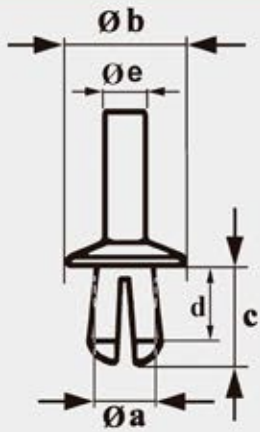



$\varnothing a$ = diámetro agujero
 $\varnothing b$ = diámetro cabeza
 c = altura total fijación
 d = altura fijación
 $\varnothing e$ = diámetro espiga

	261	$\varnothing a$	$\varnothing b$	c (d)	$\varnothing e$
	164.193	7,5	12,6	12,3 (10,5)	5,4
	164.153	7,5	16	13 (9)	6,4
	164.299	7,5	16,8	15,5 (10,5)	4,8
	163.794	7,5	17	14,5 (8)	4
	163.813	7,5	18	18,5 (13,5)	5,5
	164.155	7,5	19,7	10 (8)	6

	261	$\varnothing a$	$\varnothing b$	c (d)	$\varnothing e$
	164.711	7,5	20	10,2 (7,5)	5
	164.760	7,5	20	11 (8)	6,2
	164.537	7,5	20	13 (10)	3,4x5,7
	163.743	7,5	21,7	13 (10,5)	5,5
	164.258	7,5	25	25 (11)	4,5x6
	164.156	7,6	19,8	18 (9)	5,8
	164.842	7,8	18	14 (10)	5,3
	164.808	7,8	20	10 (5)	5,5
	164.055	7,8	20	12 (7,5)	5,5

	261	Ø a	Ø b	c (d)	Ø e
	164.617	7,8	20	13 (9,5)	5,7
	164.798	7,8	20	14 (9,5)	5
	162.632	8	12	11 (7)	5
	162.665	8	12x17	9,6 (6)	5
	164.192	8	12,6	12,5 (10,8)	5,4
	164.063	8	12,8	12,2 (10,5)	5,4
	164.604	8	12,8	12,2 (10,5)	5,4
	163.927	8	13	15 (12)	4



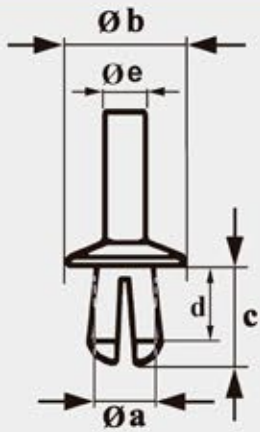



	261	Ø a	Ø b	c (d)	Ø e
	162.843	8	14	11 (7)	4
	163.170	8x8	14	12 (8)	4x4
	164.097	8	14,8	10,8 (9)	3,9
	163.922	8	15,3	13 (8)	5,5
	163.923	8	15,3	13 (8)	5,5
	163.307	8	16	11 (6)	5
	162.373	8	16	12 (8)	4,9



$\varnothing a$ = diámetro agujero
 $\varnothing b$ = diámetro cabeza
 c = altura total fijación
 d = altura fijación
 $\varnothing e$ = diámetro espiga

	261	$\varnothing a$	$\varnothing b$	c (d)	$\varnothing e$
	163.304	8	16	14 (10)	4,7
	162.765	8x8	16	14 (10)	5,5
	163.503	8	18	12 (10)	6
	163.166	8	18	14 (7,6)	6x7
	162.517	8	18	18 (14)	4,8



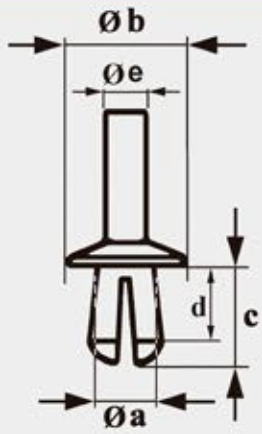

	261	$\varnothing a$	$\varnothing b$	c (d)	$\varnothing e$
	163.889	8	19	15,2 (12)	5
	163.918	8	19	17 (9,5)	7x4
	164.161	8	19,5	10 (6)	5,5
	164.809	8	19,8	12 (7)	6
	164.664	8x8	19,8	15	4,6
	163.014	8	20	8,5 (5,4)	4
	163.074	8	20	9 (6)	5
	163.035	8	20	9 (6)	6

	261	Ø a	Ø b	c (d)	Ø e
	164.314	8	20	9 (7)	6
	163.171	8	20	10 (6,4)	5,3
	164.230	8	20	12 (9)	5,6
	163.277	8	20	12,5 (7)	5x5
	163.344	8	20	13 (8)	3x6
	163.482	8	20	13 (8)	6x7
	163.085	8	20	13,5 (8)	3,9
	163.069	8	20	13,5 (11)	4,9









	261	Ø a	Ø b	c (d)	Ø e
	163.409	8	20	14 (13)	5
	163.815	8	20	15 (11)	5x5
	163.384	8	20	15 (7)	6
	163.448	8	20	16 (11)	7
	163.278	8	20	20 (11)	5,8
	163.091	8	20	21 (12)	5x7
	164.371	8	20	21 (13)	3,8x7,3



$\varnothing a$ = diámetro agujero
 $\varnothing b$ = diámetro cabeza
 c = altura total fijación
 d = altura fijación
 $\varnothing e$ = diámetro espiga

	261	$\varnothing a$	$\varnothing b$	c (d)	$\varnothing e$
	164.601	8	20	21,5 (10)	7x4,7
	164.663	8	20	24 (13)	7x4,7
	163.306	8	22	13 (10)	4,4
	162.260	8	24	16 (11)	5
	163.734	8	25	24,5 (14)	6,2x4

	261	$\varnothing a$	$\varnothing b$	c (d)	$\varnothing e$
	163.780	8	30	16 (8,5)	5
	164.122	8x9	9,7x12,7	8,5 (5)	7x5
	162.958	8x10	12	15 (4,5)	5
	162.766	8x10	24	13 (10)	5
	163.088	8,2	18	14 (10)	4
	164.254	8,2	18	18 (12)	4,3x5,7
	164.405	8,2	18,3	23,5 (17,5)	6

	261	Ø a	Ø b	c (d)	Ø e
	164.600	8,3	20	20 (7,5)	4,5x7,3
	163.925	8,5	12	10 (7)	4,9
	163.981	8,5	15	27 (13)	5,2
	162.341	8,5	16	13 (8)	4
	163.474	8,5	18	11 (8)	6
	163.390	8,5	18	12 (8)	5,8
	163.391	8,5	18	12 (8)	5,8
	164.085	8,5	18	16 (10,5)	7

	261	Ø a	Ø b	c (d)	Ø e
	163.963	8,5	18	19 (14,8)	4,8
	163.127	8,5	20	11 (4,4)	4x4
	164.107	8,5	20	14 (12)	4,9
	164.607	8,5	20	20 (8)	4,8x7
	164.640	8,5	20	28 (20)	7
	163.924	8,5	25	13,5 (10,5)	6
	163.296	9	15	26 (16)	5,3

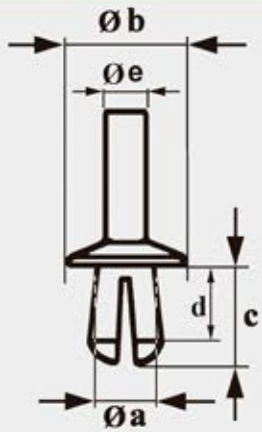

$\varnothing a$ = diámetro agujero
 $\varnothing b$ = diámetro cabeza
 c = altura total fijación
 d = altura fijación
 $\varnothing e$ = diámetro espiga

	261	$\varnothing a$	$\varnothing b$	c (d)	$\varnothing e$
	163.756	9	16	12	6,7
	164.416	9	17,8	19 (14,5)	4,9
	163.358	9	18	27 (19)	7x8
	163.297	9	20	27 (17)	5,5

	261	$\varnothing a$	$\varnothing b$	c (d)	$\varnothing e$
	164.312	9	22	15 (13)	7
	164.179	9,5	19,8	26,5 (16)	7,8
	164.086	9,5	20,2x30	20 (15)	7,8
	164.073	9,5	22	7,5 (4)	7,2
	164.157	9,7	19,4	15,5 (13,5)	8,10
	164.154	9,7	19,7	11,5 (9,5)	8
	164.177	9,8	20	16,5 (11)	6,5
	164.178	9,8	20	20,5 (13)	6,5

	261	Ø a	Ø b	c (d)	Ø e
	164.707	9,8	20	21 (17,5)	7,5
	163.276	10	18	18 (13)	8x10
	163.037	10	20	14 (11)	7
	163.164	10	20	15 (11)	8x9
	164.292	10	20	16 (8)	6
	163.802	10	20	20 (15,5)	8x8
	163.163	10	20	25 (15)	7

	261	Ø a	Ø b	c (d)	Ø e
	164.315	10	20x30	13,5 (8,5)	7,8
	164.051	11	16	13 (8)	6,5
	162.425	11	25	14 (8)	7
	163.903	12	18	10 (6)	8
	163.973	14	25	21 (13)	8
	163.814	15	22	16 (12)	12
	164.675	22	29	11 (8)	19
	164.555	22	37,8	32 (29)	12,3

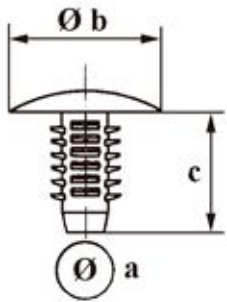

$\varnothing a$ = diámetro taladro
 $\varnothing b$ = diámetro cabeza
 c = altura fijación

261/

$\varnothing a = 4,7$
 $\varnothing b = 18$
 $c = 25$



164.857 negro

$\varnothing a = 5,2$
 $\varnothing b = 16$
 $c = 26$



163.317 negro

$\varnothing a = 5$
 $\varnothing b = 11$
 $c = 12$



163.086 negro

$\varnothing a = 5,5$
 $\varnothing b = 11$
 $c = 12,5$



164.113 negro

$\varnothing a = 5,5$
 $\varnothing b = 14$
 $c = 15$



164.823 negro

$\varnothing a = 5,6$
 $\varnothing b = 9,7$
 $c = 9,5$



164.169 negro

$\varnothing a = 5,75$
 $\varnothing b = 15$
 $c = 19$



164.651 negro

$\varnothing a = 6$
 $\varnothing b = 14$
 $c = 13$



163.678 negro

$\varnothing a = 6$
 $\varnothing b = 12$
 $c = 18$



162.883 blanco

$\varnothing a = 6$
 $\varnothing b = 13$
 $c = 18$



163.173 negro

$\varnothing a = 6$
 $\varnothing b = 15$
 $c = 17$



163.217 gris

$\varnothing a = 6$
 $\varnothing b = 22$
 $c = 21$



163.099 negro

$\varnothing a = 6,2$
 $\varnothing b = 30$
 $c = 14$



163.385 negro

$\varnothing a = 6,5$
 $\varnothing b = 12$
 $c = 14$



162.823 negro

$\varnothing a = 6,5$
 $\varnothing b = 12$
 $c = 18$



162.447 negro

$\varnothing a = 6,5$
 $\varnothing b = 13$
 $c = 15$



162.705 negro

$\varnothing a = 6,5$
 $\varnothing b = 15$
 $c = 16,5$



164.204 negro

$\varnothing a = 6,5$
 $\varnothing b = 18$
 $c = 15$



162.643 negro

$\varnothing a = 6,5$
 $\varnothing b = 18$
 $c = 17$



162.806 negro

$\varnothing a = 6,5$
 $\varnothing b = 18$
 $c = 17$



163.386 negro

$\varnothing a = 6,5$
 $\varnothing b = 19$
 $c = 15$



162.815 negro

$\varnothing a = 6,5$
 $\varnothing b = 20$
 $c = 12$



163.308 negro

$\varnothing a = 6,5$
 $\varnothing b = 20$
 $c = 13,5$



162.450 negro

$\varnothing a = 6,5$
 $\varnothing b = 20$
 $c = 16$



162.975 negro

$\varnothing a = 6,5$
 $\varnothing b = 21$
 $c = 19$



163.879 negro

$\varnothing a = 6,5$
 $\varnothing b = 24,5$
 $c = 11$



163.327 negro

$\varnothing a = 6,5$
 $\varnothing b = 30$
 $c = 16$



163.129 negro

Ø a = 6,7
Ø b = 20
c = 14



163.006
negro

Ø a = 6,7
Ø b = 20
c = 14



163.490
gris

Ø a = 6,7
Ø b = 30
c = 17



163.007
negro

Ø a = 6,7
Ø b = 30
c = 17



163.489
gris

Ø a = 7
Ø b = 12,5
c = 17,5



162.454
negro

Ø a = 7
Ø b = 14
c = 16



162.221
negro

Ø a = 7
Ø b = 14
c = 16



162.222
gris

Ø a = 7
Ø b = 15
c = 13



162.493
negro

Ø a = 7
Ø b = 16
c = 20



163.630
negro

Ø a = 7
Ø b = 17
c = 15,5



163.890
negro

Ø a = 7
Ø b = 19
c = 27



163.878
negro

Ø a = 7
Ø b = 18,4
c = 11



164.109
negro

Ø a = 7
Ø b = 19
c = 11



162.453
negro

Ø a = 7
Ø b = 20
c = 13



162.908
negro

Ø a = 7
Ø b = 20
c = 16



162.660
negro

Ø a = 7
Ø b = 20
c = 18



162.935
negro

Ø a = 7
Ø b = 20
c = 25



163.742
negro

Ø a = 7
Ø b = 22
c = 25



162.657
negro

Ø a = 7
Ø b = 26
c = 24



163.087
negro

Ø a = 7
Ø b = 28
c = 16



163.079
negro

Ø a = 7,2
Ø b = 18
c = 14



163.174
negro

Ø a = 7,5
Ø b = 18
c = 20,5



164.375
negro

Ø a = 7,5
Ø b = 22
c = 28



164.376
negro

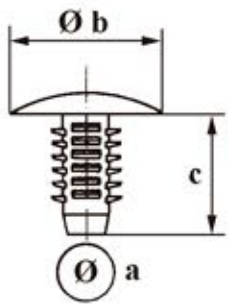

$\varnothing a$ = diámetro taladro
 $\varnothing b$ = diámetro cabeza
 c = altura fijación

261/

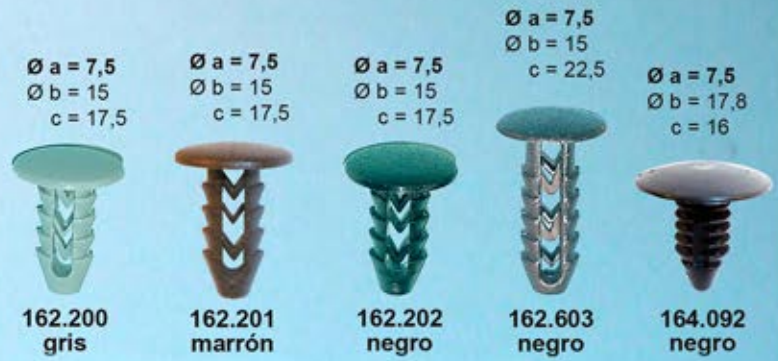

Ø a = 8
Ø b = 19,8
c = 24



163.971
negro

Ø a = 8
Ø b = 19,8
c = 24



163.972
gris

Ø a = 8
Ø b = 20
c = 13



162.780
negro

Ø a = 8
Ø b = 20
c = 14



163.722
negro

Ø a = 8
Ø b = 20
c = 20



162.782
negro

Ø a = 8
Ø b = 20,5
c = 18



163.837
negro

Ø a = 8
Ø b = 21,8
c = 17



164.059
negro

Ø a = 8
Ø b = 25,5
c = 45



164.627
negro

Ø a = 8
Ø b = 24
c = 17



163.494
negro

Ø a = 8
Ø b = 25
c = 12,5



162.658
negro

Ø a = 8,5
Ø b = 15
c = 12



162.959
negro

Ø a = 8,5
Ø b = 19
c = 30



163.887
negro

Ø a = 8,5
Ø b = 27
c = 27



163.216
negro

Ø a = 8,5
Ø b = 25
c = 11



164.661
negro

Ø a = 9
Ø b = 20
c = 18



162.354
negro

Ø a = 9
Ø b = 22
c = 21



162.512
negro

Ø a = 9,5
Ø b = 20,4
c = 30



164.407
negro

Ø a = 9,5
Ø b = 24
c = 20



164.662
negro

Ø a = 10
Ø b = 23
c = 16



162.781
negro

Ø a = 10
Ø b = 35
c = 23



162.656
negro

Ø a = 11
Ø b = 16
c = 18



162.968
negro

Ø a = 11
Ø b = 19,5
c = 17,5



163.964
negro

Ø a = 11
Ø b = 21,5
c = 28



163.744
negro

Ø a = 11
Ø b = 22
c = 25



162.611
gris

Ø a = 11
Ø b = 22
c = 25



162.613
negro

Ø a = 11
Ø b = 32
c = 24



163.008
negro

Ø a = 18
Ø b = 30
c = 29



162.894
negro

2 vías, Ø 3 x 3



190.501

2 vías, Ø 3 x 5



190.502

2 vías, Ø 4 x 5



190.503

2 vías, Ø 5 x 5



190.504

2 vías, Ø 5 x 5



190.517

2 vías, Ø 5 x 5 «corto»
con válvula



190.505

2 vías, Ø 5 x 5 «largo»
con válvula



190.506

2 vías, Ø 3 x 5
con válvula



190.512

2 vías, Ø 5 x 5
con válvula



190.507

2 vías, Ø 5 x 5
con válvula



190.515

3 vías, Ø 4 x 4 x 5



190.516

3 vías, Ø 5 x 5 x 5



190.508

3 vías, Ø 5 x 5 x 5



190.520

3 vías, Ø 5 x 5 x 5



190.518

3 vías, Ø 5 x 5 x 5



190.519

3 vías, Ø 5 x 5 x 5
con válvula



190.510

3 vías, Ø 6 x 6 x 6
con válvula



190.513

3 vías, Ø 5 x 5 x 5
con válvula



190.509

3 vías, Ø 6 x 6 x 6
con válvula



190.514

3 vías, Ø 5 x 5 x 5
con válvula



190.511

Ø 4,8 x 15
arandela Ø 15



161.473

Ø 4,8 x 18
arandela Ø 15



161.474

Ø 4,8 x 15
arandela Ø 15



161.832

Ø 5 x 25



161.831

Ø 6,3 x 19
arandela Ø 18



162.556

Ø 6,3 x 19
arandela Ø 22



161.743

Ø 6,3 x 14



161.739



161.793



161.715



161.716



161.717

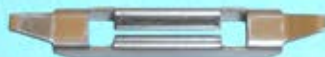

161.785



161.786

U.E.	DESCRIPCION	261	Ref. Adaptable
50	Tornillo Ø 4,8 x 15 (aro Ø 15), varios usos (ver varias marcas)	161.473	51 13 1 823 634
50	Tornillo Ø 4,8 x 18 (aro Ø 15), varios usos (ver varias marcas)	161.474	07 11 9 916 949
10	Tornillo fijación insonorizantes motor serie 3 (E46) (ver Mini)	161.715	51 71 8 212 148
10	Tornillo fijación tapa motor serie 5 (E39), serie 7 (E38), Z8 (E52)	161.716	51 71 8 218 323
10	Tornillo fijación tapa motor serie 5 (E39), serie 7 (E38)	161.717	51 71 8 218 852
25	Tornillo fijación varios usos BMW - varios modelos -	161.739	41 35 8 152 737
50	Tornillo Ø 6,3 x 19 (aro Ø 22), fijac. guardabarros (ver varias marcas)	161.743	
25	Fijación embellecedor parachoques trasero serie 6 (F12), X6 (apertura estrecha) (ver Ford, Mini)	161.785	07 14 7 054 461
25	Fijación embellecedor parachoques trasero X3 (F25) (apertura ancha)	161.786	07 14 9 241 763
10	Tornillo fijación cubierta culata serie 1 (E87), serie 3 (E90/91), serie 5 (E60/61), serie 7 (E65/66)	161.793	11 12 7 531 561
25	Tornillo Ø 5 x 25 fijac. placa matrícula BMW -varios modelos-	161.831	07 14 6 959 925 51 11 8 235 606
25	Tornillo Ø 4,8 x 15 (aro Ø 15), fijac. aletas BMW -varios modelos- (ver Mini)	161.832	07 11 9 901 299
50	Tornillo Ø 6,2 x 19 (aro Ø 18), sujeción guardabarros (ver Ford, Mercedes, Opel, VAG)	162.556	12 13 8 530 118 07 11 9 916 967



161.714



161.772



161.490



161.493



161.427



161.495



161.788



161.498



161.702



161.806



161.704



161.787



161.784



161.774



161.775



161.776



161.783

U.E.	DESCRIPCION	261	Ref. Adaptable
50	Clip fijac. parachoques tras. serie 5 (E60) (ver Opel, Renault, VAG)	161.427	23 07 0 22
50	Clip fijac. varios usos BMW - varios modelos - (ver Ford)	161.490	07 12 9 925 726
50	Clip fijac. varios usos BMW - varios - (ver Ford, Mercedes)	161.493	07 12 9 925 708
50	Clip fijac. varios usos BMW - varios modelos -	161.495	07 12 9 925 712
50	Clip fijac. guardabarros BMW - varios modelos - (ver Mercedes, VAG)	161.498	07 12 9 925 713 07 12 9 901 649
50	Clip fijac. guardabarros s.3 (E30), tapizados maletero s.5 (E34) y tapizados interiores s.5 (E39) (ver Mercedes)	161.702	07 12 9 925 737
50	Clip fijac. varios usos BMW - varios modelos - (ver Ford, Opel)	161.704	07 12 9 925 720
10	Tuerca fijación pasoruada y tapa motor s.5 (E39), s.7 (E38), Z8 (E52)	161.714	51 71 8 176 503
10	Tuerca fijación insonorizante motor serie 3 (E46), serie 5 (E60/E60N/E61/E61N), Z4 (E86) (ver Mini, VAG)	161.772	51 71 8 212 164 07 14 6 981 767
50	Fijación varios usos BMW - varios modelos - (ver Mini)	161.774	07 12 9 901 746 07 12 9 925 770
25	Fijación marco puerta trasera serie 1 (E87/E87N), y X1 (E84)	161.775	51 35 7 135 518
25	Fijación cubierta superior parabrisas X5 (E53) '00->'07	161.776	51 71 7 012 032
50	Fijación insonorizante motor serie 1 (F20/21), serie 3 (F30/31), X3 '09-> (F25) (ver Mini)	161.783	51 41 2 756 212
25	Fij. pasoruada y bajos serie 3 (E46), fij. parachoques trasero serie 1 (E81/87), serie 3 (E92/93), X1	161.784	07 14 7 154 227
25	Clip fijac. parachoques delantero y trasero X3 '03->'10 (E83/E83N)	161.787	51 12 3 413 810
50	Clip fijac. varios usos -varios vodelos-	161.788	07 12 9 904 150 07 12 9 901 656
50	Clip fijac. varios usos BMW - varios modelos - (ver Mini)	161.806	07 14 7 154 447

261/



163.844



162.294

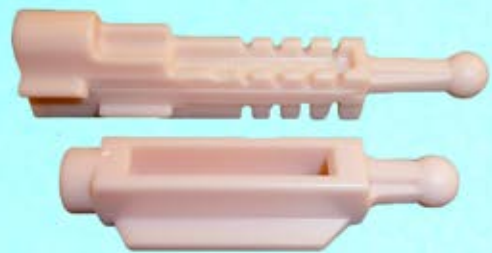

164.594



163.769



163.949



164.587



163.817



163.809



163.816



163.865

U.E.	DESCRIPCION		Ref. Adaptable
10	Fijac. moldura techo serie 5 '02-> (E60 / E60N)	163.809	51 13 7 064 097
10	Fijac. moldura techo serie 5 Touring '04->'10 (E61/E61N), X3 '09-> (F25), X5 '07->'13 (E70/E70N), X6	163.816	51 13 7 070 747
5	Fijac. moldura techo serie 5 Touring '04->'10 (E61/E61N), X5 '07->'13 (E70/E70N)	163.817	51 13 7 073 399
10	Fijac. moldura techo serie 5 Touring '05->'10 (E61/E61N)	163.865	51 13 7 073 396
25	Fijac. moldura techo X1 '08->'15 (E84)	163.949	51 13 2 992 450
10	Fijac. moldura techo Serie 1 '10-> (F20/21), Serie 2, Serie 3 '12-> (F30/31), Serie 4 (F32/33/36) '12->	164.587	51 13 7 291 271
50	Casquillo regulador faro BMW (ver VAG)	162.294	
1	Kit fijación regulador faro serie 5 (E39) '95->'00	163.769	63 12 0 027 924
10	Fijac. tornillo de ajuste faro serie 3 (E36), serie 6 (E63/E64), Z3	163.844	63 12 1 387 026
1	Kit fijación regulador faro serie 5 (E39) '00->'03	164.594	

261/

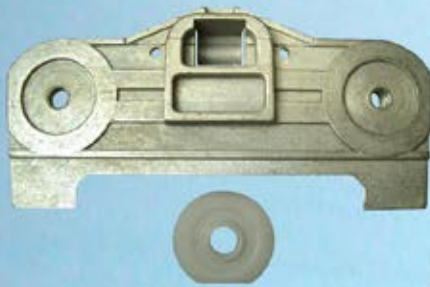

163.558*



163.983*

Dcho. / Izdo.



164.448*

Dcho. / Izdo.



164.402*

Dcho. / Izdo.



164.366*

Dcho. / Izdo.



163.055



163.556* - Dcho.
163.557* - Izdo.



163.984* - Dcho.
163.985* - Izdo.



163.986* - Dcho.
163.987* - Izdo.

* (imagen 1/2 tamaño real)

U.E.	DESCRIPCION		Ref. Adaptable
10	Fijación elevavinas serie 3 (E36 y E92), serie 5 (E34), Z3, Z4 (Eurocode 2431LSGSFD)	163.055	51 32 1 938 884
1	Soporte cristal elevavinas trasero derecho serie 3 (E46) '98->'05	163.556	
1	Soporte cristal elevavinas trasero izquierdo serie 3 (E46) '98->'05	163.557	
1	Soporte (aluminio) cristal elevavinas trasero dcho./izdo. serie 5 (E39)	163.558	
1	Kit soporte cristal elevavinas delantero serie 3 (E46) 2 puertas COMPACT	163.983	
1	Soporte cristal elevavinas trasero derecho serie 1 y serie 3 (E90/91) '05->, X1	163.984	
1	Soporte cristal elevavinas trasero izquierdo serie 1 y serie 3 (E90/91) '05->, X1	163.985	
1	Soporte cristal elevavinas trasero derecho X3 '03->	163.986	
1	Soporte cristal elevavinas trasero izquierdo X3 '03->	163.987	
1	Kit soporte cristal elevavinas delantero X5 '00->'07	164.366	
1	Kit soporte cristal elevavinas delantero serie 3 (E46) '98->'05	164.402	
1	Kit soporte cristal elevavinas delantero serie 3 (E90/91) '05->	164.448	



U.E.	DESCRIPCION	261	Ref. Adaptable
25	Fijac. parabrisas serie 5 ->'95 (E34) y serie 7 ->'94 (E32) (Eurocode 2426/2427ASCS)	162.945	51 31 1 938 494 51 31 8 177 850
50	Fijac. rejilla parabrisas "torpedo" serie 3 M3 (F80), serie 4 M4 (F82), X1 (F48) '14->, X2 (F39) '18->	163.045	51 11 8 174 185
50	Fijac. rejilla lavaparabrisas serie 5 (E34), serie 7 (E32), Z1 (Eurocode 2427ASCSB)	163.056	51 71 1 928 946
25	Fijac. rejilla parabrisas "torpedo" serie 3 (E36), serie 8 (E31) (Eurocode 2431ASCSB7B)	163.078	51 71 8 108 613
25	Fijac. torpedo parabrisas BMW serie 3 (E36), s.7 (E38), Z3 (Eurocode 2431/2433/2435ASCSB)	163.125	51 71 8 195 811
25	Fijac. torpedo parabrisas BMW serie 5 (E39), X5 (E53) (Eurocode 2434ASSH y 2434/2426ASCSB)	163.128	51 21 8 205 295
25	Fij. torpedo parabrisas serie 3 '11-> (F30/31/34), serie 4 '13-> (F32/33/36) (Eurocode 2465ASCSB)	163.392	16 13 6 753 087
25	Fijac. moldura lateral parabrisas X5 '07->'13 (E70), X6 '13-> (F16 / F86) (Eurocode 2452ASCRS)	163.711	51 13 7 177 926
25	Fijac. torpedo parabrisas serie 3 (E46), serie 7 (E65/66/67), s.5 (F07), X3 '03 (E83), Z4 (Eurocode 2443ASCSB) (ver Land Rover)	164.035	51 71 8 234 698
10	Fijac. moldura lateral parabrisas X6 (E71/E72) '07->'13 (Eurocode 2456ASCRS)	164.357	51 13 7 192 768
10	Fijac. moldura inferior derecha parabrisas X3 '10->'17 (F25) (Eurocode 2464ASCRR)	164.532	51 31 7 306 206
10	Fijac. moldura inferior izquierda parabrisas X3 '10->'17 (F25) (Eurocode 2464ASCRL)	164.533	51 31 7 306 205
10	Fijac. moldura inferior parabrisas X3 '10->'17, X4 (Eurocode 2464ASCRS)	164.593	51 31 7 255 727
5	Fijac. moldura parabrisas serie 4 '13-> (F33/F83) (Eurocode 2475ASCTS)	164.596	51 13 7 285 949
10	Fijac. moldura lateral parabrisas i3 '13-> (Eurocode 2470ASCHS)	164.757	51 33 7 310 542



163.347



163.348



163.349



163.058



163.863



163.775



163.776



163.777



164.467



164.540



164.609



164.811

U.E.	DESCRIPCION	261	Ref. Adaptable
10	Fijac. moldura cristal serie 7 ->'01 (E38) (Eurocode 2433ASCS)	163.058	51 31 8 125 892
25	Fijac. moldura parabrisas serie 3 '04->'11 (E90/E91) (Eurocode 2447ASCSS)	163.347	51 13 7 145 109
10	Fijac. moldura derecha parabrisas serie 3 '04->'11 (E90/E91) (Eurocode 2447ASCSS1B)	163.348	51 13 7 172 103
10	Fijac. moldura izquierda parabrisas serie 3 '04->'11 (E90/E91) (Eurocode 2447ASCSS2B)	163.349	51 13 7 145 110
10	Fij. moldura lateral parabrisas (parte inferior) serie 7 '07-> (F01/02/03/04) (Eurocode 2457ASCSDS)	163.775	51 13 7 157 702
10	Fij. moldura parabrisas (parte media) y luneta tras. s.7 (F01/02/03/04) (Eurocode 2457ASCSDS1B)	163.776	51 13 7 217 789
10	Fijac. moldura parabrisas - techo serie 7 '07->'14 (F01 / F02 / F03 / F04) (Eurocode 2457A)	163.777	51 13 7 184 575
25	Fijac. moldura parabrisas - techo serie 6 '11-> (F13/G32), fij. junta puerta s.1 '06-> (E81/E82/F21), s.2 (F22/23/87), s.3 Coupé '06-> (E92/F34), s.4 (F32/36/82), s.5 Gran Turismo '09->, (F07)	163.863	51 76 7 162 587
10	Fijac. moldura techo serie 7 '14-> (G11 / G12)	164.467	51 13 7 357 286
10	Fijac. moldura parabrisas X2 (F39) '18->	164.540	51 31 7 437 711
10	Fijac. moldura techo serie 5 '16-> (G30), M5 '17-> (F90), serie 7 '14-> (G11 / G12) (Eurocode 2485ASCSS1)	164.609	51 13 7 472 264
10	Fijac. moldura techo serie 5 '16-> (G31)	164.811	51 13 7 425 214

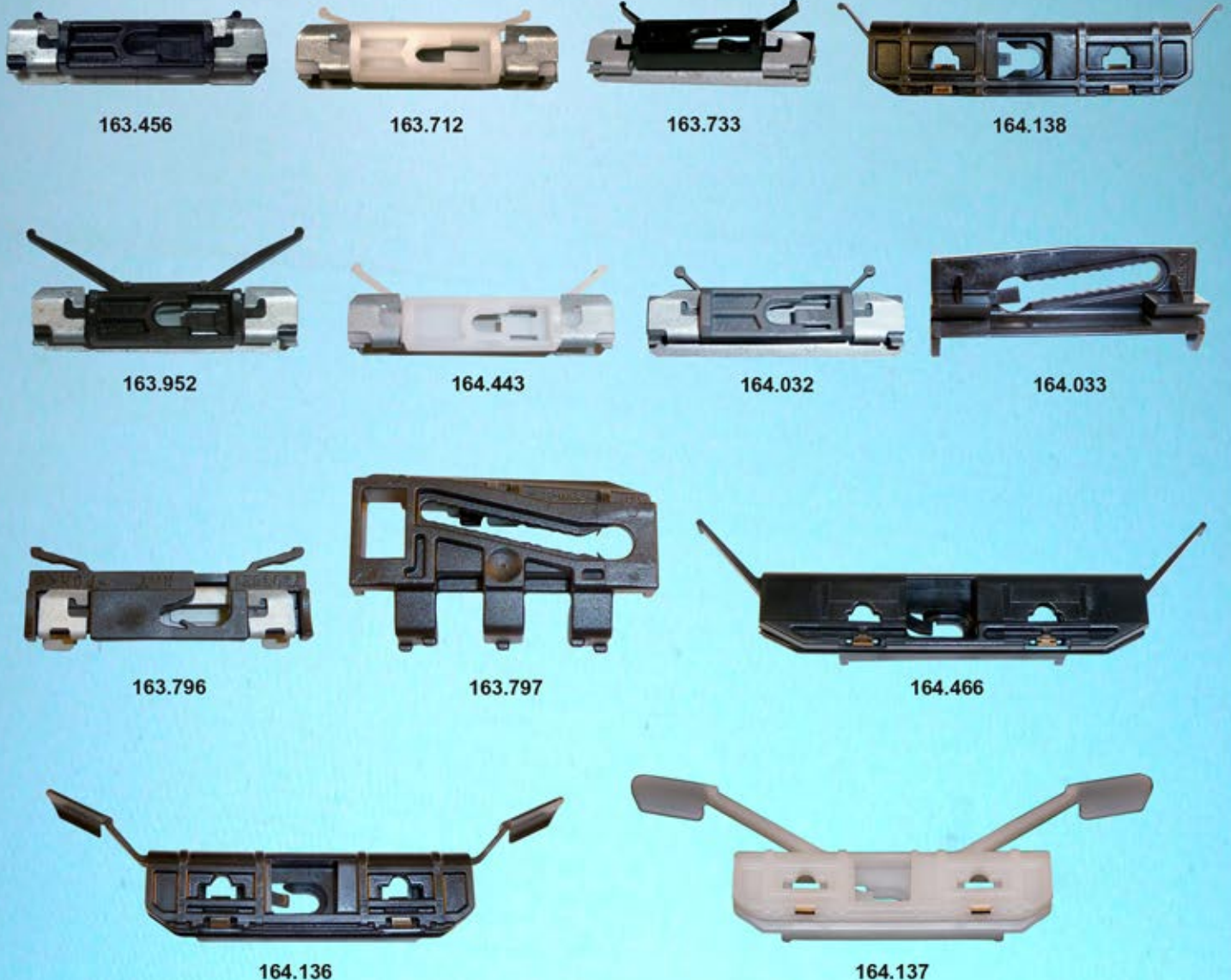

U.E.	DESCRIPCION	261	Ref. Adaptable
25	Fijac. moldura parabrisas s.5 '02->'09 (E60/E61), X5 '07->'13 (E70) y X6 (Eurocode 2445ASCSS)	163.456	51 31 7 064 098
10	Fijac. moldura lateral parabrisas X5 '07->'13 (E70) y X6 (Eurocode 2452ASCSS2B)	163.712	51 31 7 177 029
10	Fijac. moldura lateral parabrisas X3 '03->'10 (E83/83N) (Eurocode 2449ASCSS)	163.733	51 31 3 448 374 51 31 3 401 691
10	Fijac. moldura lateral parabrisas serie 5 '09->'16 (F10 / F11) (Eurocode 2459ASCSS)	163.796	51 13 7 209 821
10	Fijac. moldura parabrisas - techo serie 5 '09->'16 (F10 / F11)	163.797	51 13 7 238 257
10	Fijac. moldura lateral parabrisas X3 '10->'16 (F25), X4 '14->'16 (F26) (Eurocode 2464ASCSS6B) fijac. mold luneta trasera - techo s.7 (F01/F02/F04)	163.952	51 13 7 232 420
10	Fijac. moldura lateral parabrisas serie 7 '02->'08 (E65 / E66 / E67) (Eurocode 2443ASCSS6B)	164.032	51 13 7 195 479
10	Fijac. moldura lateral parabrisas serie 7 '02->'08 (E65 / E66 / E67) (Eurocode 2443ASCSS1B)	164.033	51 13 7 003 738
10	Fijac. moldura lateral parabrisas serie 2 '13->'16 (F45/46), serie 3 '11->'16 (F30/31/34/80), serie 4 (F32/33/36/82/83), X1 '14->'16 (F48), X3 '17->'16 (G01) (Eurocode 2465ASCSS)	164.136	51 13 7 258 183
10	Fijac. moldura lateral parabrisas serie 3 '12->'16 (F34), serie 4 (F32/33) (Eurocode 2471ASCSS)	164.137	51 13 7 321 818
10	Fijac. moldura lateral parabrisas X5 '13->'16 (F15) y X6 '13->'16 (F16) (Eurocode 2473ASCSS)	164.138	51 13 7 361 268
10	Fijac. moldura lateral parabrisas X3 '10->'17 (F25), X4 '14->'16 (F26) (Eurocode 2468ASC)	164.443	51 13 7 379 033
10	Fijac. moldura lateral parabrisas serie 5 '16->'16 (G30/31), M5 '17->'16 (F90), serie 7 '14->'16 (G11/12) (Eurocode 2481ASCSS)	164.466	51 13 7 357 283



163.457



163.458



164.040



164.041



163.819



163.772



163.394



163.290



163.365



163.842

U.E.	DESCRIPCION	261	Ref. Adaptable
50	Boca fijac. molduras serie 3 (E36 y E46), serie 5 (E39), serie 7 (E38)	163.290	51 13 1 960 127
50	Boca fijac. molduras serie 1 (E87), serie 3 (E46, E90, E91, E92), s.5 (E60 y E61), s.6 (E63 y E64), s.7 (E65, E66 y E67), X3 (E83/N)	163.365	51 71 1 932 996
50	Boca fijac. molduras laterales (ver Fiat y VAG)	163.394	
25	Fijac. moldura talonera serie 1 (E81/82/87/88), serie 3 (E90/91/92/93), serie 6 (F12), X1 y X6 (monta con 163.458)	163.457	07 14 7 122 912
25	Fijac. moldura talonera serie 1 (E81/82/87/88), serie 3 (E90/91/92/93), serie 6 (F12), X1 y X6 (monta con 163.457)	163.458	07 14 7 122 913
50	Boca fijac. moldura puerta-techo serie 1 (E81/82), serie 3 (E46, E92/93), serie 5 (F07), serie 6 (E63/64), serie 7 (E38), X5 (E53)	163.772	51 31 8 150 943
25	Fijac. moldura talonera serie 3 Coupé / Cabrio '06-> (E92 / E93)	163.819	07 14 6 965 447
50	Boca fijac. moldura talonera s.3 (E30), s.5 (E34), s.7 (E32/E38), fij. moldura marco puerta serie 5 (E39)	163.842	51 13 1 934 160
25	Fijac. moldura talonera puerta serie 5 (E60/61), serie 6 (E63/64) (monta con 164.041)	164.040	51 71 7 066 226
25	Fijac. moldura talonera puerta serie 5 (E60/61), serie 6 (E63/64) (monta con 164.040)	164.041	51 71 7 066 229

162.943

162.944

163.289

163.748

163.821

163.110

163.292

163.774

163.459

163.862

U.E.	DESCRIPCION	261	Ref. Adaptable
10	Fijac. molduras serie 3 (E36 y E46)	162.943	51 13 1 960 054
10	Fijac. molduras serie 5 (E39) y serie 7 (E38) (ver Fiat, Opel)	162.944	51 13 8 166 675
10	Fijac. moldura talonera serie 3 (E36 y E46)	163.110	51 71 8 184 574
10	Fijac. molduras serie 3 (E36)	163.289	51 13 2 251 394
10	Fijac. molduras serie 5 (518, 520, 524, 525, 528, 535, M5), 630, 635	163.292	51 13 1 875 898
25	Fijac. moldura talonera s.3 Coupé / Cabrio (E92 / E93), s.6 (E63 y E64)	163.459	51 77 7 170 955
10	Fijac. moldura lateral puerta serie 3 '98->'04 (E46)	163.748	51 13 8 231 130
25	Fijac. moldura talonera serie 3 '04-> (E90 / E91)	163.774	51 77 7 166 869
25	Fijac. moldura talonera serie 3 '04-> (E90 / E91)	163.821	51 77 7 891 250
25	Fijac. moldura talonera serie 5 '02-> (E60 / E61)	163.862	51 71 7 066 223



U.E.	DESCRIPCION	261	Ref. Adaptable
50	Fijac. panel puerta BMW - varios modelos - (ver Ford, VAG)	162.235	
50	Fijac. panel puerta serie 3 (E36 y E46), serie 5 (E34 y E39), serie 7 (E38), X5 (E53), Z3 y Z8	163.059	51 41 1 973 500 51 51 8 172 050
25	Fijac. panel puerta serie 5 (E39)	163.060	
25	Fijac. tapizados puerta serie 3 (E36)	163.465	51 41 2 155 030
50	Fijac. panel puerta serie 5 (E39), Z8 (E52)	163.751	51 41 8 172 050
25	Fijac. moldura talonera puerta serie 5 (E34 / E39)	163.770	51 47 8 234 047 51 47 1 928 808
50	Fijac. panel puerta serie 3 (E36 Cabrio, E46), serie 7 (E32/E38) (ver Mercedes)	163.773	51 41 8 101 204
50	Fijac. moldura pasoruada X3 (E83), fijac. talonera serie 3 (E30/E46), serie 5 (E28), X3	163.820	51 71 1 927 439
25	Fijac. faldón entrada puerta serie 3 Coupé (E92)	163.822	51 47 8 413 209
25	Fijac. moldura protección entrada puerta trasera serie 1 (E81/E82/E87), serie 3 (E90/91/93), serie 5 (E60/E61), serie 6 (E63/E64), x3 '09-> (F25), X5 '07-> (E70), X6	163.825	51 47 7 117 532
25	Fijac. moldura exterior pilar B serie 1 (E87/E87N) (ver Mini)	163.826	51 33 7 140 714
10	Fijac. moldura pasoruada X3 '09-> (F25), fijac. talonera puerta serie 7 (E38)	163.828	51 71 8 259 025
50	Fijac. faldón entrada puerta serie 1 (E82/88), serie 3 (E36/E46), s.5 (E34/E39/E60/61/F10/F11), serie 6 (E63/64), serie 7 (E38/E65/66/67/68/F01/02/03), X1, Z3, Z4	163.840	51 47 1 840 960
25	Fijac. faldón puerta serie 3 (E21/E30/E36)	163.841	51 47 1 840 961
50	Fijac. faldón entrada puerta serie 3 (E46/E90/E91/E93), serie 5 (E60/E61/F07)	163.928	51 47 8 244 458
25	Fijac. moldura talonera puerta X3 '10->, (F25), X5 '07-> (E70) y '13-> (F15), X6 (E71) (ver Mini)	164.034	51 77 7 171 003
25	Fijac. moldura talonera puerta y aleta trasera X2, X3 '10-> (F25), X5 '07-> (E70) y '13-> (F15), X6 (ver Mini)	164.036	51 77 7 171 002
25	Fijac. panel puerta serie 3 (E46/E90/91/92/93), X5 '00->'07 (E53)	164.042	07 14 9 158 194



U.E.	DESCRIPCION	261	Ref. Adaptable
50	Fijac. revestimientos maletero serie 3 (E36 y E46), serie 5 (E34 / E39 y E61), fijac. tapizados interiores serie 7 (E65/66), X3 (ver Ford, Mini)	161.420	51 49 8 123 832
50	Fijac. revestimientos interiores E23, E24, E28 (ver Ford, Opel, VAG)	162.782	51 47 1 904 317
50	Fijac. tapizados interiores serie 3 (E36), serie 5 (E34 y E39), s.7 (E32)	163.061	51 48 8 181 420
25	Fijac. cierre rápido BMW - todos los modelos -	163.077	51 71 1 916 197
25	Fijac. alfombrillas serie 3 (E46), serie 5 (E34, E39), serie 7 (E32, E38)	163.746	82 11 9 710 191
25	Fijac. revestimientos interiores serie 3 (E46), X3 (E83), X5 (E53), Z4 (E85/E86)	163.747	51 43 8 225 567
25	Fijac. panel puerta s.1 (E82), s.3 (E46, E90/91/92/93), s.5 (E60N/61N), s.7 (E65/66/67, F01/02/03), X1, X2, X3 (E83, F25), X5 (E53), X6 (ver Mini)	163.750	51 41 8 224 768
25	Fijac. panel puerta serie 1 (E88), serie 3 (E36 Cabrio, E46, E90/91/92/93), serie 5 (E60/E61), serie 6 (E63/E64), X1, X3 (E83, F25), X5 (E53, E70), X6 (ver Mini)	163.752	51 41 8 224 781
25	Fijac. panel puerta serie 5 (F07/F10/F11), serie 6 (F12), serie 7 (F01/F02), fijac. tapizados maletero X5 (E70) (ver Mini)	163.753	07 14 7 145 753
50	Fijac. revestimientos interiores serie 1 (E81/82/87), serie 3 (E90/91/92), serie 5 (F07/10/11), serie 7 (F01/02/03), X1	163.818	07 14 7 152 593
10	Fijac. tapizados puerta X3 '09-> (ver Mini)	163.823	51 25 2 753 575
25	Fijac. panel puerta serie 3 (E90N/E91N)	163.829	51 41 7 211 653
50	Fijac. panel puerta serie 3 (E46), fijac. tapiz. interiores serie 1 (E81/82/87/88), s.3 (E90/91/92/93), s.5 (F07/10/11), s.7 (F01/02/03/04), X1, X2, X3 (F25), X5 (E70), X6 (ver Mini)	163.843	51 43 7 001 491
25	Fijac. agarradero tapa maletero serie 3 (E46) (ver Mini)	163.849	07 17 7 141 218
25	Fijac. panel puerta X5 '07->'13 (E70/E71), X6 y Z4 (ver Mini)	164.038	07 14 9 136 882
50	Fijac. panel puerta serie 3 (E90/91/92/93), serie 5 (E60/61), serie 6 (E63/64), Z4 (ver Mini)	164.039	07 14 6 962 771
50	Fijac. tapizados interiores serie 5 (F10/11), serie 6, serie 7 (E65/66/67/F01/02/03/04), I3 '13->	164.057	51 41 7 046 415
50	Fijac. tapizados interiores serie 1 (E87/88/F20/21), serie 3 (E46/E90/91/92/93/F30/31), X1, X3 y X5	164.072	52 20 1 964 201
25	Fijac. panel puerta X1 '09->'14 (E84), fijac. tapizados techo X3 '17-> (G01), fijac. moldura puerta X1 '14-> (F48), X2 (F39) (ver Mini)	164.295	07 14 2 754 954 07 14 7 443 710
25	Fijac. tapizados interiores serie 1 (E88), s.2 (F23), s.3 (E93), s.4 (F33/83), s.6 (F12)	164.789	07 14 6 955 627



163.950



163.951



163.749



163.801



163.062



163.460



164.026



163.153



162.918



181.597*

Dcho. / Izdo.



181.599*

Dcho. / Izdo.



181.600*

Dcho. / Izdo.

U.E.	DESCRIPCION	261	Ref. Adaptable
10	Fijac. cableado BMW - varios modelos - (ver Ford, Opel)	162.918	
25	Fijac. varilla puerta serie 3 (E36), serie 5 (E34 y E39), serie 7 (E32 y E38) y Z3	163.062	51 22 1 817 032
10	Fijac. spoiler delantero serie 3 (E30)	163.153	51 71 1 945 568
50	Boca fijac. emblemas BMW - todos los modelos -	163.460	51 14 1 807 495
25	Fijac. moldura vierteaguas puerta serie 3 '98->'04 (E46)	163.749	51 13 8 204 858
25	Fijac. junta moldura puerta serie 3 '04-> (E90 / E91)	163.801	51 13 7 117 240
25	Fijac. junta puertas X5 '00->'07 (E53)	163.950	51 33 7 052 945
25	Fijac. junta puertas y junta frontal capó X5 '00->'07 (E53), serie 7 '02-> (E65/E66/E67/E68)	163.951	51 71 7 006 757
25	Fijac. varios usos - varios modelos - (ver Ford, VAG)	164.026	
1	Kit leva cerradura puerta derecha e izquierda Serie 3 (E46) '98->'05	181.597	
1	Kit leva cerradura puerta derecha e izquierda X5 '00->'07	181.599	
1	Kit leva cerradura puerta derecha e izquierda Serie 3 (E90/91/92/93) '05->'12	181.600	



U.E.	DESCRIPCION	261	Ref. Adaptable
50	Fijac. pasoruedas, revestimientos y otros usos serie 1 (E87), serie 3 (E90/E91/E92), Z3 (ver VAG)	162.921	
50	Fijac. revestimientos s.3 (E36 y E46), s.7 (E65, E66, E67 y E68), X3 (E83 y E83N), X5 (E53) y Z4 (ver Ford, Mini, Opel, VAG)	162.948	
25	Taco para fijac. tornillo Ø 3,5 serie 5 (E34) (ver Mercedes)	163.063	51 13 8 102 952
50	Fijac. soporte placa matricula S.1, S.2, S.3, S.4, S.5, S.6, S.7, X1, X3, X4, X5, X6 (ver VAG)	163.178	51 12 7 020 321
50	Fijac. pasoruedas y revestim. s.1 (E87), s.3 (E36, E46, E90, E91, E92), s.5 (E34, E39, E60, E61), s.7 (E65, E66, E67, E68), X3, X5 (E53) (ver Mercedes, Mini)	163.288	16 13 1 176 747
50	Fijac. revestimientos maletero serie 3 (E91) y serie 5 (F07) (ver VAG)	163.350	07 14 6 969 296
50	Fijac. pasoruedas serie 1 (E87), s.3 (E36, E46, E90, E91, E92), s.5 (E34, E60, E61) (ver Mini)	163.454	51 16 1 943 122
50	Fijac. pasoruedas serie 1 (E87), serie 3 (E36, E46, E90, E91, E92), serie 7 (E65, E66, E67), X3 (E83, E83N), X5 (E53), Z3, Z4 (Ø exterior 23,8 mm)	163.455	51 71 1 958 025
25	Fijac. soporte matrícula trasero serie 3 (E46), serie 5 (E60), X5 (E53) (ver Mini)	163.848	51 18 8 242 693
25	Fijac. talonera puerta, tapizados interiores y otros usos -varios modelos-	164.065	63 17 1 367 868
50	Fijac. bajos carroceria serie 1, serie 3 (E90/91/92, F30/31), serie 4 (F32/33), serie 5 (F10/11), X1	164.142	07 14 6 976 114
25	Fijac. pasorueda y otros usos S.1 '16->, S.3 '11->, S.4, S.5 '08->, S.6, S.7, X1, X2, X3 '09->, X4 (ver Mini)	164.626	07 14 7 201 307
50	Fijac. insonorizante motor S.1, S.2, S.3, S.4, S.5, S.6, S.7, X1, X3, X4, X5, X6 (ver Mini)	164.639	51 48 9 119 216
50	Fijac. parachoque, pasorueda y tapiz. interiores S.1, S.2, S.3, S.4, S.5, S.6, S.7, X1, X3, X5, X6, i3	164.644	51 71 7 154 520
25	Fijac. tapizados interiores S.3 (E36, E46, E90/91/93), S.5 (E39, E60), S.6 (E63/64)	164.684	51 71 1 916 199
25	Fijac. soporte parachoques trasero y otros usos serie 1 (E81/87), s.3 (E46), s.5 (F10/11), s.6 y s.7, X1, X3, X4, X5, X6 y Z4 (E89) (ver Mini)	164.730	51 12 7 046 911
25	Fijac. insonorizante motor S.1, S.2, S.3, S.4, S.5, S.6, S.7, X1, X2, X3, X4, X5, X6, Z4 (ver Mini)	164.814	51 48 8 126 849
50	Fijac. pasorueda y bajos carroceria S.1, S.2, S.3, S.4, S.5, S.6, S.7, X1, X2, X3, X4, X5, X6 (ver Mini)	164.818	07 14 7 169 847

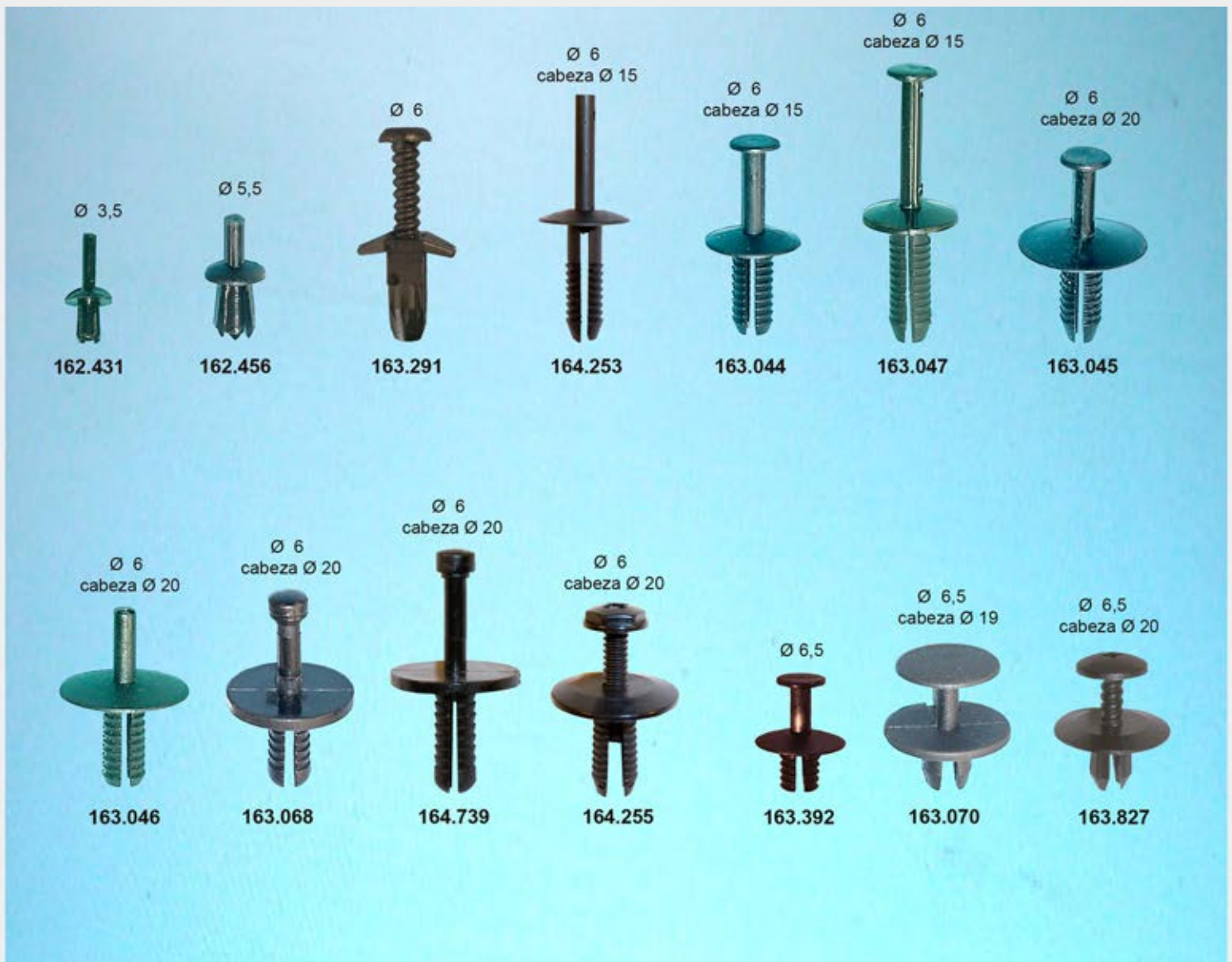

U.E.	DESCRIPCION	261	Ref. Adaptable
100	Fijac. varios usos (ver Mercedes, Opel, PSA, VAG)	162.431	
50	Fijac. pasorueda s.1 (F20/21), s.2 (F22/23/87/45/46), s.3 (E46/F30/31/34/80), s.4 (F32/33/36/82/83), s.5 (E39,60,61,65,66,67, F01,02,03,04,07,10,11), s.6 (F12/13), s.7 (F01/02/03), X1, X2, Z4 (E89), fijac. bajos carroceria serie 1 (E81,82,87,88), serie 3 (E90,91,92,93), X1 y otros usos X5, X6 (ver Mercedes, PSA, Renault, VAG)	162.456	51 16 1 881 149
50	Fijac. revest. interiores y parachoques - todos - (ver Land Rover, Mercedes, Mini, Smart, VAG)	163.044	51 11 1 908 077
50	Fijac. pasorueda serie 1 (F20/21), s.2 (F22/23/87), s.3 (F30/31/34/80), s.4 (F32/33/36/82/83), X5 fijac.parachoques serie 3 (E46), s.5 (E39), s.7 (E38), X3 (E83/83N), X5 (E53), Z3 y Z4, fijac. rejilla parabrisas serie 3 M3 (F80), serie 4 M4 (F82), X1 (F48), X2 (F39) (ver Mini)	163.045	51 11 8 174 185
50	Fijac. parachoques serie 3 (E36, E46), s.5 (E34, E39), s.7 (E38), X3 (E83/83N), X5 (E53), Z3 y Z8	163.046	51 11 1 944 537
50	Fijac. parachoques serie 3 (E30, E36, E46), serie 5 (E39, E60), s.7 (E38), X5 (E53) (ver Opel)	163.047	51 11 1 964 186
25	Fijac. rápida - varios usos - serie 3 (E30), serie 5 (E28)	163.068	51 48 1 884 779
25	Fijac. rápida - varios usos - serie 3 (E30, E34), serie 5 (E39), serie 7 (E32, E38, E65,66,67,68), Z3	163.070	51 48 1 938 725
50	Fij. rejilla lavaparabr. s.3 (E36), s.5 (E34/39/60/61), s.6 (E63, E64), s.7 (E38/65/66/67/68), X5 (E53)	163.291	51 13 1 885 399
25	Fij. torpedo parabrisas serie 3 '11-> (F30/31/34), serie 4 '13-> (F32/33/36) (Eurocode 2465ASC5B)	163.392	16 13 6 753 087
50	Fijac. torpedo parabrisas serie 5 '10-> (F07/10/11), fijac. parachoques delantero serie 5 (E34), fijac. tapizados maletero s.3 (E36), s.5 (E60), X5 (E53), fijac. insonorizante motor s.1 (F20/21), s.3 (E46/E90/91/92/93/F30/31/34), s.4 (F32/33/36) (ver Mini)	163.827	51 48 1 915 964
50	Fijac. guia de aire serie 3 (E46), serie 5 (E39)	164.052	51 71 8 229 003
50	Fijac. parachoque serie 3 (E46)	164.253	51 11 7 068 126
25	Fijac. talonera puerta serie 5 (F07/10/11), s.6 (F12/13), s.7 (E38/E65/F01/02/03/04) (ver Mini)	164.255	51 71 8 259 788
25	Fijac. tapa filtro aire serie 3 (E46/E90), s.5 (E39), X1 (E84), X5 (E53/70), X6	164.739	51 47 1 919 209

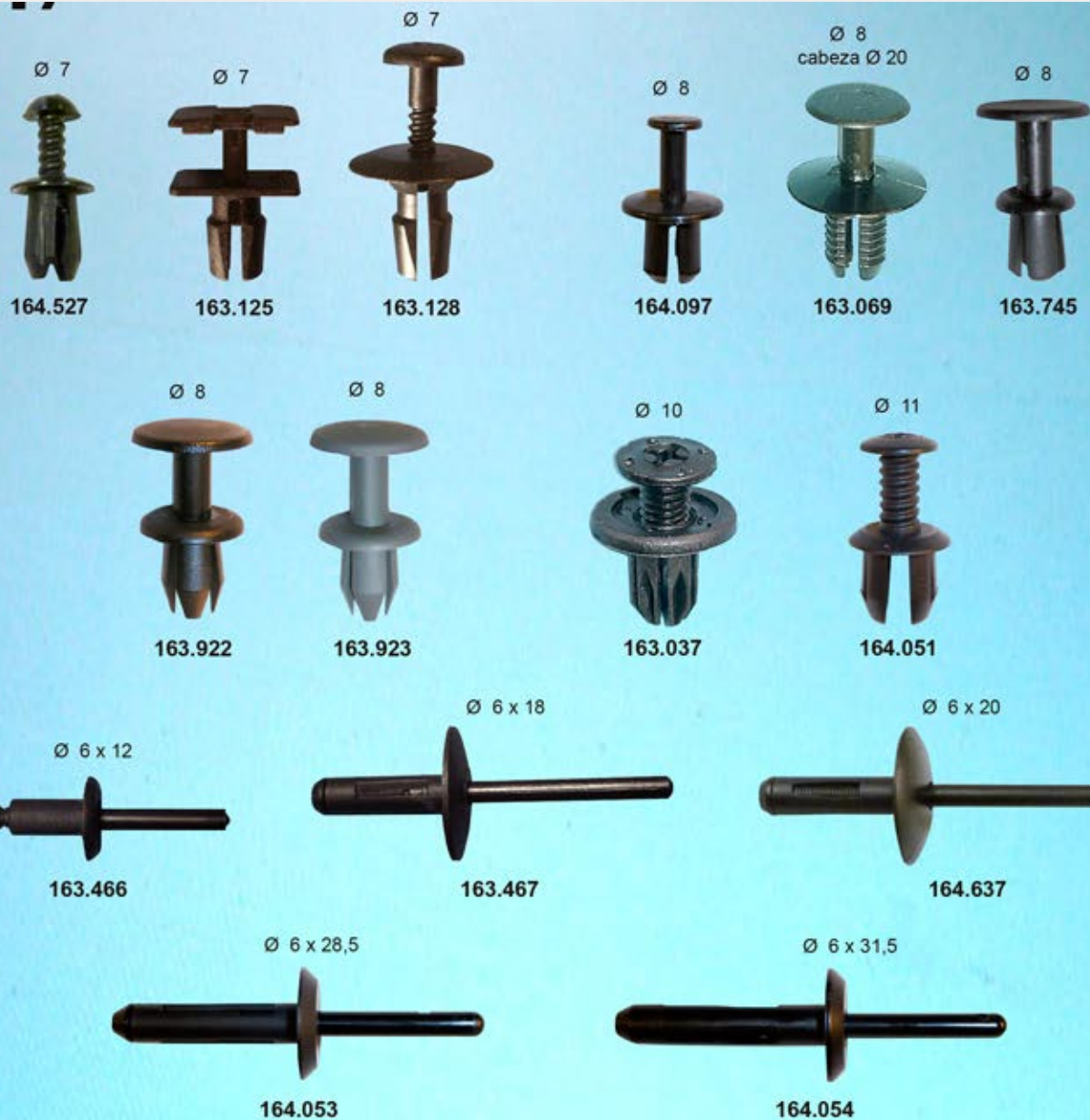

U.E.	DESCRIPCION	261	Ref. Adaptable
50	Fijac. bajos carroceria serie 1 (E81, E82 y E88), fijac. talonera puerta Serie 2, X1 (F48), X2 (F49) (ver Chevrolet, Honda, Mini, Rover)	163.037	07 13 0 702 966
25	Fijac. torpedo parabrisas S.5 '10-> (F10/11/18), S.6 (F06/12/13) (ver Mercedes, Mini, VAG, Volvo)	163.069	51 47 1 911 992
25	Fijac. torpedo parabrisas BMW serie 3 (E36), s.7 (E38), Z3 (Eurocode 2431/2433/2435ASCBS)	163.125	51 71 8 195 811
25	Fijac. torpedo parabrisas BMW serie 5 (E39), X5 (E53) (Eurocode 2434ASSH y 2434/2426ASCBS)	163.128	51 21 8 205 295
25	Fijac. parachoques delantero serie 3 (E46) y talonera serie 3 (E30)	163.466	51 11 1 942 789
25	Fijac. pasorueda serie 3 (E90/E91 335i Touring), X1 (E84/F48), X2 (F39), X3 (E83/E83N/F25/G01), X4, X5 (E53/E70), X6 y Z4 (E85/E86)	163.467	51 77 7 171 004 51 71 7 002 953
25	Fijac. tapizados interiores serie 1 (E81/E82/E87/E88), serie 3 (E36, E46, E92/E93), serie 5 (E39, E61), X6, Z3, serie 6 (E63/E64), serie 7 (E38, E65/E66) (ver Mercedes, VAG)	163.745	51 49 8 166 702
50	Fijac. revestim. maletero s.1 (E82/E88), s.5 (E60/60N y F07), s.6 (E63/64), X5 (E70), X6, Z4 (E89)	163.922	07 14 7 136 172
50	Fijac. revestim. maletero s.1 (E88), s.3 (E46 y E90/E92/E93), s.6 (E61/E61N), s.7 (F01/02/03/04)	163.923	51 49 8 237 075
25	Fijac. compartimiento motor s.5 (E39), fij. tapiz. maletero s.3 (F30), s.4 (F32), s.5 (F11) (ver Ford)	164.051	51 71 8 229 000
25	Fijac. moldura aleta X3 '10-> (F25), X5 '07-> (E70) y X6 (ver Chrysler)	164.053	07 14 2 151 750
25	Fijac. moldura aleta, talonera puerta y tapiz. interiores X5 '07-> (E70) y '13-> (F15) y X6	164.054	07 14 9 140 786
50	Fijac. tapizados interiores serie 3 (E46) (ver VAG)	164.097	17 11 1 712 963
50	Fijac. soporte capó s.1, s.2, s.3, s.5, s.6, s.7, X1, X3, X5, X6 (ver Mini)	164.527	51 16 8 197 908
25	Fijac. moldura aleta X3 '09-> (F25), X4, X5 '12-> (F15), X6 '13-> (F16)	164.637	07 14 7 293 278

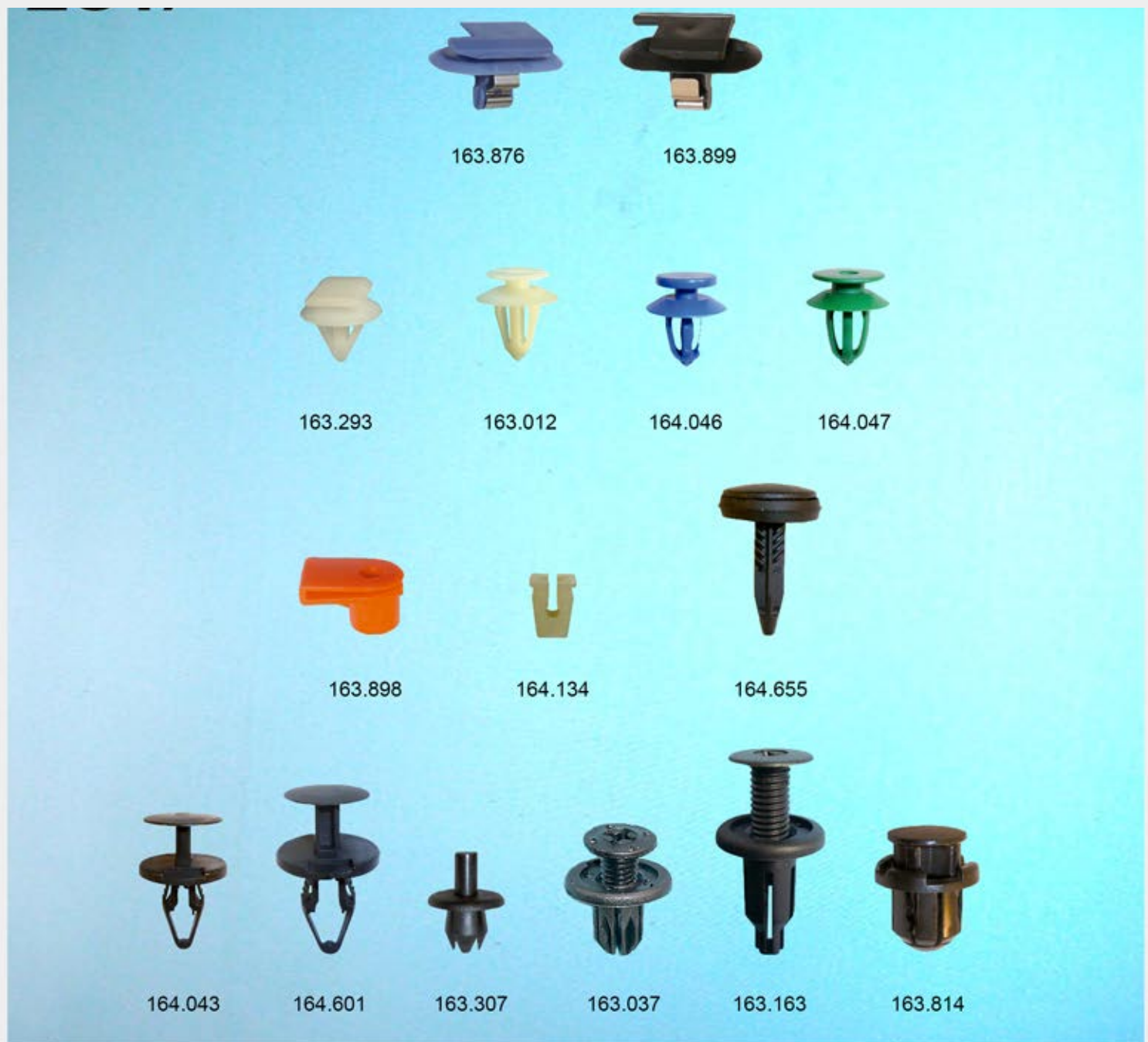

U.E.	DESCRIPCION	261	Ref. Adaptable
25	Fijac. tapizados interiores Nexia (ver Opel)	163.012	90244506 90321122
25	Fijac. tapizados Matiz - y otros -	163.293	94530542
25	Fijac. tapizados interiores Camaro, Caprice, Pontic, Volt (ver Opel, PSA, Renault)	163.876	24405740
25	Fijac. tapizados interiores Camaro, Caprice, Cruze, Pontic, Volt (ver Opel)	163.899	24405739
50	Fijac. panel puerta Equinox, Volt (ver Opel)	164.046	13252118
50	Fijac. panel puerta Cruze, Equinox (ver Opel)	164.047	13252119
50	Fijac. parachoques Matiz, Nubira - y otros - (ver BMW, Honda, Mini, Rover)	163.037	94530623
25	Fijac. parachoques Captiva, Nubira, Leganza (ver Honda)	163.163	94530624
100	Fijac. tapizados y pasoruada - Aveo, Kalos, Lanos (ver Opel)	163.307	94530507
25	Fijac. varios usos -varios modelos- (ver Fiat, Suzuki)	163.814	
50	Fijac. parachoque delantero Cruze (ver Opel)	163.898	24449408
50	Fijac. parachoque y otros usos Aveo, Cruze, Equinox, Volt (ver Ford, Opel)	164.043	11589289
50	Fijac. tapizados interiores y otros usos Aveo '04->, Cruze '11-> (ver Opel)	164.134	94515248
25	Fijac. parachoque delantero y trasero Camaro '10, Cruze '11, Equinox, Orlando '12, Spark '13, fijac. pasoruada Spark '13-> (ver Ford, Opel)	164.601	11589293
10	Fijac. rejilla parabrisas "torpedo" Trax '13-> (Eurocode 6337ASCRB) (ver Opel)	164.655	11546904



U.E.	DESCRIPCION	261	Ref. Adaptable
50	Fijac. parachoques delantero y parrilla radiador Chrysler PT Cruiser, Dodge Journey, Neon, Nitro, Jeep Grand Cherokee '05->'10, Commander '06->, Wrangler '07-> (ver Ford, Opel, Renault, VAG)	163.091	06503598
25	Fijac. aletas y moldura puerta Grand Cherokee '05->'10 y '11->, Commander, Wrangler (ver BMW)	164.053	06500911
25	Fijac. panel puerta Chrysler Voyager '01->'03, Grand Voyager '96->'07, Dodge Caravan '96->'07, Nitro '10, Jeep Grand Cherokee '99->'01	164.249	06505539AA 06503204
10	Fijac. panel puerta Jeep Grand Cherokee '93->'05, fij. tapizados maletero Dodge Journey '13->	164.250	06502991
25	Fijac. panel puerta Chrysler Voyager '01->'03, Grand Voyager '96->'07, Dodge Caravan '96->'07, Nitro '10, Jeep Grand Cherokee '10	164.251	06505292AA
25	Fijac. pasoruada y tapizados interiores Chrysler Voyager, PT Cruiser, Dodge Caliber, Caravan, Journey, Jeep Cherokee ->'01, Grand Cherokee '93->'01 y '09->'13, Compass	164.375	06030441
25	Fijac. parachoque, pasoruada y tapizados interiores Chrysler Voyager, Grand Voyager '97->'03, Dodge Caravan, Journey, Jeep Compass '11->, Grand Cherokee '05->, Patriot '11, Wrangler '08	164.376	06501916
25	Fijac. panel puerta Jeep Grand Cherokee '06->'12	164.377	55116997AB
10	Fijac. panel puerta Dodge Journey '11->, Jeep Cherokee '06->'12 (ver Fiat)	164.404	68045836AA 05023351AA
25	Fij. pasoruada Grand Caravan '13, Journey '11, fij. insonoriz. capó Grand Cherokee '10 (ver Fiat)	164.405	06504521
25	Fijac. moldura aleta y tapizados puerta Dodge Journey '11-> (ver Fiat)	164.406	06509103AA
25	Fijac. parrilla radiador Dodge Journey '11-> (ver Fiat)	164.415	06509135AA
25	Fijac. insonorizante capó Chrysler PT Cruiser, Dodge Caliber, Challenger, Journey '11->, Jeep Compass '08, Grand Cherokee '09->'13, Patriot (ver Fiat)	164.432	04878883AA
25	Fijac. panel puerta Jeep Renegade '14-> (ver Fiat)	164.849	52034852
25	Fijac. tapizados interiores Jeep Renegade '14-> (ver Fiat)	164.852	52078320
10	Fijac. moldura puerta Jeep Renegade '14->	164.854	52064478
10	Fijac. moldura puerta Jeep Renegade '14->	164.855	52003457
10	Fijac. moldura puerta Jeep Renegade '14->	164.856	52068106



163.263



163.264



163.265

U.E.	DESCRIPCION	261	Ref. Adaptable
10	Fijac. moldura pasoruada Feroza, Terios	163.263	90044-67395-000
10	Fijac. parrilla radiador Feroza, Terios	163.264	90044-67376-000
10	Fijac. bisagra puerta Feroza, Terios	163.265	90044-68025-000



161.750



161.727



161.724



161.731



162.711



164.465



164.521



164.391

U.E.	DESCRIPCION	261	Ref. Adaptable
25	Tornillo Ø 6 x 20 (aro Ø 22), fijac. parachoques delantero Logan (ver Renault)	161.724	7703 602 206 7703 602 060
25	Tornillo Ø 6 x 20 (aro Ø 18), fijac. aleta delantera Logan y Sandero (ver Opel, Renault)	161.727	7703 602 282
25	Tornillo Ø 6 x 28 (aro Ø 24), fijac. parachoques trasero Sandero (ver Renault)	161.731	7703 602 059
25	Tornillo Ø 5 x 22 (aro Ø 16), fijac. parachoques y moldura puerta Logan, Sandero, Lodgy y Dokker, fijac. pasoruada Duster (ver Opel, Renault)	161.750	7703 017 090
25	Tuerca con aro móvil (Ø 6), fij. emblema trasero Duster (ver Ford, Opel, PSA, Renault, VAG)	162.711	7703 033 156
10	Fijac. tope cala luneta tarsera Duster, Logan, Sandero (ver Renault)	164.391	9035 627 59R 8200 048 913
10	Fijac. bajos carroceria Duster (ver Renault)	164.465	7703 041 045
5	Tope (goma) capó Dokker, Duster, Logan I y II, Sander I y II (ver Renault)	164.521	8200 048 938



163.491



163.082



163.727



163.453



163.881



163.222



163.883



164.361



164.301



163.666* - Dcho.
163.667* - Izdo.



164.845 *- Izdo.



164.844 *- Dcho.

* (imagen NO a tamaño real)

U.E.	DESCRIPCION	261	Ref. Adaptable
50	Fijac. panel puerta Logan (ver PSA, Renault, VAG, Volvo)	163.082	7701 056 846
25	Taco fijac. revestimientos interiores Logan (ver Fiat, Opel, PSA, Renault)	163.222	7703 081 185
50	Fijac. rejilla calandra Dacia Dokker (ver Fiat, PSA, Renault)	163.453	8200 700 969
50	Fijac. panel puerta Logan	163.491	6001 549 265
1	Soporte cristal elevalunas delantero derecho Dacia Logan (ver Renault)	163.666	
1	Soporte cristal elevalunas delantero izquierdo Dacia Logan (ver Renault)	163.667	
50	Fijac. panel puerta Lodgy, Sandero II '13-> (ver Mini, PSA, Renault)	163.727	8200 909 084
50	Fijac. moldura inferior puerta Sandero II '13-> (ver PSA, Renault)	163.881	7703 081 233
50	Fijac. panel puerta Lodgy (ver PSA, Renault)	163.883	7703 081 225
25	Fijac. moldura inferior puerta Sandero II '13-> (ver Renault)	164.301	7703 081 223
25	Fijac. parachoque trasero Sandero II '13-> (ver Renault)	164.361	7703 081 239
1	Soporte parachoque delantero derecho Sandero I '08->'12	164.844	8200 735 119
1	Soporte parachoque delantero izquierdo Sandero I '08->'12	164.845	8200 735 118



Ø 6,7

163.006



Ø 6,7

163.490



Ø 6,7

163.489



Ø 11

163.008



163.320



164.303



Ø 9

164.468



Ø 10

162.941



Ø 10

163.906



tornillo Ø 5

163.830



Ø 6

163.140



Ø 8,2

163.088



Ø 8,2

164.254

U.E.	DESCRIPCION	261	Ref. Adaptable
25	Botón fijac. pasoruada Logan I (ver Ford, PSA, Renault)	162.941	7703 081 054
50	Fijac. insonorizante capó y fijac. alfombras Logan, Sandero, Duster (ver Renault)	163.006	7703 077 117
50	Fijac. pasoruada y protector parachoques delantero Logan, Sandero, Duster, Lodgy (ver Renault)	163.008	7703 077 435
50	Fijac. rejilla calandra y protector parachoques delantero Dokker, Duster, Logan y Sandero, fij. parachoque trasero Lodgy (ver Nissan, Opel, Renault)	163.088	7703 072 360
50	Fijac. pasoruada Sandero (ver Fiat, Opel, Renault)	163.140	7703 072 361
50	Fijac. insonorizantes y pasoruada Logan, Sandero, Duster y Lodgy (ver Renault)	163.320	7703 081 056
50	Fijac. tapizados interiores Logan (gris)	163.489	6001 546 909
50	Fijac. tapizados interiores Logan	163.490	
50	Fijac. aleta trasera Duster (ver Fiat, Ford, Mercedes, Smart)	163.830	8200 888 543
25	Fijac. pasoruada trasero Duster, fijac. insonorizante y tapizados interiores Duster, Logan, Lodgy, Sandero 1 y 2, (ver Renault)	163.906	7703 081 227
25	Fijac. rejilla parabrisas Dacia Dokker, Duster, Logan, Sandero (ver Nissan, Renault)	164.254	0540 000 01R
50	Fijac. pasoruada Sandero II '13-> (ver Renault)	164.303	7703 081 237
25	Fijac. pasoruada trasero Logan II, Sandero II '13-> (ver Renault)	164.468	7703 081 127



U.E.	DESCRIPCION	261	Ref. Adaptable
50	Tornillo fijac. revestimiento pasoruada Bravo/a, Marea, Punto y fijac. tapizados interiores Bravo/a, Ducato '94, Grande Punto '05	161.453	11877207 15691007
50	Tornillo fijac. panel puerta y revestimientos Alfa Romeo 147, Fiat Dobló, Multipla, Punto '99 y '03, Seicento, Lancia Y, Ypsilon	161.454	7751170
25	Tornillo fijac. guardabarros Tipo, Tempra, Marea, Bravo/a, Cinquecento, Nuevo Delta, Dedra	161.456	7558952
25	Tornillo en jaula fijac. guardabarros Uno, Bravo/a, Marea	161.457	14660690
50	Tornillo fijac. bisagra puerta Alfa Romeo 147, 155, 156, Fiat Bravo/a, Multipla, Punto '99 y '03, Tipo, Tempra, Lancia Delta, Lybra, Kappa, Y, Ypsilon (ver Renault)	161.706	7658843
25	Tornillo fijac. parachoques Alfa Romeo 145, 146, 147, 156, 159, 166, Brera, Fiat Dobló, Ducato, Grande Punto, Marea, Multipla, Palio, Panda '03, Punto '99 y '03, Seicento, Siena, Strada, Lancia Lybra, Thesis, Y, Ypsilon	161.752	46419734
25	Tornillo fijac. elevalunas - todos los modelos modernos -	161.753	46401657
25	Tornillo Ø 4,5 x 19 (aro Ø 12), fijac. plásticas varias (ver PSA)	161.760	
50	Tornillo Ø 4,2 x 18 (aro Ø 15), fijac. rejilla parabrisas Dobló '09, Fiorino/Qubo '07, Grande Punto, Linea '07, Punto EVO '09, Punto '13	161.860	15532209
50	Tornillo Ø 4,7 x 15 (aro Ø 18), fijac. pasoruada 500 '07->'12, Bravo '10->	161.861	15532409
50	Tornillo Ø 4,7 x 16, fijac. pasoruada 500 '12->, 500 Abarth, Panda '03 y '12->, fij. faro Linea '07->	161.862	15690808
50	Tornillo fijac. pasoruada y tapizados Alfa Romeo 147, 156, 166, Fiat Bravo/a, Croma '05, Marea, Multipla, Punto '99 y '03, Tipo, Tempra, Lancia Lybra, Kappa, Y, Ypsilon	162.710	7630815 15690307

Ø M6 x 22
Cabeza 20 x 20



162.356

Ø M6 x 22



162.528

Ø M6 x 25
arandela Ø 18



161.723

Ø M6 x (10+21)



161.458

Ø M8 x 18
Cabeza 20 x 20



162.357

Ø M8 x 20



161.455

Ø M8 x 16



162.363

Ø M8 x 20



161.705

U.E.	DESCRIPCION	261	Ref. Adaptable
10	Tornillo fijación travesía delantera Fiat Tipo, Tempra, Marea, fijac. guardabarros Bravo/a, Dedra, y parachoques Alfa Romeo 33	161.455	7609062
10	Tornillo fijac. parachoques del. Bravo/a, Marea (monta con 162.893)	161.458	7771629
10	Tornillo fijac. parachoques Bravo/a, Punto, Tipo/Tempra (ver Renault)	161.705	18772114
25	Tornillo Ø 6 x 23 con aro móvil Ø 18, varios usos (ver PSA)	161.723	
25	Tornillo fijac. parachoques Uno, Punto, Ducato (ver Seat)	162.356	7628035
25	Tornillo fijac. parachoques Uno, Regata, Y-10, Thema (ver Seat)	162.357	5940767 7569387
25	Tornillo fijac. parachoques Fiat Cinquecento, Uno, Punto, Bravo/a, Marea, Regata, Cromo, Ducato, Lancia Y-10, Thema, (monta con 162.359) (ver Seat)	162.363	16043324
25	Tornillo fijac. guardabarros delantero Bravo/a, Dobló, Ducato, Punto '99, Lancia Lybra, Y	162.528	10707524 18770424

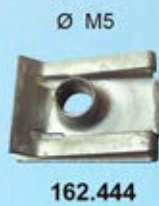

U.E.	DESCRIPCION	261	Ref. Adaptable
50	Clip fijac. pasoruada Alfa Romeo 147, 159, 166, Fiat Bravo/a, Punto '99 y '03, Lancia Lybra, Kappa, Y	161.411	14368974
50	Clip fijac. montante Alfa Romeo 146, 155, 166, Fiat Bravo/a, Dobló, Ducato, Marea, Palio, Stilo, Tipo, Lancia Lybra, Y	161.464	60808479 7740882
50	Clip fijac. panel puerta Fiat Stilo, Lancia Y, fijac. parachoques Barchetta, Palio, fijac. tapizados Fiat Dobló, Multipla y fijac. faros antiniebla Alfa Romeo 156, 159	161.488	7729424
50	Clip fijac. faro antiniebla Panda 2003, panel puerta Lancia Lybra	161.701	14188971
25	Tuerca fijac. parachoques Fiat Cinquecento, Croma, Punto, Regata, Uno, Lancia Y-10 y Thema (monta con 162.363) (ver Seat)	162.359	5967727 7508973
25	Boca fijac. guardabarros Alfa Romeo 147, 156, 159, Fiat Bravo/a, Cinquecento, Dobló, Ducato, Marea, Seicento, Stilo, Palio, Punto, Punto '03, Grande Punto '05, Lancia Lybra, Y-10, Y (ver PSA)	162.439	15624411
50	Clip fijac. guardabarros Fiat Bravo (ver PSA, Renault, VAG)	162.442	60811807
50	Clip fijac. faro Fiat Bravo/a, Marea (ver Renault)	162.444	46473571
25	Boca fijac. guardabarros Fiat Bravo/a, Marea, Punto	162.525	7678439 7781538
25	Boca fijac. guardabarros Alfa Romeo 145, 146, 147, 156, Fiat Bravo/a, Croma'05, Marea, Punto, Punto '03, Strada, Uno, Lancia Y-10, Y	162.527	7677561
10	Fijac. guardabarros Alfa Romeo 145 / 146 / 155, Fiat Cinquecento, Seicento, Croma, Tipo, Tempra, Lancia Delta, Nuevo Delta, Dedra	162.697	7622939

Ø exterior 10
tornillo Ø 4



161.759

Tornillo Ø 4,2



161.459



161.797



161.485



161.448



161.751

Ø 2,4 x 5



162.362

Ø 4,8 x 10

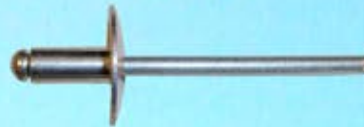

161.864

Ø 4,8 x 13



161.863

Ø 4,8 x 17



161.814

Ø 4,8 x 21



161.796

U.E.	DESCRIPCION	261	Ref. Adaptable
50	Fijac. manecilla elevalunas Fiat Punto '97 (ver Seat)	161.448	4138439
25	Tuerca fij. revestimientos interiores Alfa Romeo 147, 159, GT, Fiat Bravo/a, Marea, Punto '99 y '03, Stilo, Lancia Dedra y Nuevo Delta (ver VAG)	161.459	82488491
25	Fijac. moldura pasoruada Bravo '07, Dobló, Palio, Siena, Stilo, Strada	161.485	46428157
25	Fijac. parachoques Alfa Romeo 147, 156, 159, Fiat Siena, Strada, y fijac. tapizados Fiat Dobló, fijac. rejilla radiador Fiat Cromo'05 y Palio	161.751	46790807
50	Clip fijac. parachoques Alfa Romeo 147, 156, GT	161.759	14228471
25	Remache Ø 4,8 x 21, fijac. parachoques Alfa Romeo 147, 159, Mito, Fiat Bravo/a, Punto '99->'09 (ver Ford)	161.796	14415890
25	Fijac. parachoque delantero Ducato '06-> (ver PSA)	161.797	1355845080
25	Remache Ø 4,8 x 17, fij. parachoques Alfa Romeo Mito, Giulietta, Fiat Dobló '09, Grande Punto '05, Panda '12, Punto EVO '09, Lancia Ypsilon '11	161.814	51756626
25	Remache Ø 4,8 x 13, fijac. parachoques Fiat 500 '07->'12, 500 Abarth '12->	161.863	51798831
50	Remache Ø 4,8 x 10, fijac. protecciones escape 500 '07->'12 y '12->, Bravo '10->, Dobló '09->, Multipla, Panda '03->'11	161.864	46547223
50	Remache Ø 2,4 x 5, varias aplicaciones Cinquecento, Uno, Tipo, Tempra, Ducato, Alfa Romeo (ver Ford, Opel, PSA, Renault, V.A.G.)	162.362	

162.514*

162.404*

162.894

162.893

162.536*

162.403

162.400

* (imagen 1/2 tamaño real)

U.E.	DESCRIPCION	261	Ref. Adaptable
5	Tope parachoques Uno, Croma, Y-10, Thema (ver Seat)	162.400	5981746
10	Tope parachoques Tipo, Tempra, Dedra, Alfa 155 (ver VAG)	162.403	7608126 60805802
-	Tope parachoques Alfa - varios -, Lancia Dedra	162.404	82428097
-	Tope antivibrador parachoques delantero Punto	162.514	7762436 46427367
-	Tope parachoques delantero Cinquecento	162.536	7699248
5	Soporte parachoques delantero Bravo/a, Marea (monta con 161.458)	162.893	7771628
5	Tapón fijac. parachoques delantero y trasero Bravo/a, Marea, Palio	162.894	7788400

261/

164.341 *- Izdo.



164.340 *- Dcho.



164.343 *- Izdo.



164.342 *- Dcho.



164.719 *- Izdo.



164.718 *- Dcho.

* (imagen 1/2 tamaño real)

U.E.	DESCRIPCION	261	Ref. Adaptable
1	Soporte parachoque delantero derecho Fiat Punto EVO '09->, Punto '13->	164.340	51852309
1	Soporte parachoque delantero izquierdo Fiat Punto EVO '09->, Punto '13->	164.341	51858852
1	Soporte parachoque delantero derecho Fiat Panda '12->	164.342	51880502
1	Soporte parachoque delantero izquierdo Fiat Panda '12->	164.343	51880501
1	Soporte parachoque trasero derecho Fiat Panda '12->	164.718	51880537
1	Soporte parachoque trasero izquierdo Fiat Panda '12->	164.719	51880539



163.947 *- Izdo.



163.946 *- Dcho.



164.741 *- Izdo.



164.740 *- Dcho.

* (imagen 1/2 tamaño real)

U.E.	DESCRIPCION	261	Ref. Adaptable
1	Soporte parachoque delantero derecho Fiat 500 '07->'12	163.946	51786776
1	Soporte parachoque delantero izquierdo Fiat 500 '07->'12	163.947	51786777
1	Soporte parachoque trasero derecho Fiat 500 '07->'12	164.740	52046540 51797764
1	Soporte parachoque trasero izquierdo Fiat 500 '07->'12	164.741	52046539 51797765

261/

164.717 *- Izdo.



164.716 *- Dcho.



164.743 *- Izdo.



164.742 *- Dcho.



164.769 *- Izdo.



164.768 *- Dcho.

* (imagen NO a tamaño real)

U.E.	DESCRIPCION	261	Ref. Adaptable
1	Soporte parachoque delantero derecho Fiat 500 L '12->	164.716	51988464
1	Soporte parachoque delantero izquierdo Fiat 500 L '12->	164.717	51988465
1	Soporte parachoque trasero derecho Fiat 500 L '12->	164.742	51891326
1	Soporte parachoque trasero izquierdo Fiat 500 L '12->	164.743	51891328
1	Soporte parachoque delantero derecho Alfa Romeo Mito '08->	164.768	50510294
1	Soporte parachoque delantero izquierdo Alfa Romeo Mito '08->	164.769	50510295

261/



171.434*



173.080*



164.692* - Dcho.
164.693* - Izdo.

* (imagen 1/2 tamaño real)



162.720



162.535



162.250



162.251



162.247



162.248



162.533



164.434

U.E.	DESCRIPCION	261	Ref. Adaptable
50	Fijac. faro Fiat Regata (ver Seat)	162.247	4241451
50	Fijac. faro Fiat Regata, Lancia Y-10 (ver Seat)	162.248	7544349
25	Fijac. faro Fiat Tipo, Tempira	162.250	15681000
25	Fijac. faro Fiat Tipo	162.251	14341000
5	Regulador faro Fiat Uno	162.252	5952101
25	Fijac. faro Fiat Cinquecento, Alfa Romeo - varios - (ver Seat)	162.533	7656214
10	Fijac. faro Bravo/a, Cinquecento, Dobló, Marea, Seicento	162.535	7703577
10	Fijac. lateral faro Bravo/a, Ducato, Ducato 2002, Marea (ver VAG)	162.720	46440164 46461781
25	Fijac. faro delantero Panda '03->'11	164.434	71748660
1	Kit reparación faro derecho Fiat 500 '07 y '12->	164.692	51816681
1	Kit reparación faro izquierdo Fiat 500 '07 y '12->	164.693	51816682
1	Regulador eléctrico faro Fiat Scudo (ver PSA)	171.434	9632162280
1	Regulador eléctrico faro Iveco Daily (ver Ford, Smart, VAG)	173.080	42536208

261/



164.700* - Dcho.
164.701* - Izdo.



164.680* - Dcho.
164.681* - Izdo.



163.118* - Dcho.
163.119* - Izdo.



163.402* - Dcho.
163.403* - Izdo.



163.400* - Dcho.
163.401* - Izdo.



163.606* - Dcho.
163.607* - Izdo.

* (imagen 1/2 tamaño real)

U.E.	DESCRIPCION	261	Ref. Adaptable
1	Kit reparación faro derecho Fiat Punto '99->'03	163.118	
1	Kit reparación faro izquierdo Fiat Punto '99->'03	163.119	
1	Kit reparación faro derecho Fiat Panda '03->'12	163.400	71738355
1	Kit reparación faro izquierdo Fiat Panda '03->'12	163.401	71738749
1	Kit reparación faro derecho Fiat Idea '03->'12, Multipla, Lancia Musa	163.402	51749550
1	Kit reparación faro izquierdo Fiat Idea '03->'12, Multipla, Lancia Musa	163.403	51749551
1	Kit reparación faro derecho Fiat Punto '03->	163.606	
1	Kit reparación faro izquierdo Fiat Punto '03->	163.607	
1	Kit reparación faro derecho Fiat Stilo '01->'09	164.680	46838535
1	Kit reparación faro izquierdo Fiat Stilo '01->'09	164.681	46838536
1	Kit reparación faro derecho Fiat Grande Punto '05->'11	164.700	51774058
1	Kit reparación faro izquierdo Alfa Grande Punto '05->'11	164.701	51774059

261/



163.025



163.053



163.609



162.900



162.901



162.316



162.886



163.492



162.897



164.647



164.482*- Dcho.
164.483*- Izdo.



164.486 - Dcho.
164.487 - Izdo.

* (imagen 1/2 tamaño real)

U.E.	DESCRIPCION	261	Ref. Adaptable
10	Fijac. cristal lateral Alfa Romeo 147, Fiat Dobló, Punto, Punto '99, Punto '03, Palio, Multipla, Uno, Lancia Lybra, Y, Y-10	162.316	5994095 7775575
10	Fijac. elevallunas Punto	162.886	
10	Fijac. cristal posterior a montante puerta y luneta Alfa Romeo 147, Fiat Bravo/a, Multipla, Lancia Y	162.897	46436251
10	Fijac. cristal lateral Bravo/a, Marea	162.900	7769767
10	Fijac. cristal lateral Ducato, Tipo, Tempra (ver P.S.A.)	162.901	7608099
10	Fijac. cristal lateral Alfa Romeo 156, 159, Fiat Grande Punto '05	163.025	60655007 60664928
10	Fijac. cristal lateral Alfa Romeo 147, Fiat Dobló, Punto 2003	163.053	46776048
10	Fijac. cristal lateral Punto, Nuova Punto, Lancia Y	163.492	4373915 + 46796761
10	Fijac. cristal lateral Ducato'94, Ducato Restyling, Grande Punto '05->	163.609	7798609
1	Soporte cristal elevallunas trasero derecho Alfa Romeo 159	164.482	
1	Soporte cristal elevallunas trasero izquierdo Alfa Romeo 159	164.483	
1	Soporte cristal elevallunas derecho Scudo '07-> (ver PSA)	164.486	
1	Soporte cristal elevallunas izquierdo Scudo '07-> (ver PSA)	164.487	
10	Fijac. cristal lateral Dobló '09->, Fiorino '07->, Linea '07->. Qubo '07->	164.647	1360834080

261/



163.552*- Dcho.
163.553*- Izdo.



164.012*- Dcho.
164.013*- Izdo.



164.010*- Dcho.
164.011*- Izdo.



164.008*- Dcho.
164.009*- Izdo.



164.362*- Dcho.
164.363*- Izdo.



164.488*- Dcho.
164.489*- Izdo.



163.500*



164.484 - Dcho.
164.485 - Izdo.

* (imagen 1/2 tamaño real)

U.E.	DESCRIPCION	261	Ref. Adaptable
1	Soporte cristal lateral Marea '99->'04, Panda '03->	163.500	46474945
1	Soporte cristal elevalunas derecho Fiat Dobló '00->'09	163.552	
1	Soporte cristal elevalunas izquierdo Fiat Dobló '00->'09	163.553	
1	Soporte cristal elevalunas delantero derecho Ducato '94->'06 (ver Opel, PSA, Renault)	164.008	
1	Soporte cristal elevalunas delantero izquierdo Ducato '94->'06 (ver Opel, PSA, Renault)	164.009	
1	Soporte cristal elevalunas delantero derecho Ducato '06->, Linea, Palio (ver PSA)	164.010	
1	Soporte cristal elevalunas delantero derecho Ducato '06->, Linea, Palio (ver PSA)	164.011	
1	Soporte cristal elevalunas trasero derecho Palio, Punto '00->'09	164.012	
1	Soporte cristal elevalunas trasero izquierdo Palio, Punto '00->'09	164.013	
1	Soporte cristal elevalunas derecho Fiat Bravo '07->, Dobló '10->	164.362	
1	Soporte cristal elevalunas izquierdo Fiat Bravo '07->, Dobló '10->	164.363	
1	Soporte cristal elevalunas derecho Grande Punto '05->, Fiorino '07-> (ver PSA)	164.484	
1	Soporte cristal elevalunas izquierdo Grande Punto '05->, Fiorino '07 (ver PSA)	164.485	
1	Soporte cristal elevalunas derecho Iveco Daily '00->	164.488	
1	Soporte cristal elevalunas izquierdo Iveco Daily '00->	164.489	



162.427



162.870



162.872



162.873



162.516



162.515



162.273



162.898



162.270



162.899



163.220



161.408



162.406



164.381

U.E.	DESCRIPCION	261	Ref. Adaptable
5	Tope (goma) capó Uno	161.408	7635984
10	Fijac. varilla capó Alfa R. 145/146, Fiat Bravo/a, Croma '05, Dobló, Ducato, Marea, Tipo, Tempra	162.270	7622907
10	Fijac. varilla capó Fiat Uno, Regata (ver Seat)	162.273	4392447
5	Tope (goma) capó y portón Alfa Romeo 155, Fiat Cinquecento, Tipo, Tempra, Croma, Ducato, Lancia Dedra, Nuevo Delta, Kappa	162.406	7603637
25	Fijac. varilla cerradura Tipo, Tempra, Ducato, Y-10 (ver Seat)	162.427	14578082
10	Fijac. varilla capó Fiat Punto -todos-, Lancia Y, Ypsilon	162.515	7739088
10	Fijac. varilla capó Fiat Punto, Punto '99 y '03, Lancia Dedra, Nuevo Delta, Kappa	162.516	7792009 82457328
25	Fijac. varilla cerradura puerta Ducato, Cinquecento, Croma, Regata, Uno	162.870	14578180
25	Fijac. varilla ceradura puerta Tipo, Tempra, Ducato, A.Romeo - varios -	162.872	7608012
25	Fijac. varilla cerradura puerta A.Romeo 147, 156, Punto '99, Multipla	162.873	82377992
10	Fijac. varilla capó Fiat Bravo/a, Marea, Punto, Punto '99 y '03, Palio, Croma, Dobló, Ducato, Lancia Y, Nuevo Delta, Dedra	162.898	60607024 504001603 82467481
10	Fijac. varilla capó Fiat Bravo/a, Marea	162.899	46425772
10	Fijac. varilla capó Fiat Panda 2003	163.220	51704854
5	Tope (goma) capó y portón Uno, Y-10 (ver PSA, Renault)	164.381	4276430



U.E.	DESCRIPCION	261	Ref. Adaptable
10	Fijac. rejilla Alfa Romeo 33, 75, 90	162.351	60528009
50	Fijac. gomas puerta y capó Ducato (ver PSA)	162.880	9605146380
25	Tapón para toma de aire exterior Alfa Romeo 147, Bravo/a, Marea	162.911	46424310
10	Fijac. faros delanteros Fiat Dobló, Alfa Romeo 156, fijac. rejilla radiador Fiat Croma, Lancia Delta, Alfa 33 y fijac. tapizados interiores Barchetta, Cinquecento, Marea, Marengo	163.095	82435506 60517025
10	Fijac. tapizados interiores y rejilla radiador Alfa Romeo 145, 146, 156 y Fiat Ducato III '06-> fijac. parachoques delantero Alfa Romeo 156 (ver PSA)	163.096	60584337
10	Fijación parrilla radiador Fiat 500 '07->, Croma '05->, fijación spoiler bajo puerta Alfa Romeo 156, 164 y fijac. tapizados interiores Barchetta, Alfa Romeo 145, 146, 147, 156, 164, 166	163.097	60507674
25	Fijac. pasoruada Ducato - todos -, y fijac. tapizados interiores y protecciones Fiat Bravo/a, Fiorino, Panda '03, Talento, Uno (ver PSA)	163.493	4343799
25	Fijac.insonorizantes capó Alfa Romeo 159, Brera, Spider'06, Fiat Bravo '07, Croma '05, Ducato '06, Grande Punto'05, Linea, Palio, Siena, Strada (ver PSA)	163.495	46804433
50	Fijac. pasoruada Fiat 500 '07-> (ver Dacia, Ford, Mercedes, Smart)	163.830	50504884
25	Fijac. pasoruada Alfa Romeo 159, Brera, Mito, Fiat Croma '05, Dobló '00->'09, Ducato '06, Grande Punto, Linea, Punto EVO, Qubo	163.970	60502080
25	Fijación parrilla radiador Fiat 500, Dobló, Idea, Palio, Ducato '06->, Lancia Musa '07->	164.435	46432008
50	Fijac. gomas puerta Fiat Bravo '07, fijac. junta portón trasero Fiat Ducato '11->	164.437	71748958
1	Botón abridor portón Ducato '06->'11 (ver PSA)	164.522	735426396



U.E.	DESCRIPCION	261	Ref. Adaptable
10	Base posicionador parabrisas Alfa Romeo 147, Mito, Fiat 500 '07, Bravo/a, Marea, Panda 2004, Punto '99 y '03 y Evo, Grande Punto '05, Lancia Ypsilon (Eurocode 3359ASCH6B) (ver PSA)	162.965	46541864
25	Fijac. rejilla parabrisas "torpedo" Iveco Daily '14-> (Eurocode 3771ASCVB) (ver Ford)	163.013	500326189
50	Remache fijac. rejilla parabrisas "torpedo" Fiat 500 '07->, Croma '05->, Panda '12->	163.140	51761163
10	Fijac. rejilla parabrisas "torpedo" Sedici '06-> (Eurocode 3363ASCR) (ver Suzuki, Toyota)	163.248	71743321
50	Remache fijac. rejilla parabrisas "torpedo" Alfa Romeo Giulietta	163.344	51834606
10	Base soporte parabrisas Iveco Daily (Eurocode 7247ASCV) (ver Renault)	163.425	504085696
25	Fijac. rejilla parabrisas "torpedo" Grande Punto '05->, Punto '12->	163.608	71747674
50	Fijac. rejilla parabrisas "torpedo" Fiat Stilo '01-> (Eurocode 3355ASCHB)	163.837	14591987
10	Fijac. moldura inferior parabrisas Sedici '06-> (Eurocode 6291ASCV) (ver Opel, Suzuki)	163.852	51819230
10	Fijac. rejilla parabrisas "torpedo" Talento '16-> (Eurocode 6340ASCVS) (ver Opel, PSA, Renault)	163.882	
10	Fijac. rejilla parabrisas "torpedo" Alfa Romeo 159, Brera, Fiat Ducato III '06 (ver PSA)	163.920	60697869
25	Fijac. rejilla parabrisas "torpedo" Fiat Sedici '06->	164.153	71741887
25	Fijac. soporte rejilla parabrisas "torpedo" Ducato III '06-> (ver PSA)	164.294	1355837080
10	Fijac. moldura lateral parabrisas Talento '16-> (Eurocode 6340ASCVS6B) (ver Opel, Renault)	164.442	
50	Fijac. rejilla parabrisas "torpedo" Ducato III '06-> (Eurocode 6552ASCV) (ver PSA)	164.462	71737918
50	Fijac. moldura parabrisas Iveco Daily '14-> (Eurocode 3771ASCVS)	164.463	5801720444
25	Fijac. rejilla parabrisas "torpedo" Fiat 500 '07->'12 y '12->, 500 Abarth (Eurocode 3367ASCTB)	164.665	71752832



162.992



162.993



163.098



164.462



164.285

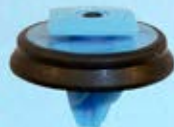

164.370



163.052



163.612



162.263



162.691



162.679



162.680



162.964



162.475



162.392



162.944



163.394



163.011

U.E.	DESCRIPCION	261	Ref. Adaptable
25	Fijac. moldura techo Fiat Cinquecento, Palio, Siena, Uno, Ducato, Fiorino, Lancia Thema	162.263	5998258 7686500
25	Fijac. moldura bajo puerta Fiat Uno Restyling 2ª serie	162.392	7678808
25	Fijac. junta estanqueidad puerta Fiat Palio, Siena, Strada (ver Renault)	162.475	7078732
25	Fijac. molduras Lancia Dedra, Thema (ver Seat)	162.679	4294167
25	Fijac. moldura Fiat Scudo, Ulisse, Lancia Delta moderno, Zeta (ver PSA)	162.680	7778275
25	Fijac. moldura parachoques Fiat Tipo, Tempra	162.691	7613917
10	Fijac. moldura lateral Fiat Multipla (ver BMW, Opel)	162.944	71717421
10	Fijac. molduras puerta Fiat Ulisse (ver PSA)	162.964	9620669780
50	Fijac. moldura Iveco Daily (ver Opel, Renault)	162.992	500339745
50	Fijac. moldura Iveco Daily (ver Opel, Renault)	162.993	500326896
10	Fijac. molduras Iveco Daily	163.011	500327002
25	Fijac. moldura lateral Fiat Ducato 2001-> (ver PSA)	163.052	71728806
25	Fijac. moldura lateral Fiat Dobló	163.098	71728805
50	Boca fijac. moldura lateral Fiat Multipla, Lancia Y 2000 (ver BMW, VAG)	163.394	
25	Fijac. moldura lateral Iveco Daily '06->	163.612	504101707
25	Fijac. moldura aletas y talonera puerta Sedici '06-> (ver Suzuki)	164.285	71741889
25	Fijac. moldura lateral puerta y aletas Panda '12->	164.370	735537083
50	Fijac. moldura lateral puerta Multipla, Stilo (ver PSA)	164.462	71719954



162.229



162.598



162.227



163.093



164.404



162.510



162.399



162.398



162.976



162.714



162.232



162.699



162.465



163.094



162.895



163.499

U.E.	DESCRIPCION	261	Ref. Adaptable
50	Fijac. panel puerta Alfa Romeo - varios -, Fiat Dobló, Marea, Uno, Lancia Y-10	162.227	14188282 92511089 46306526
100	Fijac. panel puerta Uno, Regata, Alfa 33 (ver PSA, Renault)	162.229	14188380
50	Fijac. panel puerta Y-10	162.232	7570122
50	Fijac. revestimientos interiores Tipo, Tempra	162.398	7658893
50	Fijac. panel puerta y revestimientos interiores Fiat Multipla, Panda '03, Punto '93, Seicento, Lancia Kappa, Lybra, Y	162.399	46410400 60600860
50	Fijac. panel puerta Iveco (ver Ford, PSA, Renault)	162.465	14116890
50	Fijac. panel puerta Alfa Romeo 145, 146, 156, 166, GT, Fiat Bravo/a, Cromo, Dobló, Marea, Panda'03, Punto -todos-, Tipo/Tempra, Lancia Nuevo Delta, Y, Ypsilon	162.510	7733801
50	Fijac. panel puerta Regata (ver Seat)	162.598	4399987
10	Fijac. panel puerta Bravo/a, Marea	162.699	7769778
50	Fijac. panel puerta Tipo, Tempra, Uno, Alfa 33, Lancia Y-10, Delta (ver PSA)	162.714	14191280 82377183
25	Fijac. toma aire Fiat Bravo/a, Marea, Multipla, Lancia Lybra, fijac. tapiz. interiores traseros Alfa Romeo 159	162.895	46459200
50	Fijac. panel puerta Fiat Punto '99 y '03, fijac. panel maletero Fiat Stilo '01 (monta con 162.977)	162.976	46776091
50	Fijac. spoiler bajo puerta Fiat Punto '99 y '03, y Punto EVO, Stilo '01, fij. panel puerta Fiat Cromo, Lancia Thema	163.093	14186880 46786189
25	Fijac. tapizados interiores Alfa Romeo 156, Fiat Punto '99-'03, Lancia Thesis	163.094	60660554
25	Fijac. tapizados portón trasero Fiat Cromo '05, Panda '03	163.499	51708640
10	Fijac. panel puerta Fiat Freemont (ver Chrysler)	164.404	68045836AA



162.229



162.598



162.227



163.093



164.404



162.510



162.399



162.398



162.976



162.714



162.232



162.699



162.465



163.094



162.895



163.499

U.E.	DESCRIPCION	261	Ref. Adaptable
50	Fijac. panel puerta Alfa Romeo - varios -, Fiat Dobló, Marea, Uno, Lancia Y-10	162.227	14188282 92511089 46306526
100	Fijac. panel puerta Uno, Regata, Alfa 33 (ver PSA, Renault)	162.229	14188380
50	Fijac. panel puerta Y-10	162.232	7570122
50	Fijac. revestimientos interiores Tipo, Tempra	162.398	7658893
50	Fijac. panel puerta y revestimientos interiores Fiat Multipla, Panda '03, Punto '93, Seicento, Lancia Kappa, Lybra, Y	162.399	46410400 60600860
50	Fijac. panel puerta Iveco (ver Ford, PSA, Renault)	162.465	14116890
50	Fijac. panel puerta Alfa Romeo 145, 146, 156, 166, GT, Fiat Bravo/a, Cromo, Dobló, Marea, Panda'03, Punto -todos-, Tipo/Tempra, Lancia Nuevo Delta, Y, Ypsilon	162.510	7733801
50	Fijac. panel puerta Regata (ver Seat)	162.598	4399987
10	Fijac. panel puerta Bravo/a, Marea	162.699	7769778
50	Fijac. panel puerta Tipo, Tempra, Uno, Alfa 33, Lancia Y-10, Delta (ver PSA)	162.714	14191280 82377183
25	Fijac. toma aire Fiat Bravo/a, Marea, Multipla, Lancia Lybra, fijac. tapiz. interiores traseros Alfa Romeo 159	162.895	46459200
50	Fijac. panel puerta Fiat Punto '99 y '03, fijac. panel maletero Fiat Stilo '01 (monta con 162.977)	162.976	46776091
50	Fijac. spoiler bajo puerta Fiat Punto '99 y '03, y Punto EVO, Stilo '01, fij. panel puerta Fiat Cromo, Lancia Thema	163.093	14186880 46786189
25	Fijac. tapizados interiores Alfa Romeo 156, Fiat Punto '99-'03, Lancia Thesis	163.094	60660554
25	Fijac. tapizados portón trasero Fiat Cromo '05, Panda '03	163.499	51708640
10	Fijac. panel puerta Fiat Freemont (ver Chrysler)	164.404	68045836AA



U.E.	DESCRIPCION	261	Ref. Adaptable
50	Fijac. panel puerta Fiat Uno	162.228	7538675
100	Fijac. panel puerta Fiat Uno 1ª serie, Regata, Ducato (ver Seat)	162.378	14187880
50	Fijac. panel puerta Alfa Romeo 145/146, Fiat Ducato '94, Uno, Y (ver PSA)	162.379	14191180
50	Fijac. panel puerta Fiat Tipo, Tempra 1ª serie, Cinquecento	162.530	7603823 + 7603825
25	Fijac. tapizados interiores -varios modelos- (ver Ford)	163.013	500326189
25	Fijac. panel puerta Fiat Ulisse (ver PSA, Renault)	163.083	9654280780
25	Fijac. revestimientos interiores Alfa Romeo 147, Fiat Idea, Punto EVO	163.221	46829200
25	Fijac. panel puerta y revestimientos interiores Fiat Grande Punto '05->	163.397	
25	Fijac. parachoques Alfa Romeo Giulietta, Fiat Grande Punto '05->, moldura lateral Fiat Panda '03->, Dobló '09->	163.399	46835626 71738386
50	Fijac. panel puerta lateral deslizante Fiat Scudo III (ver Dacia, PSA, Renault)	163.453	
25	Fijac. rejilla lavaparabrisas "torpedo" Grande Punto '05, Punto '12->, fijac. tapizados portón trasero Cromia'05	163.608	71747674
50	Fijac. junta puerta corredera Dobló '09->, fij. tapizados interiores Fiat Dobló '00->	163.965	51831913 46837943
50	Fijac. tapizados interiores Fiat Grande Punto	163.967	71748293
25	Fijac. panel puerta y tapizados Fiat Qubo	163.968	735500166
25	Fijac. panel puerta Fiat 500X '14->	164.622	51987227
25	Fijac. panel puerta Fiat Tipo '15-> (ver Chrysler/Jeep)	164.849	52034852
25	Fijac. tapizados interiores Fiat 500X '14-> (ver Chrysler/Jeep)	164.852	52078320
25	Fijac. tapizados portón Fiat Tipo '15->	164.853	52055147



U.E.	DESCRIPCION	261	Ref. Adaptable
50	Fijac. guardabarros, guarnición puerta y tapizados Alfa Romeo 145, 146, 147, 155, 156, fijac. guarnición puerta y tapizados Fiat Bravo/a, Croma, Dobló, Ducato, Marea, Multipla, Palio, Punto, Stilo, Tipo, Tempra, Uno, Lancia Y	162.369	76778650
100	Fijac. tapizados Fiat Punto '99->'03, Palio, Siena, Uno, Fiorino, Lancia Y-10, Thema (ver Seat)	162.493	14592587
100	Botón fijac. revestimientos interiores Cinquecento, fijac. aislante capó Tipo, Tempra (ver PSA)	162.660	82412036
50	Botón fijac. aislante capó Fiat Cinquecento, Uno, Punto, Bravo/a, Marea, Croma, Lancia Y-10, y fijac. panel puerta Alfa Romeo Brera	162.706	5961759 7560860
50	Botón fijac. revestimiento capó Alfa Romeo 155, Fiat Bravo/a, Uno, Tipo, Lancia Dedra, Delta	162.815	60606575 5757139
50	Fijac. aislante capó Alfa 147, 156, 159, Brera, Fiat Bravo/a, Dobló, Marea, Punto'99 y '03, Palio, Lancia Kappa, Lybra, y fijac. revestimientos portón Punto'99	162.908	735266957
50	Fijac. radiador Alfa 156, guarnición capó Punto, Bravo/a, Marea, Punto	162.909	7768047
25	Fijac. pasoruada Fiat Stilo	163.099	46842097
25	Fijación panel puerta Fiat Dobló	163.217	735366395
50	Fijación pasoruada Grande Punto, fij. toma de aire Bravo '07->, fij. tapizados interiores Punto	163.945	718115080
25	Fij. tapizados y protecciones interiores Alfa R. Mito, Fiat Idea, Punto '99 y '03, Lancia Musa, Ypsilon	163.969	735290437
50	Fijac. cubierta capó Alfa Romeo Mito, Fiat Dobló '09->, Fiorino, Grande Punto '05->, Panda '12->, Punto EVO '09->, Qubo	164.204	4380742
25	Fijac. soporte rejilla parabrisas "torpedo" Ducato '06-> (ver PSA)	164.294	1355837080
25	Fijac. insonorizante capó Fiat Freemont (ver Chrysler)	164.432	04878883AA
25	Fijac. pasoruada Fiat 500X '14->	164.857	51822443



U.E.	DESCRIPCION	261	Ref. Adaptable
50	Botón fijac. revestimientos interiores Alfa Romeo 33/164	162.354	60503610
50	Botón fijac. antivibrador parachoques delantero Fiat Punto y fijac. tapiz. interiores Alfa Romeo 156, Fiat Ducato, Palio, Siena (ver PSA)	162.512	1301788650 1301788800 1301019650
25	Fijac. revestimientos interiores Iveco Daily, Lancia Lybra	163.009	504010315
25	Fijac.pasorueda y revestimientos interiores Alfa Romeo 159, Brera, Fiat Bravo/a, Idea, Punto'99, Punto'03, Stilo, Lancia Kappa, Lybra	163.216	14565987
50	Fijac. tapizados Alfa Romeo 145, 146, 147, 155, 156, 166, Brera, GTV, Fiat Bravo/a, Ducato '02, Marea, Tipo, Tempra, Lancia - varios -	163.494	14593487
50	Fijación tapizados interiores Fiat Dobló	163.497	735293986
50	Fijac. rejilla parabrisas "torpedo" Fiat Stilo '01->	163.837	14591987
25	Fijación tapizados interiores Alfa Romeo Mito, Fiat Dobló, Qubo	163.964	735493588
25	Fijac. parachoques y tapizados interiores Fiat Ducato '06, Palio, Siena, Lancia Kappa	163.971	14589887
25	Fijac. tapizados interiores Fiat Dobló '00->'09, Ducato '06	163.972	735430175
50	Fij. tapizados maletero Fiat 500, Ducato, Grande Punto '05->, Panda '03 y '12->, Punto EVO '09-> (ver Ford, PSA)	164.059	735398155
50	Fijac. tapizados interiores Alfa Giulietta, Fiat Bravo '07, Dobló, Ducato '06, Palio, Siena, Stilo	164.407	14589987

2617

6 x 6
Tornillo Ø 3



162.326

6 x 7
Tornillo Ø 3,5



162.245

7 x 7
Tornillo Ø 3



162.238

7 x 7
Tornillo Ø 3,5



162.240

7 x 7
Tornillo Ø 4,2



162.244

7 x 7
Tornillo Ø 4,2



163.611

8 x 8
Tornillo Ø 4,8



162.966

8 x 8
Tornillo Ø 4,8



162.887

Ø 8,5
Tornillo Ø 3,5



162.264

8 x 8
Tornillo Ø 3,5



162.242

8 x 8
Tornillo Ø 4,5



162.534

8 x 8,5
Tornillo Ø 4,2



164.079

10 x 10
Tornillo Ø 4,8



162.928

10 x 10
Tornillo Ø 5,5



162.718

10 x 10
Tornillo Ø 4,2



162.545

10 x 10
Tornillo Ø 4,8



162.243

U.E.	DESCRIPCION	261	Ref. Adaptable
100	Taco fijac. revestimientos interiores Cinquecento, Uno, Bravo/a, Marea, Cromo, Tipo, Tempra, Regata, Ducato, Y-10, varios usos Punto, Alfa R. - varios - (ver Ford, Mercedes, Renault, Seat)	162.238	14201980 17894580
100	Taco fijac. rejilla Fiat Uno, Alfa 145/146, matrícula Fiat Dobló (ver Seat)	162.240	14211580
25	Taco fijac. revestimientos interiores Fiat Punto, Cromo (ver Seat)	162.242	14202782
25	Taco fijac. revestim. interiores Fiat Ducato, Uno, Lancia Y-10, Y (ver Seat)	162.243	14202985
100	Taco fijac. - varios usos - Fiat Punto, Bravo/a, Marea, Tipo, Tempra, Ducato, Lancia Y-10, Alfa R. (ver PSA, VAG)	162.244	83468353 14115960
25	Fijac. pilotos posteriores Fiat Tipo, Tempra (sin junta)	162.245	
50	Boca fijación siglas Fiat Cinquecento, Uno, Regata, Duna, Fiorino	162.264	4358789
100	Taco fijac. revestimientos interiores Fiat Cinquecento, Seicento, Punto, Uno, Tipo, Tempra, Regata, Ducato, Alfa Romeo - varios - (ver Seat, VAG)	162.326	14215480 82468243
50	Taco fijac. revestimientos interiores y pasoruada Fiat Bravo/a, Cinquecento, Cromo, Marea, Regata, Seicento, Uno, Lancia Y-10, Y (ver Seat)	162.534	14202383
50	Fijac. rejilla Fiat Uno, paneles Fiat Tipo, Tempra, varios usos Alfa Romeo (ver Seat)	162.545	14203680
25	Fijac. pasoruada Fiat Punto, revestim. interiores Fiat Tipo, Tempra (ver Ford)	162.718	14222581
10	Boca panel puerta y revestimientos interiores Alfa Romeo 147, 156, 159, 166, Fiat Bravo/a, Dobló, Ducato, Marea, Multipla, Punto -todos-, Stilo, Lancia Kappa, Lybra, Y, Ypsilon (ver PSA)	162.887	46408953 46748771
25	Taco fijac. pasoruadas Fiat, Lancia - varios - (ver Ford)	162.928	14222380 83468453
10	Fijac. panel puerta y revest. interiores Fiat Punto '99 y '03, Lancia Ypsilon	162.966	46558337
25	Taco fijac. matrícula Iveco Daily	163.611	500380712
50	Taco fijac. tapizados interiores Fiat Dobló, Palio, Stilo,	164.079	14215282



U.E.	DESCRIPCION	261	Ref. Adaptable
10	Boca panel puerta Bravo/a, Marea, Tipo, Tempra, Alfa 145, 146 y 155	162.408	7739802
10	Boca panel puerta y revestimientos interiores Fiat Cromia, Multipla, Palio, Punto -todos-, Seicento, Stilo, Strada, Lancia Kappa, Lybra, Y, Ypsilon	162.511	7745194
50	Taco fijac. revestimientos interiores Fiat Cinquecento, Uno, Punto, Bravo/a, Marea, Tipo, Tempra, Alfa 145, 146 y 156 (ver PSA, Renault)	162.523	7543023 7677856
10	Boca panel puerta Fiat Cinquecento, Tipo, Tempra, Ducato, Alfa Romeo 164	162.531	7603825 7636064
25	Fijac. escudo frontal Alfa Romeo 75, 90, 145, 146, 164	162.725	60509945
50	Taco revestim. interiores Bravo/a, Dobló, Punto, Tipo, Alfa (ver VAG)	162.888	7622606
50	Taco fijac. toma aire capó y revestim. interiores Alfa Romeo 147, 156, 159, Mito, Fiat Bravo/a, Dobló, Marea, Punto, Palio, Multipla (ver PSA)	162.892	7754387
25	Taco fijac. revestim. interiores y otros usos Fiat Bravo/a, Cromia, Dobló, Marea, Ducato, Stilo, Tipo, Tempra, Uno, Lancia Dedra, Thema (ver PSA)	162.902	46478225 82422490
10	Boca fij. panel puerta y tapizados Fiat Punto '99 y '03 (monta con 162.976)	162.977	46738532
25	Taco fijac. revestimientos inter. Iveco Daily (ver Dacia, PSA, Opel, Renault)	163.222	500389689
25	Fijac. panel puerta y revestimientos interiores Fiat Grande Punto '05->	163.398	51779614
25	Fijac. revestimientos interiores y tapizados Alfa Romeo 147, 156, GT, Fiat 500 '07, Grande Punto, Punto EVO, Stilo, Lancia Delta	163.966	51721582
25	Fijac. parachoques Fiat Panda '03, Punto '03	164.078	46837757
25	Fijac. panel puerta Fiat 500, Grande Punto '05->	164.163	51806128
25	Fijac. panel puerta Alfa Romeo 147, 156, 159, Fiat 500, Linea '07, Strada '11	164.436	60654116

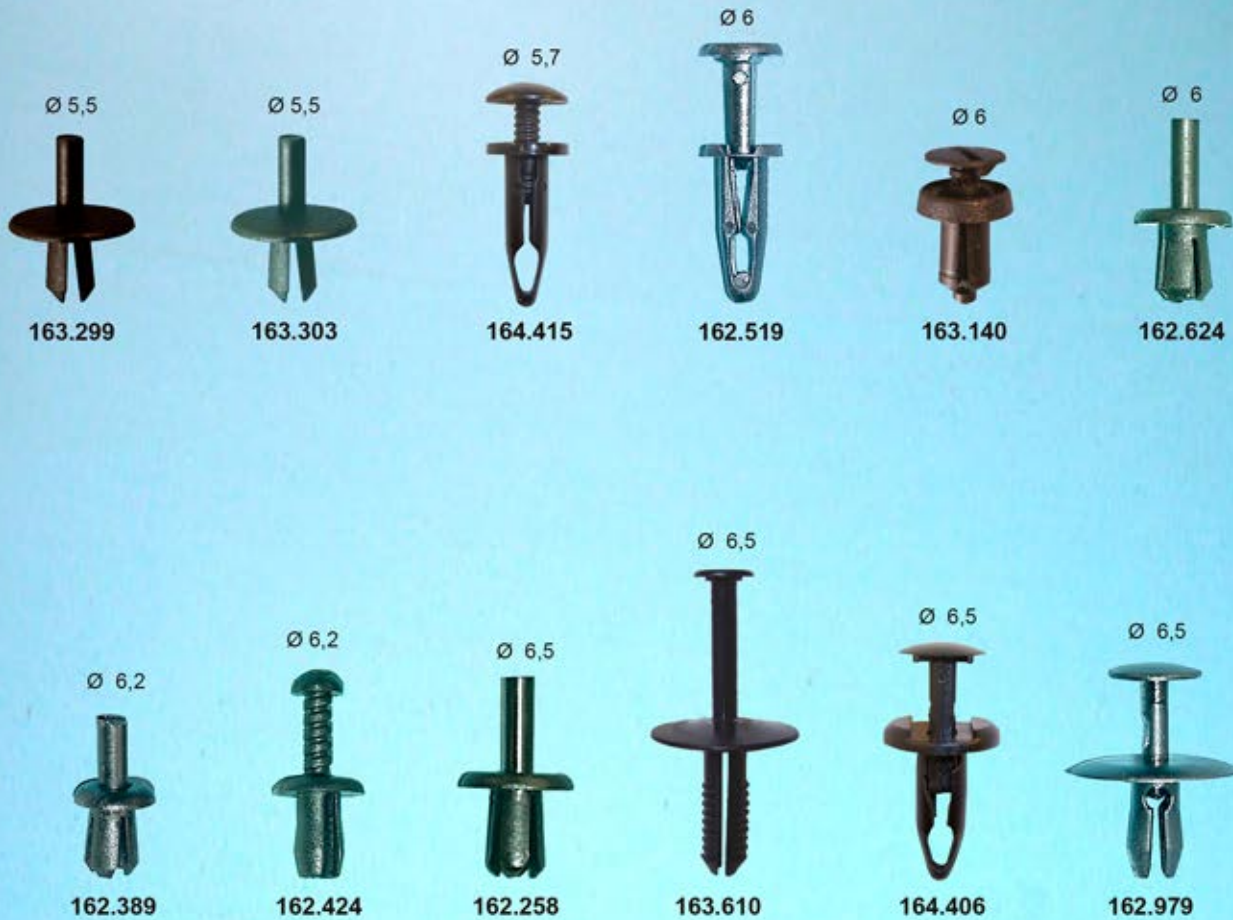

U.E.	DESCRIPCION	261	Ref. Adaptable
50	Remache fijac. revestimientos interiores Alfa Romeo 145, 146, 155, Fiat Uno, Punto, Croma, Tipo, Tempra, Regata, Ducato, Lancia Dedra, Thema	162.258	5988006
100	Remache fij. moldura exterior Panda '03, fijac. revestimientos interiores Cinquecento, Seicento y otros usos Fiat Uno, Croma, Ducato, Alfa Romeo - varios - (ver PSA)	162.389	5962559
50	Fijac. revestimientos interiores Alfa Romeo 145, 146, 155, 166, Fiat Dobló, Tempra, Lancia Delta, Dedra, Kappa, Thesis (ver Mercedes, PSA, Renault, VAG)	162.424	7556533
25	Fijac. motor Uno, Punto, Bravo/a, Marea, Palio, Siena, Tipo, Tempra, fij. guarnición puerta Croma	162.519	7569468
100	Remache fijac. parachoques Fiat Panda '03-> (ver PSA)	162.624	51754057
50	Fijac. guardabarros Fiat Ulysse, Lancia Phedra (ver PSA)	162.979	9621385880
50	Remache fijac. rejilla parabrisas Fiat 500 '07->, Croma '05->, Panda '12-> (ver Dacia, Opel, Renault)	163.140	51761163
50	Remache fijac. revestimientos interiores Fiat Scudo, Ulysse '01, Lancia Phedra (negra) (ver PSA)	163.299	500358569
50	Remache fijac. revestimientos interiores Fiat Scudo, Ulysse '01, Lancia Phedra (gris) (ver PSA)	163.303	9621837480
25	Remache fijac. protector motor y tapizados Croma '05->	163.610	51756677
25	Fijac. moldura aleta y tapizados puerta Fiat Freemont (ver Chrysler)	164.406	06509103AA
25	Fijac. parrilla radiador Fiat Freemont (ver Chrysler)	164.415	06509135AA



U.E.	DESCRIPCION	261	Ref. Adaptable
50	Remache fijac. moldura Alfa Romeo 33	162.260	129421
50	Remache fijac. panel puerta Fiat 500 '07->, fij. revestimientos interiores Cinquecento, Punto, Bravo/a, Marea, Siena, Tipo, Tempra, Ducato, Alfa Romeo 145, 146, 156, GT, Lancia Dedra, Lybra, Thema	162.517	82421028 504056662
50	Remache fijac. talonera puerta, rejilla parabrisas y tapizados interiores Alfa Romeo Giulietta (ver PSA)	163.344	51834606
25	Fijac. pasoruada, parachoque y bajos carrocería Fiat Sedici '06 (ver Honda, Lexus, Suzuki, Toyota)	163.476	71741883
25	Fijac. talonera puerta Fiat Sedici '06-> (ver Chevrolet, Suzuki)	163.814	71741894
25	Fijac. parrilla radiador Ducato '06-> (ver PSA)	163.963	1357450080
10	Fijac. pasoruada y bajos carrocería Alfa Romeo Mito, Fiat Grande Punto, Punto EVO	163.973	51780607
25	Fijac. rejilla parabrisas "torpedo" Fiat Sedici '06-> (ver Suzuki)	164.153	71741887
25	Fijac. moldura puerta Fiat Panda '12->, fijac. tapizados interiores Fiat 500L, Panda '12->	164.371	51897485
25	Fijac. pasoruada Fiat Freemont (ver Chrysler)	164.405	06504521
25	Fijac. parachoques Alfa Romeo Giulietta, Fiat 500 '12->, Dobló '09->, Panda '12->	164.416	51877375
50	Abrazadera (7 x 160) con soporte para fijación cableado (varios modelos)	301.294	82426358

261/

Ø 4,2 x 18



161.851

Ø 4,2 x 20
arandela Ø 17



161.852

Ø 4,8 x 15
arandela Ø 15



161.473

Ø 4,8 x 18
arandela Ø 15



161.474

Ø 5,5 x 19
arandela Ø 18



162.555

Ø 5,5 x 19
arandela Ø 22



161.742

Ø 6,3 x 19
arandela Ø 18



162.556

Ø 6,3 x 19
arandela Ø 22



161.743



161.809



161.810



161.479



161.811



161.822



161.823



161.824

U.E.	DESCRIPCION	261	Ref. Adaptable
50	Tornillo Ø 4,8 x 15 (aro Ø 15), varios usos (ver BMW, Mercedes, Opel, PSA, VAG)	161.473	
50	Tornillo Ø 4,8 x 18 (aro Ø 15), varios usos (ver BMW, Mercedes, Opel, PSA, VAG)	161.474	
25	Fijac. guarnecidos puerta (junta cristal) Ford -varios modelos -	161.479	
50	Tornillo Ø 5,5 x 19 (aro Ø 22), sujeción guardabarros (ver Mercedes, Opel, VAG)	161.742	
50	Tornillo Ø 6,3 x 19 (aro Ø 22), sujeción guardabarros (ver BMW, Mercedes, Opel, VAG)	161.743	
25	Fijación deflector aire Focus '04	161.809	1 357 580 W71115S307
25	Fijación deflector aire Mondeo '00->'07	161.810	1 131 678
25	Fijación parachoque trasero Focus '04->	161.811	1 329 640 3M5114197CB
25	Fijación paneles y revestimientos interiores C-Max '03->, Focus '04->, Kuga '08-> (Eurocode 3546ASCHS)	161.822	1 490 222 1 337 921 W710488S307
25	Fijación revestimientos interiores Focus '04->, Mondeo '00->'07	161.823	1 117 894 W706622S300
25	Fijación panel puerta Fiesta '08, Galaxy '06->, Kuga '08->, Mondeo '07->, S-Max '06->	161.824	1 430 815 W712474S439
10	Fijación parachoque delantero y trasero Kuga '12->	161.851	4 845 761 W704875S439
10	Fijación parachoque delantero y trasero Galaxy '15->, Kuga '12->, S-Max '15->, fijac. bajos carrocería Edge '15->, Mondeo '14->	161.852	5 197 058 W716345S450B
50	Tornillo Ø 5,5 x 19 (aro Ø 18), sujeción guardabarros (ver Opel, VAG)	162.555	2 026 706
50	Tornillo Ø 6,3 x 19 (aro Ø 18), sujeción guardabarros (ver BMW, Mercedes, Opel, VAG)	162.556	1 470 997 1 473 084 2 022 203 6 077 150



164.685



161.461



161.790



161.785



161.854

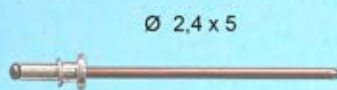

Ø 2,4 x 5

162.362

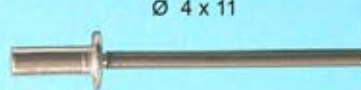

Ø 4 x 11

162.384

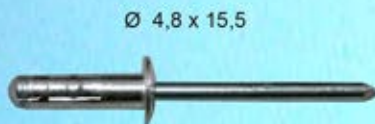

Ø 4,8 x 15,5

161.869



Ø 4,8 x 21

161.796



Ø 5,8 x 20

161.795

U.E.	DESCRIPCION	261	Ref. Adaptable
25	Fijac. protectores cárter y protectores térmicos Escort, Fiesta, Focus, Mondeo, Puma, Sierra, Transit, Transit Connect (ver VAG)	161.461	6 715 468 W700641S301
25	Fijación varios usos -varios modelos- (ver BMW, Mini)	161.785	1 034 869
25	Fijación pasoruada C-Max '03, Fiesta '02 y '08, Focus '04	161.790	1 462 015 W703505S442
25	Remache Ø 5,8 x 20, fijac. parachoques Fiesta '02->'08, Ka '96->'08	161.795	1 071 415 1 229 061
25	Remache Ø 4,8 x 21, fijac. parachoques Fiesta '02->'08, Focus '98->'04, Ka '96->'08 (ver Fiat)	161.796	7 000 412 W702852S300
10	Fijación moldura pilar B y C, Edge '15->, Galaxy '15->, S-Max '15->	161.854	5 175 742 W715150S900
50	Remache Ø 4,8 x 15,5, fijac. parachoque delantero Kuga '13->	161.869	5 170 763 W716070S300
50	Remache Ø 2,4 x 5, varias aplicaciones (ver Fiat, Opel, PSA, Renault V.A.G.)	162.362	6 028 434 E642280S
50	Remache fijac. pasoruada Fiesta '89	162.384	1 647 309
10	Tornillo fij. intermitente delant. a parachoques Focus '98->'05 (monta con 162.963)	164.685	1 077 106 W706160S309

Ø 3,5



161.409

Ø 3,9



161.490

Ø 4,2



161.492

Ø 4,2



161.493

Ø 4,2



161.853

Ø 4,8



161.800

Ø 4,8



161.801

Ø 5,6



161.704

Ø 6,3



161.465

Ø 6,3



161.771

Ø 6,3



161.747

U.E.	DESCRIPCION	261	Ref. Adaptable
50	Clip fijac. varios usos - varios -	161.409	1 474 663 E623300S71
50	Clip fijac. frontal Fiesta, Escort (ver Opel, VAG)	161.465	
50	Clip fijac. varios usos - varios - (ver BMW)	161.490	
50	Clip fijac. varios usos - varios - (ver Mercedes)	161.492	1 716 235
50	Clip fijac. varios usos - varios - (ver BMW, Mercedes)	161.493	
50	Clip fijac. varios usos - varios - (ver BMW, Opel)	161.704	
50	Clip fijac. revestimientos puerta Ford - varios modelos - (ver Mercedes)	161.747	6 314 544
50	Clip fijac. aleta delantera Ford C-Max, Focus '05->, Mondeo '96->'07	161.771	1 084 756 W706066S301
50	Clip fijac. pasoruada Ford C-Max, Focus '05->, Galaxy, Mondeo '00->, S-Max '06	161.800	1 026 679 W702605S300
25	Clip fijac. parachoque y rejilla calandra C-Max '03, Focus '04,	161.801	1 069 428
10	Clip fijac. parachoque delantero y trasero Focus '11->, Kuga '12->, fij. bajos carroceria Mustang '15	161.853	4 764 391 W704823S439



U.E.	DESCRIPCION	261	Ref. Adaptable
100	Clip fijac. varios usos - varios - (ver Mercedes)	161.414	1 503 837
50	Clip fijac. varios usos - varios - (ver Renault)	161.438	
50	Clip fijac. talonera puerta P-306, P-605 (ver PSA, Renault)	161.499	6 103 426 E8224125S81
50	Clip fijac. varios usos - varios - (ver Mercedes, Renault)	161.703	
10	Clip (especial «ovalado») fijac. varios usos - varios -	161.740	6 740 771
25	Tuerca especial redonda varios usos (Ø 6) (ver PSA, Renault)	162.375	
50	Fijac. parachoques - varios modelos - (ver Fiat, PSA, Renault)	162.465	
25	Tuerca con aro móvil, varios usos (ver Dacia, Opel, PSA, Renault, VAG)	162.711	
25	Tuerca con aro móvil, varios usos (ver Opel, PSA, Renault, VAG)	162.712	



U.E.	DESCRIPCION	261	Ref. Adaptable
25	Fijac. rejilla parabrisas ("torpedo") C-Max '03, Fiesta '08, Focus '04, Mondeo '07, S-Max/Galaxy '06	161.811	1 329 640 3M5114197CB
50	Remache rejilla parabrisas ("torpedo") Fiesta, Escort, Sierra, Mondeo, Transit II ('86->'97) (Eurocode 3731ASCBS / 3539ASCHS) (ver VAG)	162.812	6 114 021 E864164S
10	Fijac. rejilla parabrisas ("torpedo") Focus '98->'04 (Eurocode 3556ASCHB)	163.018	1 106 903 W703475S300
10	Fijac. moldura parabrisas Transit IV ('2000->) (Eurocode 3739ASCVS1)	163.021	4 069 906 4 494 055 YC15B03180AB
10	Fijac. moldura parabrisas Transit IV ('2000->) (Eurocode 3739ASCVS)	163.022	4 069 907 4 494 056 YC15B03180BB
25	Tapón parrilla lavaparabr. Escort '97, Mondeo '93 y '97, Transit (Eurocode 3546ASSH/ASCHB1B)	163.023	6 781 550 W701223S300
10	Base soporte parabrisas Fiesta '02->, Galaxy '94->'98, Ka, Mondeo '93->'96 (Eurocode 3554ASCH)	163.133	1 022 510 6 974 009 93BBF030A12AE
10	Fijac. rejilla lavaparabrisas ("torpedo") Mondeo I, Orion. Scorpio (Eurocode 3546ASCHB)	163.613	6 781 549 W701221S300
10	Base soporte parabrisas Focus '98->'04	163.641	3 680 267 98AB030A12AB
10	Fijac. rejilla parabrisas ("torpedo") Galaxy '94->'06 (Eurocode 3550ASCVS)	163.915	1 023 253 95VWA03836CA
10	Fijac. rejilla parabrisas ("torpedo") Transit Connect '02-> (Eurocode 3743ASCV)	164.264	4 556 621 1 045 676 91ABA030A12EC
10	Base soporte parabrisas Fiesta '02->, Fusion '02-> (ver Mazda)	164.611	4 528 283 2S6AA030A12AD

261/

163.766

163.508

162.282

**162.298 - Dcho.
162.299 - Izdo.**

162.409

163.505

163.180

173.080

U.E.	DESCRIPCION	261	Ref. Adaptable
20	Base regulador faro Fiesta '89	162.282	6 184 715 89FG13B128CA
5	Regulador faro Derecho Fiesta '89	162.298	6 186 660 89FG13K040EA
5	Regulador faro Izquierdo Fiesta '89	162.299	6 186 659 89FG13K040DA
25	Taco fijac. faro trasero Escort '95	162.409	
10	Taco fijacion faro Focus '98-'04, Fiesta '01-'08, Sierra	163.180	6 156 396 87BG13N129AA
25	Taco fijac. faro antiniebla a parrilla delantera C-Max, Fiesta '08, Focus '05, Kuga '08	163.505	6 659 902 W700895S300
5	Soporte faro delantero (dcho/Izdo) Focus'05->	163.508	1 324 270 4M5113N060AA
10	Fijac. pilotos traseros C-Max '03->'11, Fiesta '02 y '08->, Focus '98 y '05->, Kuga, Mondeo '00->'07,	163.766	1 128 772 W707612S300
1	Regulador eléctrico faro Galaxy '94->'06 (ver Fiat, Smart, VAG)	173.080	1 041 664 95VW13K193CA

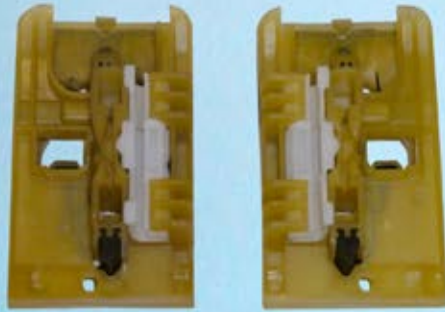

164.444*
Dcho. / Izdo.



164.445*
Dcho. / Izdo.



164.478 - Dcho.
164.479 - Izdo.



164.446* - Dcho.
164.447* - Izdo.



163.988* - Dcho.
163.989* - Izdo.

* (imagen 1/2 tamaño real)

U.E.	DESCRIPCION	261	Ref. Adaptable
1	Soporte cristal elevalunas delantero derecho Transit Connect '02->	163.988	
1	Soporte cristal elevalunas delantero izquierdo Transit Connect '02->	163.989	
1	Kit soporte cristal elevalunas delantero Focus '11->	164.444	
1	Kit soporte cristal elevalunas delantero Mondeo '07->	164.445	
1	Soporte cristal elevalunas trasero derecho Mondeo '07->	164.446	
1	Soporte cristal elevalunas trasero izquierdo Mondeo '07->	164.447	
1	Soporte cristal elevalunas delantero derecho Ford Fiesta '02->	164.478	
1	Soporte cristal elevalunas delantero izquierdo Ford Fiesta '02->	164.479	



163.570 *- Dcho.
163.571 *- Izdo.

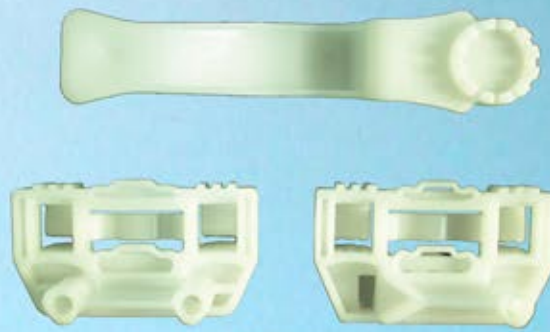

163.370 *- Dcho.
163.371 *- Izdo.



164.073



164.374*
Dcho. / Izdo.

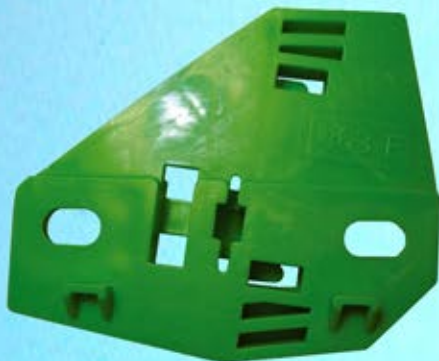

163.568*- Dcho.
163.569*- Izdo.



163.564*- Dcho.
163.565*- Izdo.



163.566*- Dcho.
163.567*- Izdo.

* (imagen 1/2 tamaño real)

U.E.	DESCRIPCION	261	Ref. Adaptable
1	Kit reparación elevalunas delantero derecho Focus '98->'04	163.370	
1	Kit reparación elevalunas delantero izquierdo Focus '98->'04	163.371	
1	Soporte cristal elevalunas Galaxy, puerta derecha (ver VAG)	163.564	
1	Soporte cristal elevalunas Galaxy, puerta izquierda (ver VAG)	163.565	
1	Soporte cristal elevalunas trasero derecho Focus '98->'04	163.566	
1	Soporte cristal elevalunas trasero izquierdo Focus '98->'04	163.567	
1	Soporte cristal elevalunas derecho Fiesta '96->'02, Ka '97->'08, Mondeo '93->'00	163.568	
1	Soporte cristal elevalunas izquierdo Fiesta '96->'02, Ka '97->'08, Mondeo '93->'00	163.569	
1	Soporte cristal elevalunas trasero derecho Fiesta '96->'02	163.570	
1	Soporte cristal elevalunas trasero izquierdo Fiesta '96->'02	163.571	
10	Fijac. elevalunas Fiesta '08->	164.073	1 513 456 W713919S300
1	Kit soporte cristal elevalunas delantero Fiesta '02->'08, Fusion '02	164.374	

261/



164.721 *- Izdo.



164.333 *- Izdo.

164.332 *- Dcho.



164.720 *- Dcho.



164.723 *- Izdo.



164.335 *- Izdo.

164.334 *- Dcho.



164.722 *- Dcho.

* (imagen NO a tamaño real)

U.E.	DESCRIPCION	261	Ref. Adaptable
1	Soporte parachoques delantero derecho Focus '08->'11	164.332	1 521 605
1	Soporte parachoques delantero izquierdo Focus '08->'11	164.333	1 521 607
1	Soporte parachoques delantero derecho Focus '11->	164.334	1 718 730
1	Soporte parachoques delantero izquierdo Focus '11->	164.335	1 718 731
1	Soporte parachoques delantero derecho C-Max '10->'15 y '15->	164.720	1 715 356
1	Soporte parachoques delantero izquierdo C-Max '10->'15 y '15->	164.721	1 715 357
1	Soporte parachoques trasero derecho C-Max '10->'15 y '15->	164.722	1 715 156
1	Soporte parachoques trasero izquierdo C-Max '10->'15 y '15->	164.723	1 715 158



U.E.	DESCRIPCION	261	Ref. Adaptable
25	Fijac. rejilla frontal Fiesta (ver VAG)	162.257	1 500 238 E826110S
10	Fijac. tubo lavacrystal y varilla capó Fiesta '89	162.651	6 183 092
10	Fijac. cableado motor Fiesta, Escort (ver BMW, Opel)	162.918	6 105 034 82GG14197D2A
10	Fijac. varilla capó Fiesta '96	162.952	1 051 701
25	Fijac. varilla capó Fiesta '96, Focus, Ka, Mondeo, Transit	163.016	6 870 622 1 629 999
10	Clip fijacion varilla capó Escort, Fiesta ->'02, Ka, Transit ->'00	163.233	6 068 981
25	Fijac. insonorizantes capó y tapizados interiores Focus '05->, Galaxy '06->, Kuga '08->, Mondeo '07 y '14->, S-Max '06->	163.440	1 251 866 W709688S300
10	Fijac. varilla soporte capó Galaxy '06->, Mondeo '07->, S-Max, Transit '06->	163.765	1 216 747 W709046S300
10	Fijac. moldura inferior puerta Focus '11->'14 y '14->	164.044	1 692 599 W790225S900
10	Fijac. moldura inferior puerta C-Max '11-> y Grand C-Max '15->	164.045	1 683 812 W715364S300
25	Fijac. moldura inferior puerta C-Max '03->'10, Focus '04->'11	164.068	1 450 985 W711638S300
50	Fijac. moldura puerta Transit '14->, fijac. moldura superior puerta Transit Tourneo '12->	164.542	5 255 437 W716507S300
10	Fijac. moldura inferior puerta Mondeo '14->	164.588	5 234 172 W716350S300
25	Fijac. moldura aleta y talonera puerta Kuga '13-> (ver Opel)	164.802	5 264 089 W716351S300
25	Fijac. moldura talonera puerta Edge '15->, Fiesta '12->, Kuga '13->, Mustang '15-> (ver Opel)	164.803	5 270 438 W716352S300



162.423

161.420

162.548

162.230

162.953

162.950

163.681

163.682

164.590

164.262

162.235

162.231

162.973

163.741

163.960

U.E.	DESCRIPCION	261	Ref. Adaptable
50	Fijac. panel puerta Fiesta, Escort (ver BMW, Mini)	161.420	6 117 693
25	Fijac. panel puerta y revestimientos interiores Fiesta, Galaxi (ver VAG)	162.230	
50	Fijac. panel puerta Fiesta y Sierra	162.231	6 099 812 E865063S
50	Fijac. panel puerta - varios modelos - (ver BMW, VAG)	162.235	
50	Fijac. revestimientos interiores Fiesta	162.423	1 443 038 3014E7902358AFA
50	Fijac. tapicería (color verde)	162.548	1 591 426
25	Fijac. revestimientos parachoques Ka	162.950	1 038 008 W704309S300
50	Fijac. revestimientos interiores Fiesta '89 y '96 (ver Mercedes)	162.953	E865220S
50	Fijac. panel puerta Focus '98	162.973	1 070 107
50	Fijac. panel puerta Fiesta '12, Focus '04, C-Max '03->'07, fij. portón trasero Fiesta '02->'08 y '08->	163.681	1 214 485 W709011S300
50	Fijac. panel puerta Fiesta '02->'08 y '08->, C-Max '03->'07	163.682	1 208 973 1 552 662 W709010S300
25	Fijac. tapizados portón trasero Transit '00->'06 y '06->, fij. tapizados puerta Transit Connect '02	163.741	4 097 718 W705364S300
25	Fijac. revestimientos interiores puerta Fiesta '02->'08	163.960	1 144 718 W708355S300
25	Fijac. moldura retrovisor Focus '08->'11, Kuga	164.262	1 684 265 9V4114197AA
50	Fijac. panel puerta Fiesta '12->	164.590	1 831 519 CA6147933AB



162.372



163.594



164.094



164.076



163.441



162.810



163.013



163.090



164.524



163.685



162.847



164.659



163.754



164.591

U.E.	DESCRIPCION	261	Ref. Adaptable
100	Fijac. panel puerta Transit '00 y '06 (ver PSA y Renault)	162.372	4 046 124 W705254S300
50	Fijac. panel puerta Fiesta '89-'96, Escort '95, Ka '97	162.810	6 176 723 E865682S
50	Fijac. tapizados puerta Focus, Galaxi, Explorer, Windstar (Eurocode 3550SSCVFDX) (ver VAG)	162.847	1 008 068 3 865 953 95VWA310A46DB
25	Fijac. panel puerta Ka, Focus, Fiesta, '96, Puma (ver Fiat)	163.013	1 020 732 W704402
25	Fijac. panel puerta Fiesta '02, Fusion	163.090	1 044 806 W704165S300
10	Fijac. panel puerta Focus '04, C-Max '03->'10	163.441	1 257 376 W709004S300
25	Fijac. panel puerta C-Max '11->, fijac. spoiler trasero Focus '11-> (Eurocode 3577SSCMFD) (ver Nissan, Opel, PSA)	163.594	4 860 409 W713489S300
25	Fijac. tapizados portón trasero Focus '04, C-Max '03->'07	163.685	1 360 385 3M5128774BB
25	Fijac. panel puerta Fiesta '08->, Kuga, fij. revestimientos interiores Fiesta '08, Mondeo '07, S-Max (ver Land Rover, Mini, Volvo)	163.754	1 387 954 W712417S300
25	Fijac. panel puerta y tapiz. interiores Ecosport '14->, Focus '11-> y '14->, Galaxy '15->, Kuga '13->, Mondeo '14->, Ranger '11->, S-Max '15->, Transit '14->, Transit Connect '13->, fijac. soportes parachoque trasero Edge '15->	164.076	4 831 516 W713297S300
25	Fijac. panel puerta C-Max '11-> (Eurocode 3577SSCMFD1H)	164.094	5 179 085 W716094S300
25	Fijac. moldura puerta Transit '14->, Transit Connect '13->, Transit Tourneo Custom '12-> (ver Land Rover)	164.524	1 571 079 W714231S300
50	Fijac. tapizados interiores Fiesta '12->, Transit Connect '13->	164.591	1 688 119 W715324S300
25	Fijac. tapizados interiores Transit Connect '13->	164.659	1 838 813 W790255S900

162.261

162.262

163.135

163.684

162.971

162.972

163.914

181.404*

164.026

162.266

* (imagen NO a tamaño real)

U.E.	DESCRIPCION	261	Ref. Adaptable
25	Fijac. moldura cristal Fiesta	162.261	6 040 784
25	Fijac. vierteaguas Fiesta	162.262	6 053 937
25	Fijac. anagramas modelos (ver Opel)	162.266	
25	Fijac. varilla puerta C-Max, Escort '95, Fiesta ->'08, Focus '98 y '05->, Puma, S-Max '06->, Transit Connect '02	162.971	6 758 612 W700930S300
25	Fijac. cableado puerta Escort, Fiesta ->'02, Focus '98->'04, Galaxy, Mondeo '93->'07, Transit	162.972	6 180 955 91AG14197AFA
50	Fijac. juntas estanqueidad Ford Fiesta '02, Fusion (ver PSA, Renault)	163.135	
25	Fijac. juntas goma puerta Mondeo '00->'07	163.684	1 042 065 W702985S300
10	Fijac. aletas Ka '96->, Street Ka	163.914	1 041 646 97KB17N800AE
10	Fijac. varios usos - varios modelos - (ver BMW, VAG)	164.026	
-	Tirante bandeja posterior Ford Fiesta, Sierra (long.total 365 mm.)	181.404	1 648 812 87BBA46812AYYB7



162.385



163.230



163.683



162.844



163.686



162.951



164.260



163.900



163.721

U.E.	DESCRIPCION	261	Ref. Adaptable
25	Fijac. tapicería Fiesta '89	162.385	6 142 786 E864181S
50	Botón + boca fijación revestimientos interiores Galaxi (ver Opel, VAG)	162.844	1 065 204 95VW257K42AA
25	Boca fijac. revestimientos parachoques Ka (monta en 162.950)	162.951	1 031 769 W704411S300
25	Fijac. tapizados Galaxi (ver VAG)	163.230	
25	Fij. revestimientos interiores C-Max, Fiesta '96->'01 y '02->, Focus, Kuga, Mondeo '93->'07 y '07->, Transit '94->'06 y '06->, Transit Connect (Eurocode 3556ASCHS)	163.683	1 020 193 6 877 869 W704258S300
25	Fijac. tapizados portón trasero Focus '04	163.686	1 424 916 W711022S300
25	Fijac. tapizados puerta Mondeo '07, fijac. parachoques Ka '96->, fij. tapizados interiores Fiesta '02, Fusion '02	163.721	1 029 182 W704453S300
10	Fijac. junta panel puerta trasera Focus '98->'04	163.900	1 097 787 W706236S300
10	Fijac. tapizados interiores C-Max '11->	164.260	1 690 698 AM5114A169AB

6,7 x 6,7
Tornillo Ø 3,9



162.963

6,7 x 12,9
Tornillo Ø 2,9



162.851

7 x 11,7
Tornillo Ø 4,2



163.767

7 x 7
Tornillo Ø 3



162.238

7 x 7
Tornillo Ø 4,2



162.715

7,5 x 10
Tornillo Ø 5,5



163.351

7,5 x 11,4
Tornillo Ø 2,9



163.298

7,5 x 8,5
tornillo Ø 5



163.921

7,5 x 10,5
Tornillo Ø 2,9



164.062

7,6 x 8,4
tornillo Ø 5



163.368

8 x 10
tornillo Ø 5,5



162.955

8,2 x 8,2
Tornillo Ø 4,2



163.439

8,6 x 7,7
Tornillo Ø 4,2



164.061

U.E.	DESCRIPCION	261	Ref. Adaptable
100	Taco fijac. - varios usos - Fiesta (ver Fiat, Renault, Seat)	162.238	1 416 795 114301ES
50	Taco fijac. pasoruada y varios usos Escort '95, Fiesta '89-'96, Fiesta '96, Focus '98, Galaxi '06, Ka '97, Puma '98, Mondeo '97, S-Max	162.715	6 695 013 W700578S300
50	Taco fijac. pasoruada Escort'95, Fiesta'96, Mondeo, fijac. portón trasero Escort, fijac. tapizados Granada, Sierra	162.851	1 634 125 E826292S
25	Fijac. pasoruada Ka, Fiesta'89, Fiesta'96, Granada, Puma, Escort, Mondeo, fijac. moldura exterior Escort, fijac. rejilla Mondeo '96-'00, fijac. tapizados interiores Mondeo '00-'07	162.955	6 150 260 E826163S
50	Fijac. intermitente del. a parachoques Focus '98, fijac. panel puerta delantero Transit '00-'06 (monta con 164.685)	162.963	1 027 000 W702087S300
50	Taco fijac. revestimientos interiores Mondeo '94-'00 y '00-'07	163.298	6 195 721 W700078S300
25	Taco fijac. parachoques Mondeo '96-'00, Fiesta '08, fij. deflector interior Mondeo '00-'07, Kuga '13-> fijac. columna dirección Fiesta '08, fij. protectores motor Escort, Grand C-Max '15->, Mondeo, Puma	163.351	1 019 377 W704408S300
25	Taco fijac. aletas y pasoruada C-Max, Focus '98->'04 y '05, Transit Connect '02, fijac. capó Mondeo '00-'07	163.368	1 060 318 W703069S300
50	Taco fijac. revestimientos interiores Fiesta '02, Focus '05, C-Max, parachoques delantero Transit '06 (ver Opel)	163.439	1 335 795 W709859S300
50	Taco fijac. parachoques trasero Ka '96->, fijac. tapizados puerta Focus '04->, C-Max '03->'07	163.767	1 060 382 W703829S300
50	Taco fijac. moldura inferior puerta Focus '04, C-Max '03->'11, fijac. moldura lateral Focus Berlina '98	163.921	1 073 073 W706006S300
50	Taco fijac. parachoque Transit '06->, fij. tapizados interiores Fiesta '02->'08, Focus '04->'11, Fusion	164.061	1 335 795 W709859S300
25	Taco fijac. panel puerta Fiesta '08->	164.062	1 522 126 8A61226B50AB

9,5 x 9,5
Tornillo Ø 4,8



162.480

9,5 x 9,5
Tornillo Ø 6,35



163.367

9,5 x 14
Tornillo Ø 4,8



163.180

10 x 10
Tornillo Ø 4,8



163.393

10 x 10
Tornillo Ø 4,8



162.928

10 x 10
Tornillo Ø 5,5



162.718

10 x 13
Tornillo Ø 5,5



162.811

10 x 14
Tornillo Ø 6



163.443



164.660

U.E.	DESCRIPCION	261	Ref. Adaptable
50	Taco fijación puerta Escort '95, Fiesta '89, Focus, Ka, Mondeo '93-'00	162.480	1 659 672
25	Taco fijac. pasoruada Ford - varios - (ver Fiat)	162.718	
50	Taco fijac. rejilla radiador Fiesta '89-'96, Escort'95, Mondeo'97, Ka'97, Puma'98, y fijación óptica delantera Ka	162.811	6 078 784 81AG13N129AA
25	Taco fijac. pasoruada Fiesta '89 (ver Fiat)	162.928	
10	Taco fijacion faro Focus	163.180	6 156 396 87BG13N129AA
25	Taco fijac. parachoques y torpedo Fiesta, C-Max '03 y '11->, fijac. parachoques Fiesta '02, Fusion, fijac. apertura capó Focus '98 y '05, Mondeo '93->'07, fijac. codo lavaparabrisas Transit Connect '02	163.367	6 549 354 90BG17K657AA
25	Taco fijac. panel puerta B-Max '12->, C-Max '10 y '15->, Focus '11 y '14-> (ver VAG)	163.393	1 725 489
25	Taco fijac. puertas Fiesta '89->'96, Escort	163.443	6 084 040 E826222S
25	Fijac. parachoque trasero Mondeo '14->	164.660	1 863 377 W717648S300



U.E.	DESCRIPCION	261	Ref. Adaptable
25	Fijac. tapizados interiores Escort '91-> y '97-> (color gris)	162.381	E866061SSYNB
50	Fijac. revestimientos interiores Fiesta, Escort, Transit (color gris)	162.382	1 018 433 W704218SSMJCP
50	Fijac. revestimientos interiores Fiesta, Escort (color negro)	162.383	6 725 950 E866202SYNB3
50	Botón fijac. aislamiento capó y tapizados interiores Connect, Cougar, Fiesta '01 y '08->, Focus '98, Escort, Ka, Mondeo '94-'07, Puma, Transit '00 y '06->, Transit Connect '02	162.658	6 678 518 W700671S300
50	Fijac. revestimientos interiores Fiesta, Escort, Transit '94-'00 (color gris claro) (ver Nissan)	162.910	1 018 434 W704218SSYEDQ
25	Fijac. revestimientos interiores Fiesta '89 y '96	162.954	1 047 847 W704294S300
25	Fijac. tapizados interiores Escort '91-> y '97-> (color negro)	162.960	E866061SSYNB
50	Fijac. tapizados interiores e insonorizante capó Transit '06 (ver VAG)	163.129	1 370 597 W704128SSYYJ6
25	Fij. tapiz. interiores Escort, Fiesta ->'12 y '12, Granada, Sierra, fij. aislador techo Transit Connect '02 fijac. deflector aire Mondeo '00, fij. insonorizante Focus '98->'04 y '05->, C-Max '03->'11, Kuga '08	163.742	6 560 532 W700185S300
10	Fijac. soporte parachoques trasero Galaxy '06->, S-Max '06	163.878	4 740 548 W709571S300
50	Fijac. parachoques Ka '16-> (ver PSA)	164.092	6 800 422
25	Fijac. tapizados interiores Focus '04->'11, Kuga	164.095	1 345 085 W710911S300
50	Fijac. pasoruada y parachoques Kuga '13->	164.783	5 143 241 W715926S300



U.E.	DESCRIPCION	261	Ref. Adaptable
50	Botón fijac. revestimientos e insonorizante capó Focus'98, Mondeo (ver BMW, Opel, VAG)	162.782	6 998 849 1 079 129 W702846S300
25	Fijac. tapizados interiores -varios modelos- (ver Dacia, PSA, Renault)	162.941	6 142 789
50	Fijac. revestimientos (tornillo Ø 6) (ver BMW, Mini, Opel, VAG)	162.948	
50	Fijac. moldura guardabarros Fiesta '89 (tornillo Ø 3,9)	162.949	6 634 877 W700980S300
25	Fijac. pasoruada Fiesta '89	162.956	6 185 845 E864338S
50	Fijac. aislante capó y revestimientos interiores Ka (ver Volvo)	162.959	6 786 759 W702122S300
25	Fij. tapizados interiores C-Max '11, Fiesta '12, Focus '04->, Galaxy, Mondeo '93->'14, S-Max '06->, Transit '06->, fijac. deflector delantero Fiesta '02->'12 y '12->, Fusion '02->	163.722	6 717 617 W700673S300
25	Fijac. parachoques delantero Fiesta '08->, fijac. tapizados piso Transit '06->	163.744	4 052 617 W706358S300
50	Fijac. rejilla parabrisas Ka '08-> (ver Dacia, Fiat, Mercedes, Smart)	163.830	1 580 312 W303562
50	Fijac. tapizados interiores Ka '08-> (ver Fiat, PSA)	164.059	1 554 685 W303392
25	Fijac. parachoque y pasoruada Galaxy '06, Mondeo '07, S-Max '06	164.403	1 355 093 W711304S300
25	Fijac. insonorizante capó Transit '14->	164.661	1 767 022 W715950S300
25	Fijac. pasoruada Kuga '13->	164.662	4 685 267 W705681S300



U.E.	DESCRIPCION	261	Ref. Adaptable
50	Fijac. rejilla parabrisas ("torpedo") Fiesta, Escort, Sierra, Mondeo, Transit II ('86->'97) (Eurocode 3731/3539ASCBS) (ver VAG)	162.812	6 114 021 E864164S
50	Fijac. pasoruada Escort'95, Fiesta'96, Mondeo'93-> y '97->	162.852	6 743 363 1 629 549 W700615S300
25	Fijac. pasoruada Fiesta '96, Focus, C-Max, Mondeo '00-'07, y parachoques delantero Focus '05, C-Max, fijac. parachoques trasero Fiesta '02-'08, Mondeo '07, fijac. deflector aire Kuga '08	162.957	1 007 932 96FG16K262AA
50	Fijac. tapizados puerta y fardo delantero Fiesta '02, Fusion, Focus '98-'04 (ver Mazda)	163.369	1 088 761 W706182S300
25	Fijac. moldura aleta trasera Transit '14->, fijac. tapizados interiores S-Max, Galaxy '06->	163.442	4 605 824 W709176S300
10	Fijac. parrilla radiador Focus '01-> y '04->, C-Max '03 y '07->, Kuga '08, Mondeo '00->'07, Transit Connect '02->	163.735	1 125 799 1S7X8C162AA
25	Fijac. panel puerta Fiesta '08->, fij. tapizados interiores C-Max fijac. insonorizante parrilla radiador Fiesta '12->, Transit Courier '14-> (ver VAG)	163.810	4 432 057 1 354 124 W703915S300
50	Fijac. parachoque y parrilla radiador C-Max '11, Focus '11, Ka '16, Transit Connect '13-> Transit Courier '14->, fijac. talonera puerta y tapiz. interiores Focus '14->, Galaxy '15->, S-Max '15-> fij. pasoruada Edge '15, Galaxy '06 y '15->, Mondeo '07 y '14->, Mustang '15->, S-Max '06 y '15-> fij. deflector parachoques Fiesta '08 y '12-> Ka '16->, fij. bajos carroceria Focus '14-> (ver Opel)	164.043	4 855 809 4 902 755 W713610S300
25	Fijac. pasoruada Fiesta '08-> (ver Mazda)	164.055	4 179 287 YL8416K194HCA
25	Fijac. pasoruada C-Max '11->, Focus '11 y '14->, Grand C-Max '15->, Transit Connect '13	164.056	1 382 744 W711289S300
25	Fijac. parrilla radiador Transit '06->	164.784	1 405 776 W703243SSYYJ6
25	Fijac. panel puerta y tapizados interiores Fiesta '08->'12	164.785	1 673 046 8A6116K262AB
25	Fijac. protector bajos carroceria Mondeo '14->	164.807	1 798 297 W716592S300
25	Fijac. panel puerta y insonorizante portón trasero Transit Connect '13-> fijac. tapizados interiores Transit '14->	164.808	5 241 069 1 783 872 W716993SS35B8 W715993SS3YYW



U.E.	DESCRIPCION	261	Ref. Adaptable
100	Fijac. varios usos Ford (ver Mercedes, Opel, PSA, VAG)	162.373	1 104 880
25	Fijac. pasorueta Fiesta, Escort	162.425	
50	Fijac. pasorueta Galaxi '94-'06 (ver VAG)	162.632	7 200 671
25	Fijac. revestimiento portón trasero Escort '97, Fiesta '89 y Fiesta '96	162.958	6 181 023 E844072S
50	Fijac. rejilla lavaparabrisas "torpedo" Fiesta '02, Fusion, fijac. parachoques Mondeo '96-'00 y '14->, fijac. parachoques trasero Kuga '13->, fijac. bajos carrocería Mustang '15->, Ecosport '15-> (ver Chrysler, Land Rover, Opel, Renault, VAG)	163.091	1 039 463 4 663 587 W704433S300
25	Fijac. aleta y talonera puerta C-Max '11->, Fiesta '12->, Focus '11->, Kuga '08, Transit Connect '13, fijac. parachoques delantero Mondeo '07-> (ver Honda, Mitsubishi)	163.171	1 429 935 W711712S300
50	Fijac. moldura lateral Fiesta '02, fijac. moldura inferior puerta Focus '08, fijac. tapizados interiores Kuga '08 (ver Renault, VAG)	163.306	1 324 866 W709987S300
25	Fijac. parachoque trasero Mondeo '14->, fijac. pasorueta delantero Fiesta '02->'08, Focus '02->'05, Fusion '02->, fijac. aislador salpicadero Fiesta '08->, fijac. tapizados portón trasero Transit '00->'06, fijac. protector interior ruedas traseras Transit '06->.	163.734	1 028 521 W701054S300
25	Fijac. pasorueta trasero Fiesta '08->	163.918	1 639 908 8A61A02737AA
25	Fijac. varios usos C-Max '11, Focus '04-> y '11->, Galaxy '06->, Mondeo '07->, S-Max '06->, fijac. talonera puerta Transit Courier '14-> (ver BMW)	164.051	1 382 745 W711312S300
25	Fijac. pasorueta Fiesta '08-> y '12->, Ka '16->, Transit Courier '14->	164.161	1 738 233 AA6116K194AA
25	Fijac. parachoque delantero Kuga '13->, fijac. bajos carrocería Galaxy '15, Mondeo '14, S-Max '15 (ver Chevrolet, Opel)	164.601	4 862 709 W712196S300
25	Fijac. moldura aleta Kuga '13->, fijac. pasorueta Mustang '15->	164.663	5 055 443 W714975S300



164.208



164.217



164.175



164.615



164.571



164.214



164.215



164.216



163.515



163.516



163.517



163.518



163.805



164.572



164.176



164.570



164.181



164.182



163.804

U.E.	DESCRIPCION	261	Ref. Adaptable
10	Fijac. panel puerta y tapizados interiores - varios modelos -	163.515	91560-S9A-A51
10	Fijac. panel puerta y tapizados interiores - varios modelos -	163.516	38993-634-810
10	Fijac. panel puerta y tapizados interiores Accord '03->'07, Civic '02->'05, CRV '08->, Odyssey '05->	163.517	91560-S9A-A01
10	Fijac. panel puerta y tapizados int. Accord '08->, Civic '05->, CRV '02->, Jazz, Odyssey '05->	163.518	91560-S6A-003
10	Fijac. panel puerta y tapizados int. Accord '94->'02, Civic '02->'05, CRV '97->'01	163.805	91560-SP0-003
10	Fijac. moldura aleta trasera Civic '06->, CR-V '07->, fijac. talonera puerta Accord '08->	164.175	91513-SMG-E01
10	Fijac. moldura portón trasero Accord '08->, CR-V '07->, Insight '10->, Odyssey '08->, fijac. moldura anagrama Jazz '09->, fij. talonera puerta Odyssey '11->	164.208	91513-SJK-003
25	Fijac. moldura puerta Civic '00 y '06->, CR-V '00->'06, MR-V	164.214	75305-SCA-E00 75305-S0A-003
25	Fijac. moldura puerta Civic '90->'00, CR-V '97->'01, Legend '96->'04	164.215	75305-SH2-003
10	Fijac. moldura aleta delantera CR-V '97->'06, fij. moldura puerta Civic '95->'00 (3 puertas)	164.216	75305-SH4-003
10	Fijac. moldura aleta delantera CR-V '97->'06	164.217	90107-S10-003
25	Fijac. moldura aleta Civic '06->, CR-V '12->	164.571	90601-SMG-003
10	Fijac. tapizados interiores Civic '12->	164.572	91560-SZW-003
25	Fijac. moldura aleta trasera CR-V '12->	164.615	90513-T0A-A01
10	Fijac. talonera puerta Accord '90->'07, Civic '92->'00, CR-V '97->'01	163.804	91513-SM4-000
10	Fijac. moldura puerta CR-V '02 y '07->	164.176	75315-S9A-004
10	Fijac. moldura puerta Civic '06->, Jazz '02->'08	164.181	91514-SAA-003
10	Fijac. moldura puerta Civic '06->, fijac. moldura inferior puerta CR-V '02 y '07->	164.182	91504-SP1-003
10	Fijac. moldura portón trasero Accord Tourer, CR-V '02->'07	164.570	90501-S9A-003



163.124



162.947



164.207



164.224



164.223



163.131



163.132



163.123



164.210



164.211



164.212



164.213

U.E.	DESCRIPCION	261	Ref. Adaptable
25	Fijac. moldura parabrisas Concerto SJ4 '91->'95 (ver Rover) (Eurocode 3943ASCHB)	162.947	91517-SJ4-003
25	Fijac. moldura parabrisas Civic '91->'95, Integra (ver Rover) (Eurocode 3940/3948ASCS)	163.123	91520-SR3-003
10	Fijac. rejilla parabrisas Ballade, City, Civic '92->'00 (3 y 5 puertas), CR-V '97->'01, CRX, HRV, Integra, Logo (Eurocode 3948ASCC / 3962ASCRB)	163.124	91515-SR3-000
10	Fijac. moldura parabrisas Civic '91->'95, Integra Coupe '93->'98 (Eurocode 3954ASCH) (ver Rover)	163.131	91511-ST3-E00
10	Fijac. moldura parabrisas Accord '90->'93 (ver Rover) (Eurocode 3936ASCSS6B)	163.132	91525-SM4-003
10	Fijac. rejilla parabrisas "torpedo" Accord '08->, Insight '10->, Jazz '09-> (Eurocode 4003ASCSB)	164.207	90602-TA0-003
10	Fijac. moldura lateral parabrisas Civic '01->'05 (Eurocode 3974ASCHS)	164.210	91519-S6A-003
10	Fijac. moldura lateral parabrisas Civic '01->'05 (Eurocode 3976ASCHS2B)	164.211	91521-S6A-003
10	Fijac. moldura lateral parabrisas Civic '01->'05 (Eurocode 3976ASCHS3B)	164.212	91522-S6A-003
10	Fijac. moldura lateral parabrisas Civic '01->'02 (5 puertas) (Eurocode 3974ASCHS4B)	164.213	91523-S6A-003
25	Fijac. rejilla parabrisas "torpedo" Accord '03->, Civic '00 y '06->, CR-V '01->'06, FR-V '05, Odyssey (Eurocode 3999ASCSB)	164.223	90602-S5A-003
25	Fijac. rejilla parabrisas "torpedo" Civic '06->, CR-V '05->'06, Legend '07->, Odyssey '06->'10 (Eurocode 3998ASCHB7B)	164.224	90602-SFA-004

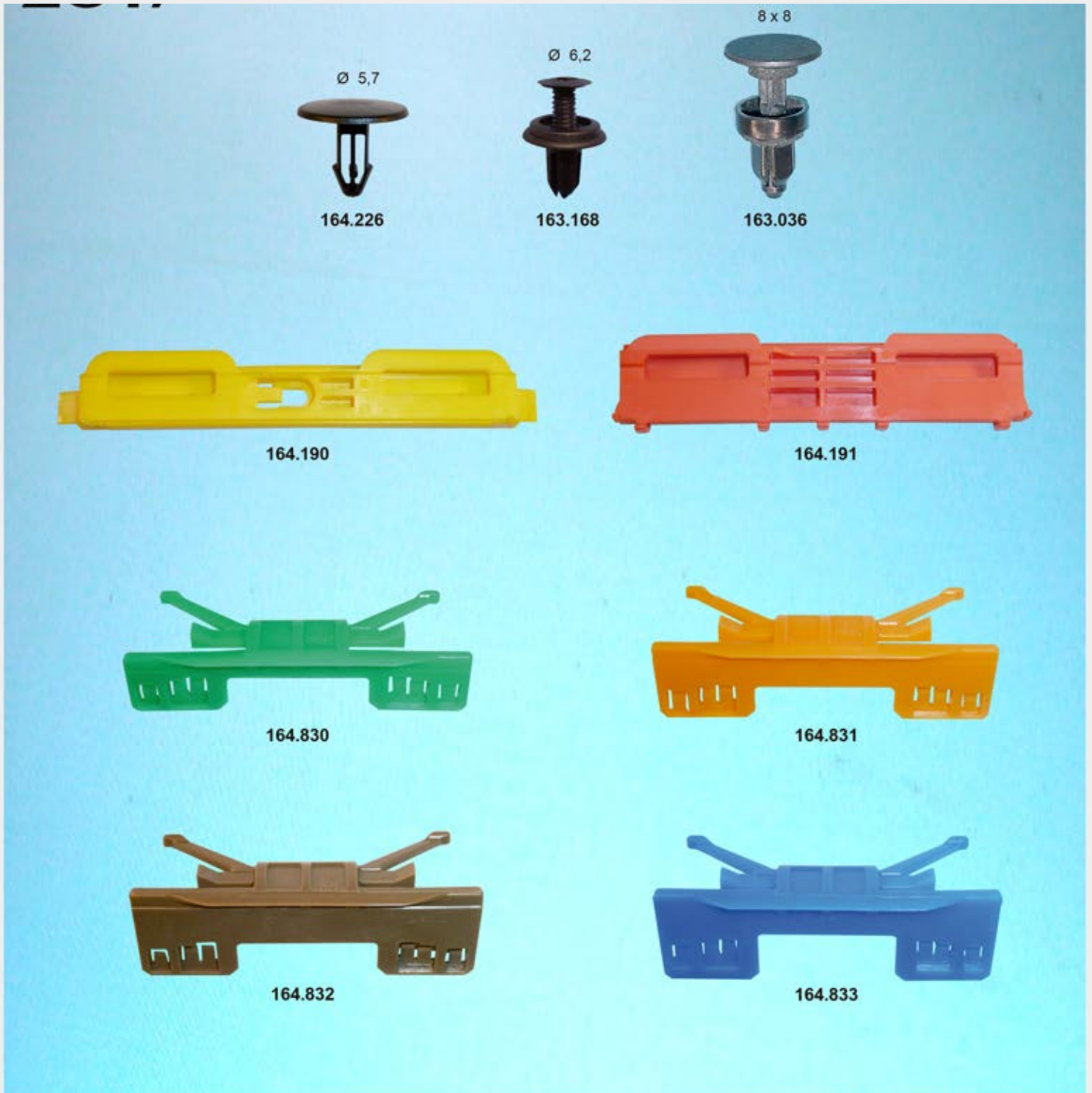

U.E.	DESCRIPCION	261	Ref. Adaptable
10	Fijac. rejilla parabrisas "torpedo" Accord '90->'00, Civic, Legend '96->'00 (Eurocode 3936ASCHB / 7020ASCSS4B) (ver Rover)	163.036	91508-SM4-003
10	Fijac. rejilla parabrisas "torpedo" Prelude ->'91 (Eurocode 3931ASCHB)	163.168	90687-SB0-003
10	Fijac. moldura lateral parabrisas (parte superior) CR-V '07->'12 (Eurocode 4000ASCERS3B)	164.190	91570-SWA-305 91570-SWA-003
10	Fijac. moldura lateral parabrisas (parte inferior) CR-V '07->'12 (Eurocode 4000ASCERS)	164.191	91571-SWA-305 91571-SWA-003
25	Fijac. rejilla parabrisas "torpedo" CR-V '07-> (Eurocode 4000ASCERB)	164.226	91501-SEA-003
10	Fijac. moldura lateral parabrisas (parte superior) CR-V '12->'16 (Eurocode 4011ASCERS6B)	164.830	73154-T0A-003
10	Fijac. moldura lateral parabrisas (parte central) CR-V '12->'16 (Eurocode 4011ASCERS7B)	164.831	73155-T0A-003
10	Fijac. moldura lateral parabrisas (parte central) CR-V '12->'16 (Eurocode 4011ASCERS8B)	164.832	73156-T0A-003
10	Fijac. moldura lateral parabrisas (parte inferior) CR-V '12->'16 (Eurocode 4011ASCERS9B)	164.833	73157-T0A-003



164.566



164.567



164.568



164.569



163.957



164.565



164.620



164.530



164.669



164.668

U.E.	DESCRIPCION	261	Ref. Adaptable
10	Fijac. moldura lateral parabrisas Civic '06->'11, FR-V '04->'09 (Eurocode 3992ASCV2B)	163.957	91570-SJD-003
10	Fijac. moldura lateral parabrisas Accord '03->'07, Civic '06->'11 (Eurocode 3998ASCHDS)	164.530	91570-SDA-A01
10	Fijac. moldura techo-parabrisas Civic '06->'15 (Eurocode 3998ASCHDS6B)	164.565	73157-SMG-E00
10	Fijac. moldura lateral parabrisas (parte inferior) Civic '06->'11 (Eurocode 3998ASCHDS2B)	164.566	73153-SMG-E00
10	Fijac. moldura lateral parabrisas (parte central) Civic '06->'11 (Eurocode 3998ASCHDS8B)	164.567	73170-SMG-E00
10	Fijac. moldura lateral parabrisas (parte central) Civic '06->'11 (Eurocode 3998ASCHDS3B)	164.568	73154-SMG-E00
10	Fijac. moldura lateral parabrisas (parte superior) Civic '06->'11 (Eurocode 3998ASCHDS4B)	164.569	73155-SMG-E00
10	Fijac. moldura lateral parabrisas Civic '06->'11 (Eurocode 3998ASCHDS1B)	164.620	91571-SDA-A01
10	Fijac. moldura parabrisas (parte inferior derecha) Civic '06->'11 (Eurocode 3998ASCHDS5B)	164.668	73156-SMG-E00
10	Fijac. moldura parabrisas (parte inferior izquierda) Civic '06->'11 (Eurocode 3998ASCHDS7B)	164.669	73166-SMG-E00



164.834



164.835



164.836



164.837



164.828



164.829



164.839



164.838

U.E.	DESCRIPCION	261	Ref. Adaptable
10	Fijac. moldura lateral parabrisas Accord '08->, Civic '12->'15, CR-V '12->'16, Crosstour '10->'15 (Eurocode 4010ASCHS8N)	164.828	91570-TA5-A01
10	Fijac. moldura lateral parabrisas Accord '08->, Civic '12->'15, CR-V '12->'16, Crosstour '10->'15 (Eurocode 4010ASCHS9N)	164.829	91571-TA5-A01
10	Fijac. moldura lateral parabrisas (parte inferior) Civic '12->'15 (Eurocode 4010ASCHS)	164.834	73153-TV0-E01
10	Fijac. moldura lateral parabrisas (parte central) Civic '12->'15 (Eurocode 4010ASCHS6B)	164.835	73154-TV0-E01
10	Fijac. moldura lateral parabrisas (parte central) Civic '12->'15 (Eurocode 4010ASCHS7B)	164.836	73155-TV0-E01
10	Fijac. moldura parabrisas (parte superior) Civic '12->'12 (Eurocode 4010ASCHS8B)	164.837	73156-TV0-E01
10	Fijac. moldura parabrisas (parte inferior derecha) Civic '12->'15 (Eurocode 4010ASCHS6N)	164.838	73157-TV0-E01
10	Fijac. moldura parabrisas (parte inferior izquierda) Civic '12->'15 (Eurocode 4010ASCHS7N)	164.839	73167-TV0-E01

164.574

164.225

163.159

164.614

163.191

163.294

163.812

164.206

164.394

164.586

164.205

164.573

U.E.	DESCRIPCION	261	Ref. Adaptable
25	Clip fijac. parrilla radiador - varios mod. - (ver Mazda, Opel, Toyota)	163.159	
25	Fijac. panel puerta y otros usos Civic '96->'05, Odyssey '99->'04	163.191	91530-ST5-003
10	Fijac. revestimientos interiores, junta capó y junta puerta Accord ->'89, Civic ->'91, CRX ->'91, NSX '97->'01, Prelude	163.294	90664-671-003
25	Fijac. junta goma puerta Accord '98->'07, Civic '01->'05	163.812	91568-SR2-003
25	Fijac. junta goma puerta CR-V '97->'06	164.205	72311-S10-003
25	Fijac. junta goma puerta Accord '08->, Civic '01 y '06->, CR-V '07->, HR-V, Insight '10-> (ver Toyota)	164.206	90651-S4N-003
25	Fijac. insonorizante capó Accord '99->'08, HR-V '99->'05, Insight '01->'05	164.225	91501-S1K-003
25	Fijac. junta goma capó Accord '94->'02, Civic '95->'00, CR-V '07->, Insight, Odyssey	164.394	91530-SP1-003
25	Fijac. junta goma puerta Accord '13->, Civic '12->	164.573	91520-SCC-003
25	Fijac. insonorizante capó Accord '13->, Civic '12->	164.574	91501-SWA-003
25	Fijac. junta goma puerta Accord, CR-V '07->	164.586	91530-S0A-003
10	Fijac. junta cristal puerta CR-V '12->	164.614	91503-SWA-A01



U.E.	DESCRIPCION	261	Ref. Adaptable
25	Fijac. revestimientos interiores Accord, Civic, CRX, Integra, Legend, Logo, NSX, Odyssey, Prelude (ver Mazda)	163.172	75522-611-000 75522-611-003
25	Fijac. revestimientos interiores - varios modelos -	163.173	906666890030
25	Fijac. varios usos Accord '99->'02, Prelude '89->'91	163.174	91606-SE3-003
25	Fijac. varios usos Civic, Prelude	163.192	90656-671-631
25	Fijac. revestimientos interiores, pasorueda y otros usos Accord, Civic, CRV, Legend, NSX, Prelude (ver Hyundai)	163.281	90672-671-811
25	Fijac. panel puerta y tapizados interiores Accord -todos-, Civic -todos-, CRV '07->, CRX '84->'91, Element '03->, Insight, Integra, Jazz '07->, Odyssey '95->, Prelude '79->'01, Pilot '03->	163.519	90662-SB2-003
10	Fijac. tapizados portón Accord, Acty, Civic, CRX, HRV, Logo, Prelude, Shuttle, fijac. parachoques Jazz (ver Mazda, Nissan, Toyota)	163.520	90661-SC7-003
10	Fijación tapizados interiores Accord '83->'89, Civic '80->'87, CRX '84->'87, Integra, Legend, Prelude '79->'87	163.618	90672-671-003 90674-SK3-E00
50	Fijac. insonorizante capó Accord '03->, Civic '06->, CR-V, Insight '10->, Jazz	163.896	91518-SM4-003
25	Fijac. pasorueda Accord '03 y '08->	164.219	90682-SEA-003
25	Fijac. aletas Accord '09->'13, Civic '06->'11, fijac. rejilla parabrisas "torpedo" CR-V '07-> (Eurocode 4000ASCRB)	164.226	91501-SEA-003
25	Fijac. pasorueda Odyssey '13->	164.616	90682-SDA-A01
25	Fijac. pasorueda Civic '16->, Odyssey '05->	164.800	91512-SED-003



U.E.	DESCRIPCION	261	Ref. Adaptable
50	Fijac. pasoruada Accord '90-'97, Balade, Civic ->'00, Concerto, CRX ->'91, Integra, Legend, Prelude '90->'95, NSX (ver Rover)	163.035	91512-SM4-003
10	Fijac. rejilla parabrisas Accord '90-'00, Civic, Legend '96-'00 (Eurocode 3936ASCHB / 7020ASCSS4B) (ver Rover)	163.036	91508-SM4-003
10	Fijac. revestimientos interiores - varios modelos -, fijac. "torpedo" parabrisas Prelude ->'91 (Eurocode 3931ASCHB)	163.168	90687-SB0-003
10	Fijac. revestimientos interiores y talonera puerta Civic'92->'00, CRV '00->'01, Integra, Legend, Odyssey '01->'04, Prelude '83->'87 (ver Rover)	163.169	90688-SB0-003 90688-SB0-013
10	Fijac. rejilla entrada de aire Civic '92->'00, CRV '97->'01, Odyssey	163.170	91508-SR3-000
25	Fijac. pasoruada Accord '96->, Civic '96->'06 y '06->, CRV '97->, HRV, Insight, Jazz '07 (ver Ford, Mitsubishi)	163.171	91501-S04-003 90675-SB3-003 90675-SB0-003
25	Fijac. parachoques, molduras pasoruada y tapizados interiores Accord ->'07, Civic '01->, CRV '02->'06, Jazz (ver Nissan, Volvo)	163.277	91545-SE0-003
25	Fijac. pasoruada - varios modelos - (ver Fiat, Lexus, Suzuki, Toyota)	163.476	
25	Fijac. tapizados interiores Accord '03->'07, Civic '01->, CRV '02->'06, Jazz '07->, NSX, S2000 '00-> (ver Mitsubishi, Nissan)	163.482	
25	Fijac. moldura talonera puerta CR-V '97->'06	163.813	90505-SX0-003
25	Fijac. pasoruada Accord '13->, Civic '13->	164.155	91501-TR0-003
10	Fijac. tapizados maletero Accord '11->, Civic '12->, HR-V '17->	164.706	90667TC0U01ZA



U.E.	DESCRIPCION	261	Ref. Adaptable
50	Fijac. revestimiento para choques Accord '92->'97, Civic '01-'02, Concerto, CRX, Legend ->'95, Prelude ->'96 (ver BMW, Chevrolet, Mini, Rover)	163.037	91503-SP0-003
25	Fijac. para choques Accord '92-'97 y otros modelos (ver Daewoo)	163.163	91502-SP0-003 91502-SM4-000
50	Fijac. para choques Accord '97->, Civic '97->, CRV '97->, Jazz '05->, Odyssey '96->, FRV, HRV, Insight, Integra, Legend, NSX, fijac. talonera puerta CR-V	163.164	91503-SZ3-003
25	Fijac. para choques Accord '98->'07, Civic '01->'05, CR-V '02, Element, Jazz, Insight, Odyssey (ver Nissan)	163.802	91503-SZ5-003
25	Fijac. rejilla radiador Accord '03->, Civic '03->'05, FR-V '05->, fijac. pasoruada Insight '10->, fijac. para choques Civic '06->, Jazz '05->,	164.154	91503-S7A-003
25	Fijac. pasoruada y bajos carrocería Accord '08->, Jazz '08->, fij. bajos carrocería Civic '06->	164.177	91505-S9A-003
25	Fijac. talonera puerta y bajos carrocería Civic '06->, fij. bajos carrocería Accord '08->, CR-V '07->, fij. aletas Insight '10->, fij. para choques delantero Jazz '12->	164.178	91506-S9A-003
10	Fijac. pasoruada CR-V '15->, fijac. bajos carrocería Accord '06->	164.707	90501-SDR-003

261/



163.548 - Dcho.
163.549 - Izdo.



164.480 - Dcho.
164.481 - Izdo.

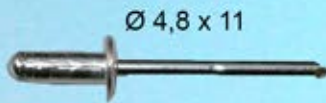

Ø 4,8 x 11

161.868

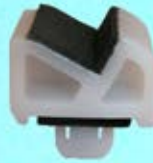

164.428



163.976



164.672



163.700



163.704



164.360



163.701



163.702



163.703



164.813



Ø 7,8

164.842



Ø 8

163.503



Ø 9,5

164.179



Ø 10

164.315

U.E.	DESCRIPCION	261	Ref. Adaptable
1	Soporte cristal elevalunas derecho Accent	163.548	
1	Soporte cristal elevalunas izquierdo Accent	163.549	
1	Kit soporte cristal elevalunas delantero derecho Hyundai I30 '07->'12	164.480	
1	Kit soporte cristal elevalunas delantero izquierdo Hyundai I30 '07->'12	164.481	
50	Remache Ø 4,8 x 11, fijac. moldura parabrisas Hyundai Santa Fe '15->, Sonata '05, Kia Sorento '15	161.868	14160-05130
25	Fijac. pasoruada y parachoques Accent, Azera, Coupé, Elantra, Entourage, Genesis, Getz, H1 '07->, Santa Fe, Sonata, Tucson, ix35, ix55 (Veracruz), XG300/350, Kia Sorento, Sportage (ver Mazda, Toyota)	163.503	86590-28000
25	Fijac. junta goma puerta Hyundai Accent, Atos, Elantra, Santa Fe, Sonata, Tucson, ix55 (Veracruz), Kia Picanto, Rio, Sorento, Sportage	163.700	82134-22000
25	Fijac. junta goma puerta Hyundai Elantra '91->'00	163.701	82852-28000
25	Fijac. junta goma puerta Hyundai Accent ->'99, Atos, Kia 2500/2700	163.702	82134-37000
25	Fijac. junta goma puerta Hyundai Accent '99->'06, Atos, Coupé, Galloper, Santa Fe, Sonata, Kia Sorento, K2500/2700	163.703	82132-27100
25	Fijac. junta capó Hyundai Accent, Elantra, Equus, Santa Fe, Sonata, Tucson, XG300/350, Kia Carnival, Picanto, Rio	163.704	86438-27100 86438-4A100
25	Fijac. insonorizante capó Hyundai Accent '06, Azera '05, Coupé, Elantra, Entourage, Genesis, Santa Fe '03, Sonata, Tucson '04, Veracruz '06, XG300/350, Kia Sorento, Sportage	163.976	81126-37010
10	Fijac. parachoque Santa fe, Tucson '04->'09	164.179	86590-35000
25	Fijac. parachoque Kia Carens, Carnival, K2700, Pregio, Pride, Sorento, Sportage (ver Mazda, Mitsubishi)	164.315	MBF6750033
25	Fijac. junta goma capó Hyundai Accent, Elantra, Santa Fe, Tucson, Kia Cerato, Sorento, Sportage	164.360	86434-4A000
10	Fijac. rejilla parabrisas "torpedo" IX55 '06->'12, Santa Fe '06->'09, Tucson '04->'13	164.428	86123-2E000
10	Fijac. varilla capó Hyundai I30 '12->, Elantra, Sonata, Tucson, Kia Carens, Sportage	164.672	81174-21010
25	Fijac. junta moldura puerta Hyundai Santa Fe '12->, Kia Sorento '15->	164.813	87756-2W000
25	Fijac. pasoruada y parachoques Hyundai Accent '15->, Elantra '17->, Santa Fe '15->, Sonata '15->, Tucson '16->, Kia Carnival '15->, Rio '16->, Soul '14->, Sportage '14->	164.842	86595-2T500



U.E.	DESCRIPCION	261	Ref. Adaptable
25	Fijac. parachoques Hyundai Accent, Santa Fe, Tucson, Kia Sorento, Sportage fijac. revestimientos interiores Hyundai Coupé (Tiburón), Elantra, Sonata (ver Honda)	163.281	97519-22000
50	Fij. moldura lateral Hyundai Getz, Matrix, Santa Fe, Sonata, Tucson, Kia Carnival, Sorento, Sportage fijac. pasoruada Hyundai Accent, Elantra, Genesis, Santa Fe, Sonata, Kia Sorento, fijac. parachoques Hyundai Tucson, ix55 (Veracruz), Kia Sportage	163.688	86848-22000
25	Fijación parachoques y tapizados interiores Accent, Atos, Azera, Elantra, Genesis, Sonata, fijac. moldura lateral Galloper	163.689	85744-28000
25	Fijac. moldura lateral Hyundai Accent, Getz, Matrix, Kia Sorento	163.690	87756-1C000
25	Fijac. moldura lateral Hyundai Accent, Atos, Entourage, Matrix, Santa Fe, Sonata	163.691	87756-35000
25	Fijac. tapizados puerta Hyundai Accent '99, Elantra '00, Genesis, Getz, H1, Santa Fe, Sonata, Tucson, XG300/350, Kia Cerato, Carnival, Picanto, Sorento, Sportage, K2500/2700	163.962	82315-38000 82315-33010 82315-33020
25	Fijac. tapizados interiores Hyundai Elantra '00->'12, Equus, Santa Fe '06->, Kia Carnival '06->, Cerato, Sorento '06->, Sportage '04->	164.358	85849-3B000
25	Fijac. panel puerta y tapizados interiores Hyundai Elantra, Equus, I30 '12->, Santa Fe, Sonata, Tucson, Kia Carnival '06->, Sportage '04->	164.359	82315-27000
50	Fijac. parachoque, pasoruada y otros usos Hyundai Accent, Elantra, I30 '12->, Santa Fe, Tucson, Kia Carnival '06->, Niro '17->, Rio '05->, Sorento '03->, Soul '09->, Sportage '05->	164.543	14910-05000
25	Fijac. panel puerta Hyundai Accent '11->, I30 '12->, Sonata '10->, Tucson '09->, Kia Sportage '16	164.557	82315-2P000
25	Fijac. pasoruada Hyundai Accent, Elantra, Getz, Santa Fe, Sonata, Tucson, Kia Picanto, Rio, Soul	164.558	86825-28000
25	Fijac. pasoruada Hyundai Accent, Elantra, H-1, IX35, Santa Fe, Tucson, Kia Sorento, Sportage '05	164.671	86825-26000
50	Fijac. pasoruada y parachoques Hyundai Elantra, Sonata, Kia Optima y otros modelos	164.677	14913-05010
25	Fijac. panel puerta Hyundai Elantra '17->, Santa Fe '12->, Sonata '16->, Tucson '17->, Kia Carnival '15->, Niro '17->, Optima '16->, Rio '12->, Sorento '15->, Soul '14->, Sportage '17->	164.761	82315-2W000
25	Fijac. faro y parachoque trasero Hyundai Accent '99->, Elantra '06->, I30 '12->, Santa Fe '00->, Tucson '04->, Kia Carnival '06->, Rio '00->, Sportage '05->	164.841	86910-22000



U.E.	DESCRIPCION	261	Ref. Adaptable
10	Fijac. moldura lateral puerta Hyundai Elantra, fij. parrilla radiador Hyundai Sonata	163.266	87770-28000
25	Fijac. parrilla radiador Tucson, fijac. moldura lateral Hyundai Genesis, Sonata, Terracan	163.692	87702-H1000
25	Fijac. parrilla radiador Elantra, fij. moldura lateral Hyundai Terracan	163.693	87703-H1000
25	Fijac. moldura lateral Hyundai Accent, Atos	163.694	87770-02000
25	Fijac. moldura lateral Hyundai Atos, Santa Fe, Kia Picanto, Sorento	163.695	87719-02500
25	Fijac. moldura lateral Hyundai Entourage, I40, Santa Fe, Sonata, Tucson, ix25/Creta, ix35, ix55, Kia Sorento, Sportage '04->'06	163.696	87756-2E000
25	Fijac. moldura lateral Hyundai Azera, Coupé, Tiburon, XG300/350	163.697	87758-39000
25	Fijac. moldura lateral Hyundai Coupé (Tiburón), Entourage, Genesis, Santa Fe, Tucson, ix55, Kia Sorento, Sportage	163.698	87759-27000
25	Fijac. moldura lateral Hyundai Elantra '00, Getz, Sonata, Kia Carnival '06->, Niro '17->, Rio '05->'11	163.699	87756-38000
25	Fijación moldura lateral Hyundai Accent, Atos, Coupé, H-100, I10, ix35, Matrix, Santa Fe, Tucson, Kia Ceed, Picanto, Sorento, Sportage	163.892	87758-35000
25	Fijac. moldura aleta y puerta Kia Cadenza '13->, Sorento '06->'14	164.547	87756-3E500
25	Fijac. moldura aleta y puerta Hyundai I40 '11->, Santa Fe '12->, Tucson/IX35 '11->, Kia Niro '17->, Soul '15->, Sportage '05-> y '15->	164.548	87756-1F000
25	Fijac. moldura parrilla radiador Azera '06->, Equus '10->, Genesis '13->, Sonata '10->	164.578	86360-3L000
25	Fijac. moldura aleta y puerta Hyundai Tucson '15->	164.670	87756-D3000
10	Fijac. moldura talonera puerta Hyundai Tucson/IX35 '09->, Kia Niro '17->, Sportage '17	164.796	87758-2S000
25	Fijac. moldura talonera puerta Hyundai Santa Fe '12->, Kia Sorento '09->'14	164.797	87756-2J000
25	Fijac. moldura puerta Hyundai Accent '00->'06, Atos, Sonata '00->'13, Terracan, Kia Picanto, Soul '15->, Sorento '03->'06	164.820	87758-37000
25	Fijac. moldura aleta y puerta Kia Sorento '15->	164.821	87756-C5000
25	Fijac. moldura lateral puerta Hyundai I10 '13->, I20 '16->	164.847	87756-C8700 87758-B9000
25	Fijac. moldura aleta y puerta Hyundai Santa Fe '12->	164.848	87716-2W000
25	Fijac. moldura portón trasero Hyundai Santa Fe '12->, Kia Carens '12->, Sorento '15->	164.851	87382-2W000



164.612
Dcho. / Izdo.



163.658



163.639



164.018



164.549



164.035



164.523



163.417



164.193



164.192



164.604



164.664



164.667



164.302



163.333

U.E.	DESCRIPCION	261	Ref. Adaptable
1	Soporte cristal elevalunas trasero derecho e izquierdo Freelander	163.658	
1	Kit soporte cristal elevalunas delantero Freelander (ver VAG)	164.612	
25	Fijac. moldura parabrisas Range Rover (P38) '95->'01 (Eurocode 7024ASCR)	163.333	DCE 10038L
25	Fijac. moldura inferior parabrisas Evoque, y Range Rover '02 y '10-> (Eurocode 7042ASSRS) (ver Mercedes)	163.417	LR002229 DYA 000040
25	Fijac. moldura parabrisas Range Rover '02->'09, Range Rover Sport '05 y '10->, Discovery 3 y 4 (Eurocode 7033ASCRS)	163.639	DYC 500020 DZM 000070
10	Fijac. moldura parabrisas Discovery 3 y 4 '05->'16, Range Rover '02 y '10-> (Eurocode 7032ASCRS2B)	164.018	IPN 500050
25	Fijac. rejilla parabrisas "torpedo" Range Rover '02->'09 y '10->'12 (ver BMW)	164.035	JYC 000070
25	Fijación moldura parabrisas Discovery 2 '98->'04 (Eurocode 7033ASSRS)	164.192	79086L
25	Fijac. rejilla parabrisas "torpedo" Range Rover Evoque (Eurocode 7042ASSRS1B)	164.193	LR033144
10	Fijac. moldura techo Range Rover '10->	164.302	DBE 000011
10	Fijac. rejilla parabrisas "torpedo" Range Rover '02->'09 y '10-> (Eurocode 7033ASCRB)	164.523	CYC 000010
10	Fijac. moldura parabrisas Discovery 4 '10->, Range Rover Sport '10->'13 (Eurocode 7032ASCRS3B / 7036ASCRS7B)	164.549	LR053837 LR034389
10	Fijac. moldura parabrisas Range Rover Sport '05->'09 y '10->'13	164.604	DYQ 500060
10	Fijac. rejilla parabrisas "torpedo" Freelander '00->'07 (Eurocode 7028ASCRB)	164.664	DYQ 000010
5	Fijac. rejilla parabrisas "torpedo" Range Rover Evoque, Freelander '07 (Eurocode 7042ASCRS)	164.667	LR002228



U.E.	DESCRIPCION	261	Ref. Adaptable
25	Fijac. moldura inferior puerta Discovery 3 y 4 '05->, Evoque, Freelander y Range Rover '02-> (ver Opel, Renault)	163.141	DYC 101420
25	Fijac. panel puerta Discovery '05->'09 y Range Rover Sport '05->'10, fijac. tapizados inter. Evoque, Discovery 3 y 4, Evoque, Freelander '07, Range Rover '05->'12 y Range Rover Sport '05->	163.754	EYC 106710 EYC 500120
25	Fijación panel puerta Discovery 1 y 2 '94->'04, Freelander '96->'06 y Range Rover '95->'02	164.066	MWC9134
25	Fijación panel puerta Freelander '07->	164.067	LR003015
25	Fijación parachoques Discovery 3 '05->, Range Rover '02->'09	164.074	DYR 500010
25	Fijación parachoques Discovery 3 '05->, Range Rover '02->'09	164.075	DYF 500010
25	Fijación moldura aleta Discovery 4 '10->	164.123	DYC 500040
10	Fijac. moldura puerta Range Rover '10->	164.147	DYC 000091
10	Fijac. moldura puerta Range Rover '10->	164.148	DYC 000122
25	Fijación pasoruada Discovery 4 '10->	164.170	DYC 500010
25	Fijación moldura pasoruada y tapizados interiores Range Rover Evoque	164.354	LR027255
25	Fijac. panel puerta y tapizados interiores Discovery 3 y 4 '05->, Evoque '12->, Freelander '07->, Range Rover '13->, Range Rover Sport '05 y '14-> (ver Ford)	164.524	LR013135
10	Fijación spoiler delantero Discovery IV '10->, Range Rover '10->, Range Rover Sport '10->	164.550	LR012844
25	Fijación moldura aleta trasera Discovery IV '10->	164.551	DYC 500110
25	Fijación moldura aleta y puerta Range Rover Evoque, Range Rover '13->, Range Rover Sport '14->	164.552	LR032984 LR031670
25	Fijación moldura inferior puerta Range Rover Evoque, Range Rover '13->, Range Rover Sport '14->	164.564	LR028939
25	Fijación parachoque delantero Discovery 3 y 4 '05->, Range Rover Sport '05->'13	164.643	DYH 500131



U.E.	DESCRIPCION	261	Ref. Adaptable
50	Fijac. insonorizantes y rejilla deflector aire Range Rover '02->'09 (ver BMW, Mercedes, Mini, Smart, VAG)	163.044	EYQ 100120
50	Fijac. aletas y pasoruada Evoque, fij. pasoruada Discovery '05->'09 y Range Rover (ver Chrysler, Ford, Opel, Renault, VAG)	163.091	ANR 2224
25	Fijac. moldura parabrisas, moldura pilar "D" y juntas puerta Range Rover '02->'09 y '10->'12	164.063	DYC 000150
50	Fijac. talonera puerta Range Rover '13->, Range Rover Sport '14->	164.100	HYQ100060PUY
25	Fijac. talonera puerta Range Rover '92->'01, Discovery 1 y 2 '89->'04, fijac. pasoruada Freelander	164.192	79086L
25	Fijac. moldura pilar "D" Range Rover Evoque	164.193	LR033144
25	Fijac. pasoruada Range Rover Evoque, Freelander '07->	164.313	RYQ 500070
10	Fijac. moldura pilar "D" Range Rover Sport '05->'09 y '10->'13	164.604	DYQ 500060
10	Fijac. rejilla parabrisas "torpedo" Freelander '00->'07 (Eurocode 7028ASCRB)	164.664	DYQ 000010

Ø 5,2 x 19
arandela Ø 12



161.846

Ø 3,8 X 6,2



161.845

Ø 4 x 13



161.871

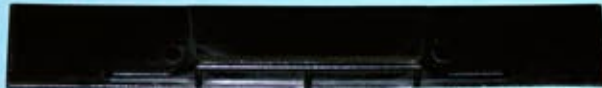

163.706



163.359



163.650



164.418



164.619

U.E.	DESCRIPCION	261	Ref. Adaptable
25	Remache Ø 3,8 x 6,2, fijac. juntas puerta RX450 (ver Toyota)	161.845	90269-04051
25	Tornillo Ø 5,2 x 19 (aro Ø 12), fijac. parachoques RX350/450 (ver Toyota)	161.846	75392-42030
10	Remache Ø 4 x 13, fijac. moldura parabrisas RX450H '15-> (ver Toyota)	161.871	75547-51021
10	Fijac. moldura parabrisas GS300, GX460, LS430, LS460, LS600H, LX570 (Eurocode 8310ASCH) (ver Toyota)	163.359	56115-30100
10	Fijac. moldura lateral parabrisas IS F '08->, GX460 '09-> (Eurocode 8371ASCSS) (ver Toyota)	163.650	75545-53010
10	Fijac. moldura superior parabrisas IS F, IS 250C, LS430/460/600, LX570, GS30/35, GS450, GX460, RX300/350/400H/450H (Eurocode 8310ASCH6B) (ver Toyota)	163.706	56116-22050
10	Fijac. moldura lateral parabrisas GS30/35/43 '05->'11, GS450H '06->'11, LS460 '06->, LS600 '07-> (Eurocode 8362ASCSS2B)	164.418	75562-30070
10	Fijac. moldura parabrisas IS '13->, GS '12->, RC '14->, RX450H '15-> (Eurocode 8416ASCSS) (ver Toyota)	164.619	75545-30170



163.251



163.250



163.621



163.162



163.161



164.819



163.526



163.527



163.528



164.602



164.613



164.710



163.982



164.525

U.E.	DESCRIPCION	261	Ref. Adaptable
25	Fijac. revestimientos interiores LS430, RX300 (ver Mitsubishi, PSA, Subaru, Suzuki, Toyota)	163.161	90467-10161
25	Fijac. spoiler y protección lado puerta RX300 (ver Toyota)	163.162	90467-10162
25	Fijac. panel puerta y tapizados interiores LS400, RX300 '00->'03 (ver Suzuki, Toyota)	163.250	67771-12050
10	Fijac. moldura portón trasero IS200/300, GS300/430 (ver Toyota)	163.251	75819-12040
10	Fijac. moldura lateral puerta RX300 '00->'03 (ver Toyota)	163.526	75397-48030
10	Fijac. moldura lateral puerta RX300 '00->'03 (ver Toyota)	163.527	75395-33030
10	Fijac. moldura lateral puerta GS30/35/43/460, GS450H (ver Toyota)	163.528	62955-12010
10	Fijac. tapizados interiores IS250/350, IS F, GS30/35/43, GS450H, LS430, LS460, RX300/330/350, RX400H (ver Toyota)	163.621	90467-10167
10	Fijac. moldura inferior puerta LS400, LS430, GS300 (ver Toyota)	163.982	75867-30110
10	Fijac. tapizados interiores RX300/350/400H (ver Subaru, Toyota)	164.525	90950-08004
10	Fijac. tapizados maletero LX450 (ver Toyota)	164.602	76817-68010
10	Fijac. moldura lateral puerta LS460, LS600, RX350/450H (ver Toyota)	164.613	62955-50010
10	Fijac. moldura aleta RX450H '15-> (ver Toyota)	164.710	90467-08224
25	Fijac. moldura inferior parabrisas RX450H '15->, fijac. soporte aleta IS '13-> (ver Toyota)	164.819	90467-10204



164.020



163.259



163.193



163.258



163.356



164.188



163.160



163.165



164.091



164.822



164.189



164.099



163.249

U.E.	DESCRIPCION	261	Ref. Adaptable
10	Fijac. moldura pasoruada RX300 '00->'03 (ver Toyota)	163.160	53879-14010
25	Fijac. pasoruada RX270/350/450H, RX300, RX400H (ver PSA, Toyota)	163.165	90189-06013
25	Fijac. insonorizante capó IS200/300, LS400/430, RX300 '00->'03, SC430 (ver Toyota)	163.193	90467-08124
10	Fijac. moldura pasoruada LX470 (ver Toyota)	163.249	53879-60010
10	Fijac. aislamiento capó IS250/350, IS F, IS250C, GS30/35/43, GS300/450, LS430/460/600, LX470/570, GX460, RX300/350/400H/450H (ver PSA, Toyota)	163.258	90467-09050
25	Fijac. goma capó CT200H, IS250C, IS F, GS30/35/43, GS300/450, LS400/430/460/600, RX300/330/350/400450H (ver Toyota)	163.259	90467-08011
25	Fijac. tapizados asiestos LS430 '00->'06 (ver Toyota)	163.356	90467-05096
10	Fijac. rejilla parabrisas "torpedo" IS F '08->, IS 250/220 '05->, GS450H, LX470 '02->, LS460/600 (ver Toyota)	164.020	90467-08108
25	Fijac. varios usos IS220D/250, IS F, RX300 (ver Toyota)	164.091	90189-06157
25	Fijac. bajos carroceria IS F '07->, LS460, LS600H, LX570 (ver Toyota)	164.099	90467-07211
10	Fijac. parachoque IS250/220D '05, GS450H, LS430, LX570 (ver Toyota)	164.188	53879-58010
10	Fijac. parachoque IS F '07->, IS250/220D '05-> (ver Toyota)	164.189	90467-07146
10	Fijac. moldura aleta delantera RX450H '15-> (ver Toyota)	164.822	90467-07220



164.087



163.167



163.476



163.530



163.529



164.299



163.166



163.981



163.296



163.297



163.358



164.292

U.E.	DESCRIPCION	261	Ref. Adaptable
50	Fijac. parachoques IS200/300 '99->'05 (ver Nissan, PSA, Toyota)	163.166	90467-08185
50	Fij. mold. pasoruada IS200/300 '99->'05, IS250/350 '05, LS430, fij. bajos carrocería IS250C, GS300 (ver PSA, Toyota)	163.167	90467-07166
25	Fijac. parachoques LS400, SC430 (ver Toyota)	163.296	90467-09093
25	Fijac. tubo inyección gasolina IS200/300 (ver Toyota)	163.297	90467-09189
25	Fijac. parachoques y rejilla radiador IS250/350 '05->, IS250C '09->, IS F '08-> (ver PSA, Toyota)	163.358	52161-16010
25	Fijac. pasoruada SC430 '01-'10, y otros usos GX460 '10->, LX570 '07-> (ver Fiat, Honda, Suzuki, Toyota)	163.476	90467-07164
25	Fijac. moldura pasoruada GS30/35, GS450H, GX460, fijac. protector maletero RX300/350/400H (ver PSA, Toyota)	163.529	90467-07201
25	Fijac. bajos carrocería CT200H '10-> (ver Toyota)	163.530	90467-07183
10	Fijac. parachoques trasero LS400 (ver PSA, Toyota)	163.981	90467-09128
25	Fijac. rejilla calandra LFA, RX300, fijac. parachoque RX350/450 (ver Toyota)	164.087	90467-07117
25	Fijac. pasoruada IS F '07->, fij. bajos carrocería RX300/350 '03->, RX400H '05-> (ver Toyota)	164.292	51454-48010
25	Fijac. talonera puerta RX300/350 '03->, RX400H '05->, fijac. bajos carrocería LS600H '07-> (ver Toyota, Volvo)	164.299	90467-08180



164.611



163.507



163.803



163.472



164.183



164.289



163.531



163.473



164.825



164.795



164.794



164.234



164.708



164.793



154.235



164.458 - Dcho.
164.459 - Izdo.



164.460 - Dcho.
164.461 - Izdo.

U.E.	DESCRIPCION	261	Ref. Adaptable
10	Fijac. tapizados interiores Mazda 6, 626, Demio	163.472	GA2K-68-AB1
10	Fijac. tapizados interiores Mazda 323, 626, Premacy (Eurocode 5159ASCVB)	163.473	GA7B-50-797A
10	Fijac. moldura parabrisas Mazda 323, 929, Mercury Tracer, Truck (Eurocode 5117ASCS)	163.507	HA01-50-609 HA01-50-609A
10	Fijac. panel puerta - varios modelos - (ver Suzuki, Toyota)	163.531	9927-40-825
10	Fijac. moldura parabrisas Mazda Demio '98->'03 (Eurocode 5157ASCVB)	163.803	D201-50-797
25	Fijac. panel puerta Mazda 2, 323, 626, 929, MX-3, RX-7	164.183	G350-68-AB1
25	Fijac. talonera puerta Mazda 2, 3, 5, 6, CX-7 y CX-9	164.234	G18K-51-SJ3
10	Fijac. talonera puerta Mazda 2, 3, 5, 6, CX-7 y CX-9	164.235	BP4L-51-SJ3
25	Fijac. panel puerta Mazda 3, 5, 6 y CX-7	164.289	GJ6A-68-AB1 GJ6R-68-ABX
10	Fijac. rejilla parabrisas "torpedo" Mazda 2 (ver Ford)	164.611	DD10-50-891A
25	Fijac. moldura puerta Mazda CX-9 '16->	164.708	TD12-51-SJ3A
10	Fijac. moldura puerta Mazda CX-5 '12->	164.793	KD53-51-SJ3A
10	Fijac. moldura puerta y aleta Mazda CX-3 '15->	164.794	KD51-51-W24
10	Fijac. moldura aleta Mazda CX-3 '15->	164.795	KD53-51-W24
10	Fijac. moldura aleta Mazda CX-5 '12->	164.825	KD45-51-W24
1	Soporte cristal elevalunas delantero derecho Mazda 3, 5 y 6	164.458	
1	Soporte cristal elevalunas delantero izquierdo Mazda 3, 5 y 6	164.459	
1	Soporte cristal elevalunas trasero derecho Mazda 3, 5 y 6	164.460	
1	Soporte cristal elevalunas trasero izquierdo Mazda 3, 5 y 6	164.461	

Ø 7
Tornillo Ø 4,2



163.172

8 x 8
Tornillo Ø 5,5



163.275

8,5 x 8,5
Tornillo Ø 4,8



163.520

9 x 9
Tornillo Ø 4,2



163.619

Ø 4



164.233

Ø 4



164.812



163.521



163.522



164.414



163.159



164.799

U.E.	DESCRIPCION	261	Ref. Adaptable
25	Clip fijac. parrilla radiador - varios modelos - (ver Honda, Opel, Toyota)	163.159	
25	Fijac. varios usos Mazda 323, 626 Wagon (ver Honda)	163.172	9991-00-412
50	Fijación parachoque trasero, panel puerta y tapizados Mazda 2, 3, 5, 6, 121, 323, 626, Demio, MX3, MX5, RX8	163.275	9991-00-501
10	Fijac. tapizados interiores - varios - (ver Honda, Nissan, Toyota)	163.520	H001-50-841
50	Fijac. varios usos Mazda - varios modelos -	163.521	9926-40-426
50	Fijac. varios usos Mazda - varios modelos -	163.522	9926-40-543A
25	Fijac. aletas, pasoruada y cubre cárter - varios modelos - (ver Toyota)	163.619	
10	Fijac. parachoque Mazda 2, 3, 5, 6, 323, CX-5, CX-7, CX-9, Demio, 323 y 626	164.233	B455-56-135
25	Fijac. insonorizante capó Mazda 2, 3, 5, 6, CX-5, CX-7 y CX-9	164.414	TD11-56-694
10	Fijac. parrilla radiador Mazda 3, 6 y CX-5	164.799	G46L-50-EB1
10	Fijac. parachoque Mazda 2, 3, 5, 6, 323, CX-3, CX-5, CX-9	164.812	C274-50-133

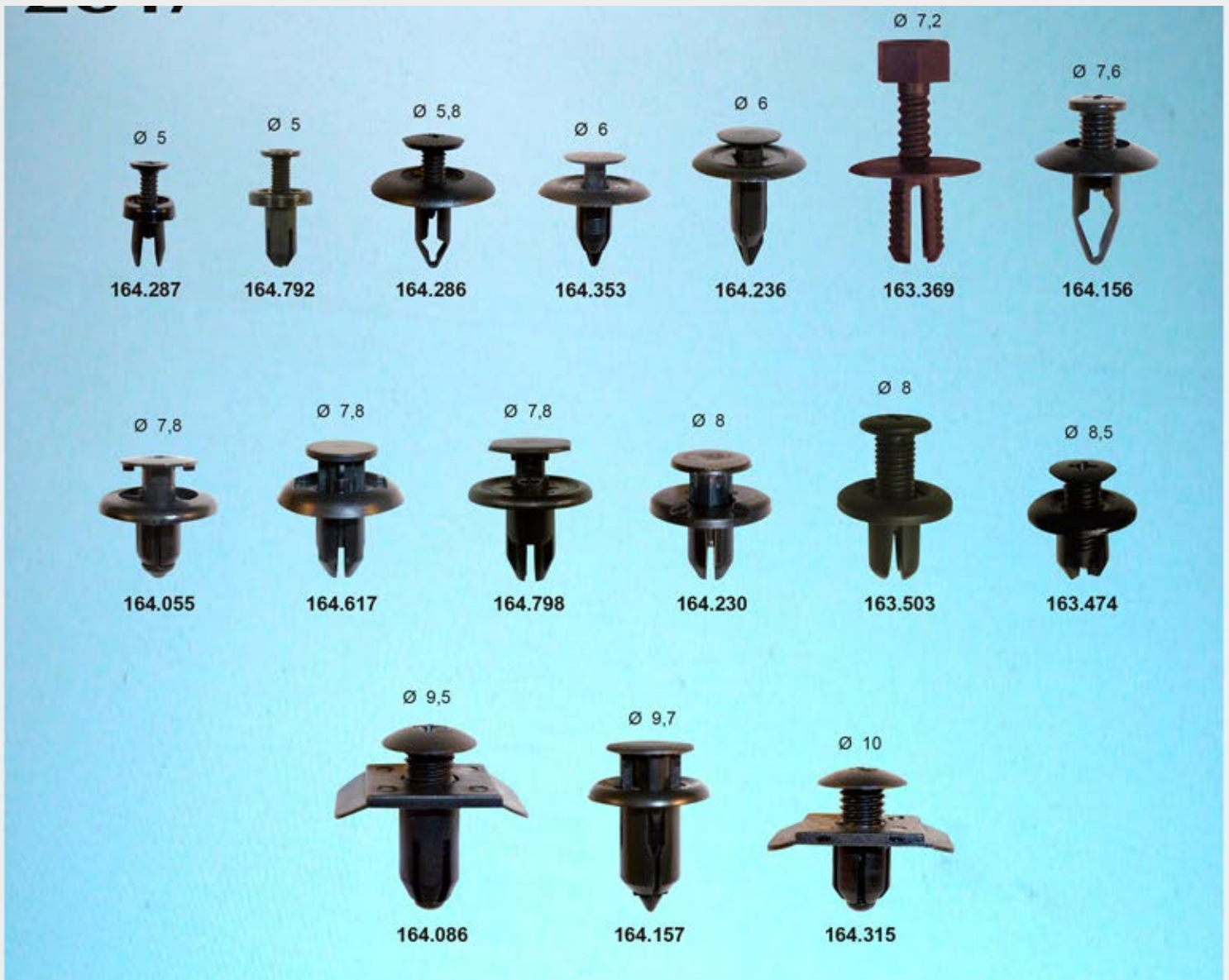

U.E.	DESCRIPCION	261	Ref. Adaptable
50	Fijac. rejilla parabrisas "torpedo" Mazda 2 (ver Ford)	163.369	9X706182X0
10	Remache roscado fijac. pasoruada y aletas Mazda 323, 626, Demio	163.474	B455-56-143
25	Fij. talonera puerta Mazda 6, pasoruada y parachoques - varios modelos- (ver Hyundai, Toyota)	163.503	9926-50-625 B092-51-833
25	Fijac. parachoque y pasoruada Mazda 2, 3 y 6, fij. rejilla parabrisas "torpedo" Mazda 2 '07-> y 3 (ver Ford)	164.055	BC1D-56-145
10	Fijac. parachoque trasero Mazda 3, 323 y MPV '02->, fij. parachoque delantero Mazda CX-9, MX-5	164.086	BF82-50-233
25	Fijac. pasoruada Mazda 3, 5, 6, 323 y CX-7	164.156	NA01-56-145
10	Fijac. parachoque Mazda 2, 3, 5, 6, 323, BT-50, CX-7, CX-9, fij. parrilla radiador Mazda 2 '09->, 6, 323, BT-50, CX-5	164.157	GD7A-50-EA1
10	Fijac. pasoruada Mazda 3 '14->, Mazda 6 '15->, fijac. "torpedo" parabrisas CX-9 '16-> (ver Nissan, Renault)	164.230	L33X-13-209
10	Fijac. tapizados interiores Mazda 3, 5, 6, 323, CX-9	164.236	B467-68-AC3
25	Fijac. rejilla parabrisas "torpedo" Mazda 5	164.286	C238-68-865
25	Fijac. rejilla parabrisas "torpedo" Mazda 5 (Eurocode 5173ASCHB)	164.287	GJ6E-50-715B
25	Fijac. parachoque Mazda 323, CX-9, MPV (ver Hyundai/Kia, Mitsubishi)	164.315	BF67-50-033
10	Fijac. moldura aleta Mazda 3 '14->, Mazda 6 '15->, CX-3, CX-5, fij. tapizados interiores CX-7	164.353	GJ21-68-885B02
25	Fijac. pasoruada Mazda 3, CX-3, fijac. parachoque Mazda 6, CX-3, CX-9	164.617	B45A-56-146A
25	Fijac. parrilla radiador Mazda 2, 3 y 6, MX-5	164.792	EA01-50-037
25	Fijac. parachoque y bajos carroceria Mazda 2, 3 y 6, CX-3, CX-5	164.798	BGV4-56-145

Ø 4,8 x 15
arandela Ø 15



161.473

Ø 4,8 x 18
arandela Ø 15



161.474

Ø 5,5 x 19
arandela Ø 22



161.742

Ø 6,3 x 19
arandela Ø 18



162.556

Ø 6,3 x 19
arandela Ø 22



161.743

Ø 2,9



161.487

Ø 2,9



161.757

Ø 4



161.414

Ø 4,2



161.492

Ø 4,2



161.493

Ø 4,8



161.498

Ø 4,8



161.702

U.E.	DESCRIPCION	261	Ref. Adaptable
100	Clip fijac. varios usos Mercedes - varios - (ver Ford)	161.414	A000 994 01 45
50	Tornillo Ø 4,8 x 15 (aro Ø 15), varios usos (ver varias marcas)	161.473	
50	Tornillo Ø 4,8 x 18 (aro Ø 15), varios usos (ver varias marcas)	161.474	A123 990 01 36
50	Clip fijac. varios usos Mercedes - varios -	161.487	A001 994 04 45 A123 994 01 45
50	Clip fijac. varios usos Mercedes - varios - (ver Ford)	161.492	A140 994 10 45
50	Clip fijac. varios usos Mercedes - varios - (ver BMW, Ford)	161.493	A000 994 25 45
50	Clip fijac. varios usos Mercedes - varios - (ver BMW, VAG)	161.498	A000 994 05 45
50	Clip fijac. varios usos Mercedes - varios modelos - (ver BMW)	161.702	A000 994 14 45
50	Tornillo Ø 5,5 x 19 (aro Ø 22), suj. guardabarros (ver varias marcas)	161.742	
50	Tornillo Ø 6,3 x 19 (aro Ø 22), suj. guardabarros (ver varias marcas)	161.743	A000 990 68 36
50	Clip fijac. tapa altavoces Mercedes - varios modelos -	161.757	A001 994 54 45 A000 994 42 45
50	Tornillo Ø 6,3 x 19 (aro Ø 18), sujeción guardabarros (ver BMW, Ford, Opel, VAG)	162.556	



161.748



161.749



161.703



161.813



161.746



161.747



161.812



161.825



161.826

U.E.	DESCRIPCION	261	Ref. Adaptable
50	Clip fijac. varios usos Mercedes - varios modelos - (ver Fod, Renault)	161.703	A003 994 42 45 A002 994 20 45
50	Clip fijac. rejillas frontales W124, W126 y varios	161.746	A000 994 47 45 A126 994 12 45
50	Clip fijac. revestimientos puerta Mercedes - varios modelos - (ver Ford)	161.747	A000 994 09 45
25	Clip fijac. protector cárter/motor Mercedes - varios modelos -	161.748	A004 994 31 45
25	Clip fijac. protector cárter/motor Mercedes - varios modelos -	161.749	A002 994 80 45
25	Clip fijac. protectos cárter/motor Mercedes clase A (W169), clase B (W245), clase C (W202, 203 y 204), clase E (W210 y 211) y ML	161.812	A004 994 18 45 A201 990 09 91
10	Clip fijac. parachoque clase A (W169), clase B (W245) y GL, fij. tapizados interiores clase E (W211)	161.813	A004 994 15 45
10	Clip fijac. tapizados interiores Vito (W638)	161.825	A638 695 00 09
10	Clip fijac. tapizados interiores Vito (W639)	161.826	A004 994 71 45



163.463



163.784



164.279



164.281



164.597



164.682



163.943



162.919



163.537



164.529



163.462



163.640



163.464



164.117

U.E.	DESCRIPCION	261	Ref. Adaptable
10	Fijac. moldura parabrisas izquierdo Vito (W638) Clase V (blanca) (Eurocode 5428ASCVS)	162.919	A638 984 08 61
10	Base parabrisas Clase E '02->'08 (W211) (Eurocode 5347ASCSSB)	163.462	A211 988 00 81
10	Fijac. moldura lateral parabrisas Clase A '05->'12 (W169), Clase B '05->'12 (W245)	163.463	A012 988 60 78
25	Fijac. rejilla parabrisas («torpedo») Clase A '05->' (W169), Clase B '05->' (W245) y fijac. moldura portón trasero Clase C '00->'07 (W203)	163.464	A008 988 73 78
10	Fijac. moldura parabrisas derecho Vito (W638) Clase V (negra) (Eurocode 5428ASCVR)	163.537	A638 984 09 61
25	Fijac. rejilla parabrisas («torpedo») Clase C '07->' (W204) (Eurocode 5364ASSSB) fijac. otros usos W123, W124, W126, W211, W219	163.640	A123 990 05 92 A126 990 03 92
10	Fijac. molduras parabrisas Vaneo '02->' (Eurocode 5436ASCVS)	163.784	A009 988 16 78
10	Fij. mold. techo-parabrisas Clase A '04->' (W169) y Clase B '05->' (W245) (Eurocode 5358ASCHDS)	163.943	A000 991 58 71
10	Fijac. moldura parabrisas Clase A '97->'12 (W168/169)	164.117	A009 988 67 78
10	Fijac. moldura parabrisas Clase C '00->'07 (W203)	164.279	A010 988 59 78
10	Fijac. moldura parabrisas Clase B '11->' (W246), Clase C '07->' (W204) y Clase E '09->' (W212)	164.281	A001 991 02 70
10	Fijac. moldura inferior parabrisas Clase C '14->' (W205) (Eurocode 5385ASCSS)	164.529	A205 991 00 98
10	Fijac. moldura lateral parabrisas Clase A '13->' (W176), GLA '13->' (X156)	164.597	A003 991 94 70
10	Fijac. moldura lateral parabrisas Clase C (W205) '15->'	164.682	A004 991 06 70



U.E.	DESCRIPCION	261	Ref. Adaptable
10	Fijac. moldura techo-parabrisas (190-202) (Eurocode 5328ASCST)	162.730	A201 698 01 60
10	Fijac. moldura techo-parabrisas (190-202) (Eurocode 5328ASCST1B)	162.731	A201 698 06 60
10	Fijac. moldura techo (190-202)	162.732	A201 698 02 60
10	Fijac. molduras superior parabrisas Clase E '95->'02 (W210) (Eurocode 5337ASCST)	163.461	A210 690 02 13
10	Fijac. molduras techo-parabrisas Clase C '00->'07 (W203) (Eurocode 5352ASCCD)	163.783	A203 690 00 13
10	Fijac. moldura techo-parabrisas Clase C '07-> (W204) (Eurocode 5364ASCSDS)	163.908	A204 690 06 14
10	Fijac. moldura techo-parabrisas Clase E '02->'08 (W211) (Eurocode 5347ASCS)	163.909	A011 988 94 78
25	Fijac. moldura techo ML '05-> (W164)	164.267	A164 698 00 60
10	Fijac. moldura techo CLK '02-> (W209)	164.276	A209 690 00 13
10	Fijac. moldura techo-parabrisas CLS '05-> (W219)	164.277	A219 690 04 14
10	Fijac. moldura techo-parabrisas Clase S '05-> (W221)	164.278	A000 991 78 98
10	Fijac. moldura techo Clase E '09-> (W212)	164.469	A212 991 00 98

164.534

164.535

164.410

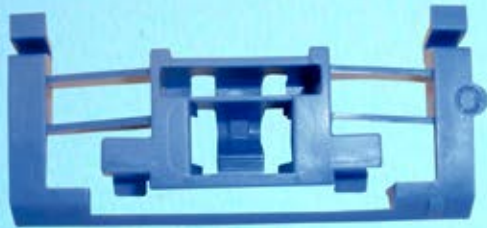
164.411

164.412

164.413

164.805

164.804

U.E.	DESCRIPCION	261	Ref. Adaptable
10	Fijac. moldura techo-parabrisas Clase A '13-> (W176) (Eurocode 5381ASCHDS)	164.410	A001 991 18 98
10	Fijac. moldura techo-parabrisas Clase A '13-> (W176) (Eurocode 5381ASCHDS1B)	164.411	A001 991 49 98
10	Fijac. moldura techo-parabrisas Clase A '13-> (W176) (Eurocode 5381ASCHS7B)	164.412	A001 991 50 98
10	Fijac. moldura techo-parabrisas Clase A '13-> (W176) (Eurocode 5381ASCHS8B)	164.413	A001 991 51 98
10	Fijac. moldura techo-parabrisas Clase B '11-> (W246) (Eurocode 5377ASCHDS1B)	164.534	A001 991 36 98
10	Fijac. moldura techo-parabrisas Clase B '11-> (W246) (Eurocode 5377ASCHDS)	164.535	A001 991 16 98
10	Fijac. moldura inferior derecha parabrisas Clase A '13-> (W176) (Eurocode 5381ASCHS6B)	164.804	A176 991 01 98
10	Fijac. moldura inferior izquierda parabrisas Clase A '13-> (W176) (Eurocode 5381ASCHS)	164.805	A176 991 00 98

2617



163.405



164.108



164.112



163.406



163.057



164.125



163.907



164.554



164.553



163.779



163.856



163.855

U.E.	DESCRIPCION	261	Ref. Adaptable
10	Fijac. varilla capó ML (ver Opel)	163.057	
10	Fijac. varios usos Mercedes	163.405	A601 078 20 41
50	Fijac. gomas puerta y capó Mercedes 300, 400, 500,600	163.406	A000 997 13 86
10	Fijac. talonera puerta Clase C (W203) y otros usos SLK (W170 / W171)	163.779	A009 997 72 81
1	Fijac. gato talonera puerta Clase C (W203) '00->'07	163.855	A203 997 01 86
1	Fijac. gato talonera puerta Clase E (W210) '95->'02 y Clase S (W220) '99->'05	163.856	A001 997 95 86
25	Fijac. parachoque Clase C (W203/W204), Clase E (W211) y W164	163.907	A002 988 51 81
50	Fijac. insonorizante capó Clase C (W204), Clase E (W212), Vito (W639)	164.108	A001 988 03 25
25	Fijac. altavoces Sprinter, Vito	164.112	A000 988 63 25
25	Fijac. varilla capó Clase C (W202/W203/W204), Clase E (W210/W211/W212), GL, ML, CLK, SLK	164.125	A000 995 01 48
10	Fijac. talonera puerta Clase C (W204) '07->	164.553	A000 991 73 98
10	Fijac. talonera puerta Clase C (W204) '07->	164.554	A000 991 74 98



163.550 - Dcho.
163.551 - Izdo.



164.595



164.496 - Dcho.
164.497 - Izdo.



163.659



164.492
Dcho. / Izdo.



164.494* - Dcho.
164.495* - Izdo.

* (imagen 1/2 tamaño real)

U.E.	DESCRIPCION	261	Ref. Adaptable
1	Kit soporte cristal elevalunas derecho Vito '03->'09	163.550	
1	Kit soporte cristal elevalunas izquierdo Vito '03->'09	163.551	
1	Soporte cristal elevalunas delantero derecho e izquierdo Mercedes Clase C (W203), S320	163.659	
1	Kit soporte cristal elevalunas delantero derecho e izquierdo Clase C (W204), Clase E (W212)	164.492	
1	Soporte cristal elevalunas derecho Vito '96->'03 (ver Nissan)	164.494	
1	Soporte cristal elevalunas izquierdo Vito '96->'03 (ver Nissan)	164.495	
1	Kit soporte cristal elevalunas derecho Vito '10->	164.496	
1	Kit soporte cristal elevalunas izquierdo Vito '10->	164.497	
5	Fijac. cristal elevalunas Clase C (W203) '00->'07	164.595	



162.738



162.913



163.284



164.128



163.418



162.746



163.857



163.417



163.788



163.419

U.E.	DESCRIPCION	261	Ref. Adaptable
10	Boca de fijación para perno moldura lateral (190-202)	162.738	A001 988 29 81 A001 988 49 81
25	Boca fijac. moldura (varios modelos)	162.746	A001 318 53 58 A000 988 15 81
25	Boca fijac. molduras -varios modelos-	162.913	A001 988 20 81
25	Boca fijac. molduras Mercedes 210	163.284	A001 988 76 81
25	Boca fijac. molduras (varios modelos) (ver Land Rover)	163.417	A202 988 04 81
25	Boca fijac. molduras Mercedes 202	163.418	A001 988 77 81
25	Boca fijac. molduras Mercedes 200, 230, 250, 300	163.419	A001 988 27 81
25	Boca fijac. tapizados puerta Vito	163.788	A631 997 23 86
25	Boca fijac. molduras laterales Mercedes -varios modelos-	163.857	A000 988 55 81
50	Fijac. anagrama Clase A, Clase B, Clase E (W212) '09->, GL, ML, CLK	164.128	A201 997 22 81

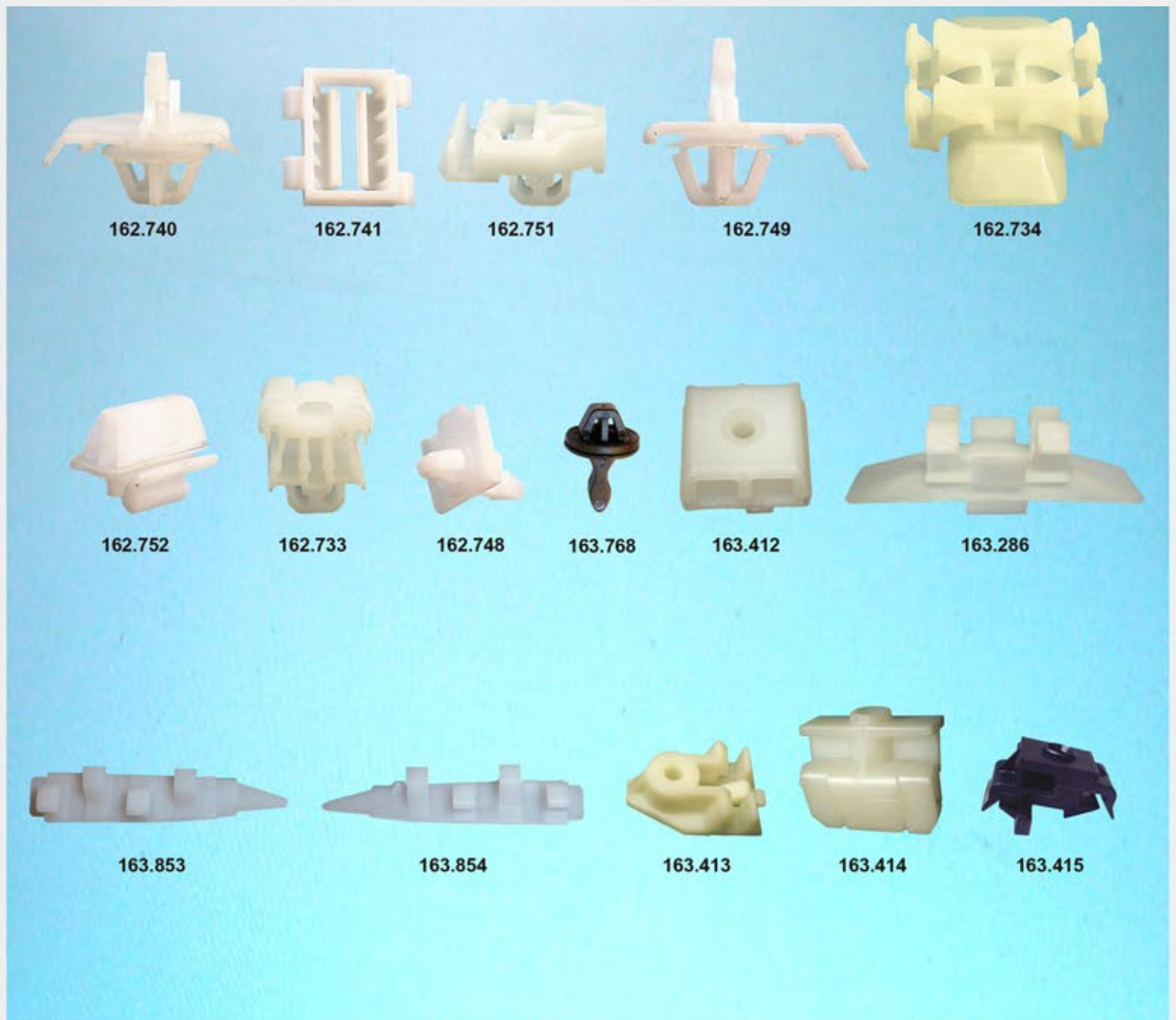

U.E.	DESCRIPCION	261	Ref. Adaptable
10	Fijac. moldura (124)	162.733	A124 988 04 78
10	Fijac. moldura puerta Clase C (W202, W203), Clase E (W211), Sprinter, Vito (W638/639)	162.734	A007 988 71 78
10	Fijac. moldura (190)	162.740	A001 988 63 81
10	Fijac. moldura (190)	162.741	A001 988 50 81
10	Fijac. moldura (124)	162.748	A001 988 49 81
10	Fijac. moldura (190)	162.749	A001 988 47 81
10	Fijac. moldura (190)	162.751	A006 988 35 78
10	Fijac. moldura (190-202)	162.752	A001 988 45 81
10	Fijac. moldura lateral (124)	163.286	A006 988 72 78
10	Fijac. moldura (124)	163.412	A124 990 00 52
10	Fijac. moldura lateral (190-201)	163.413	A002 994 64 45
10	Fijac. moldura lateral (190-201)	163.414	A002 994 65 45
10	Fijac. moldura lateral - varios -	163.415	A002 994 44 45
10	Fijac. moldura lateral portón trasero Vito (W638)	163.768	A638 690 00 13
10	Fijac. moldura lateral izquierda (parte trasera) 124, 200, 250, 300, 320	163.853	A006 988 75 78
10	Fijac. moldura lateral derecha (parte trasera) 124, 200, 250, 300, 320	163.854	A006 988 76 78



163.103



163.101



163.102



162.735



162.736



162.737



162.739



162.744



162.745



162.747



164.149



164.150



164.151



164.152

U.E.	DESCRIPCION		Ref. Adaptable
10	Fijac. moldura (190)	162.735	A001 988 60 81
10	Fijac. moldura (190)	162.736	A001 988 48 81
10	Fijac. moldura (190)	162.737	A001 988 46 81
10	Fijac. moldura (190)	162.739	A001 988 44 81
10	Fijac. moldura (190)	162.744	A006 988 30 78
10	Fijac. moldura (190)	162.745	A201 988 03 78
10	Fijac. moldura (190)	162.747	A001 988 51 81
10	Fijac. moldura lateral (parte derecha trasera) Clase C (W202)	163.101	A007 988 74 78
10	Fijac. moldura lateral (parte izquierda trasera) Clase C (W202)	163.102	A007 988 73 78
10	Fijac. moldura lateral (parte trasera) Clase C (W202) (monta junto con 163101 y 163102) (ver VAG)	163.103	A007 988 76 78
5	Fijac. moldura puerta (parte delantera) Clase E (W212) '09->	164.149	A001 991 00 71
5	Fijac. moldura puerta (parte delantera) Clase E (W212) '09->	164.150	A001 991 01 71
5	Fijac. moldura puerta (parte central) Clase E (W212) '09->	164.151	A001 991 02 71
5	Fijac. moldura puerta (parte trasera) Clase E (W212) '09->	164.152	A001 991 03 71

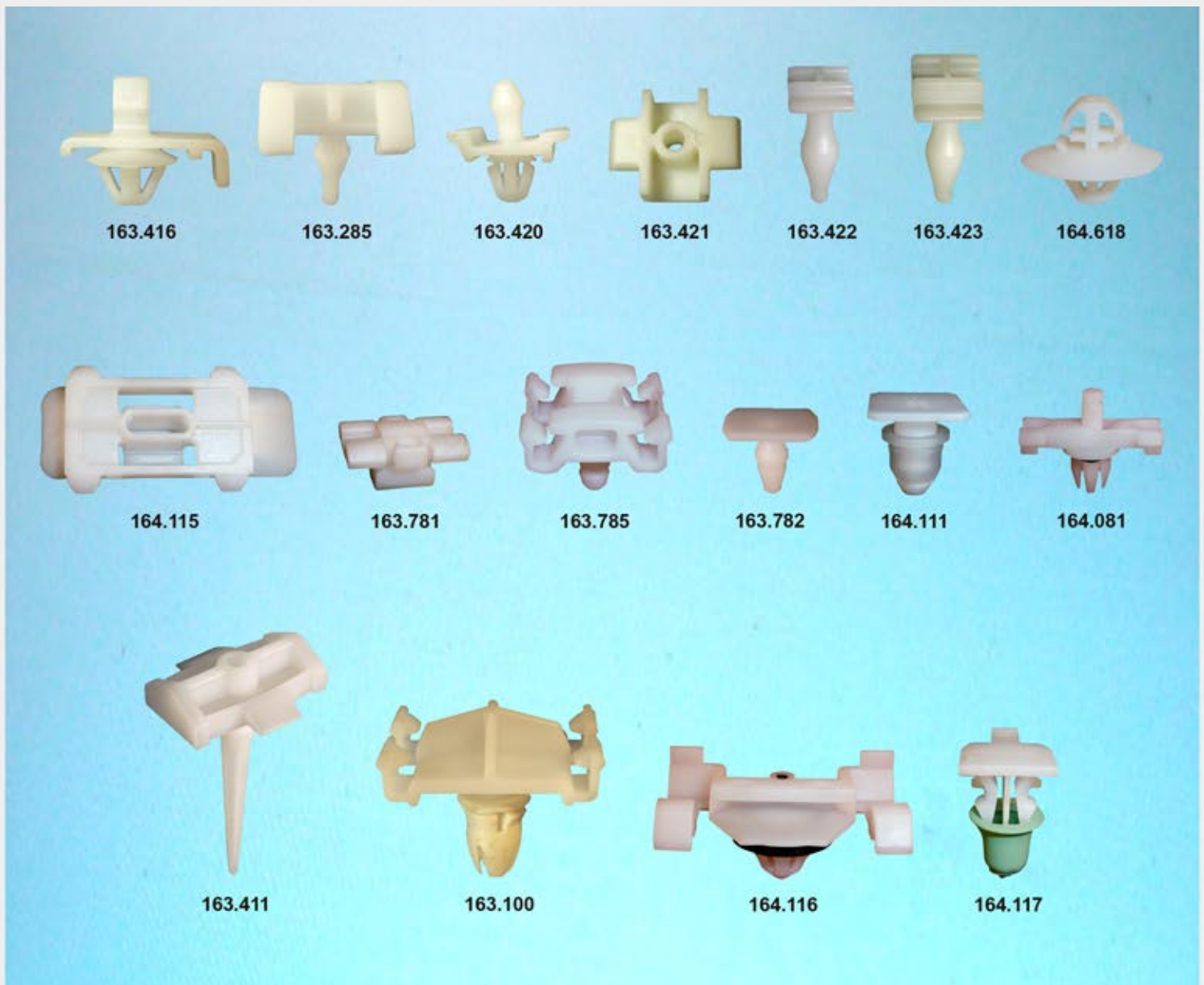

U.E.	DESCRIPCION	261	Ref. Adaptable
10	Fijac. moldura lateral (parte delantera) Clase C (W202, W208), Clase E (W210)	163.100	A001 988 80 81
10	Fijac. moldura lateral - varios -	163.285	A001 988 31 81
10	Fijac. moldura lateral - varios -	163.411	A001 988 36 81
10	Fijac. moldura lateral - varios -	163.416	A001 988 57 81
10	Fijac. moldura lateral 200, 220, 230, 300, 320	163.420	A001 988 32 81
10	Fijac. moldura lateral 200, 230, 250, 260, 300	163.421	A002 994 75 45
10	Fijac. moldura lateral 300, 400, 500, 600	163.422	A140 698 01 60
10	Fijac. moldura lateral 300, 400, 500, 600	163.423	A002 997 02 86
10	Fijac. moldura Clase C (W201)	163.781	A005 988 72 78
25	Fijac. parrilla radiador Clase C (W203), Clase E (W210)	163.782	A001 988 97 81
10	Fijac. moldura lateral Clase C (W203)	163.785	A011 988 28 78
10	Fijac. moldura techo Mercedes Vito (W639) (ver VAG)	164.081	A639 991 03 71
10	Fijac. moldura talonera puerta Clase E (W211) '02->'08	164.111	A001 997 65 35
10	Fijac. moldura puerta Clase C (W203) '00->'07, Clase E (W211) '02->'08, Vito (W639)	164.115	A009 988 95 78
10	Fijac. moldura inferior puerta Clase E (W211) '02->'08, Clase S	164.116	A211 988 05 78
10	Fijac. moldura pilar A Clase A (W168 y W169), fij. moldura pilar B Clase M (ML) '05->, GL '05->	164.117	A009 988 67 78
25	Fijac. moldura lateral puerta Sprinter '06->'13 (ver VAG)	164.618	A002 991 85 70 A001 991 83 70



U.E.	DESCRIPCION	261	Ref. Adaptable
50	Fijac. tapizados y panel puerta -varios modelos- (ver Ford)	162.953	
50	Fijac. panel puerta Mercedes (ver Seat)	163.282	A003 988 41 78
25	Fijac. tapizados interiores 240, 270, 320	163.407	A463 988 02 78
25	Fijac. tapizados puertas laterales y portón trasero Vito (W639), Sprinter	163.408	A000 991 27 71
50	Fijac. tapizados y panel puerta -varios modelos- (ver Mitsubishi)	163.649	A006 988 43 78
25	Fijac. tapizados portón trasero Vito (W638)	163.771	A638 988 09 78
50	Fijac. tapizados interiores laterales Sprinter, fij. tapizados traseros Clase S (W221) (ver BMW)	163.773	A006 988 57 78
25	Fijac. revestimientos interiores W124, W126, W140, W201, W202, W210	163.786	A001 988 10 81
50	Fijac. tapizados maletero Clase E (W210, W220, W221, W230)	163.789	A000 990 57 92
25	Fijac. panel puerta y revestimientos interiores Clase A (W169), Clase B (W245), Clase C (W204)	163.790	A000 991 04 98
25	Fijac. panel puerta Clase A (W176) '13->, Clase E (W212) '09->, ML, Vito '14-> fijac. tapizados interiores Clase C (W204), Vito '14->	163.791	A000 991 86 98
10	Fijac. panel puerta Mercedes ML (W163)	163.795	A163 988 16 78
25	Fijac. tapizados interiores Clase A (W169), Clase B (W245) (Eurocode 5358BSCH)	163.831	A000 991 24 98
10	Fijac. panel trasero techo Vito (W638)	163.833	A638 695 01 14 A638 695 01 09
50	Fijac. panel puerta -varios modelos- y camiones	163.861	A005 988 82 78
25	Fijac. panel puerta y tapizados interiores Clase C (W203), Clase E (W211), GL, ML (W164) (ver Smart, VAG)	164.027	A011 988 76 78
25	Fijac. panel puerta Clase C (W204), GL, ML (W164) '05->, fij. tapizados interiores Clase E (W212)	164.127	A000 991 01 98
25	Fijac. panel puerta Clase M (W164) '05->	164.560	A000 991 63 98
25	Fijac. panel puerta Clase C (W205) '14->	164.561	A001 991 26 98
25	Fijac. panel puerta Clase S (W222) '13->, fijac. tapizados interiores C207, C215, W221	164.632	A000 994 59 48
25	Fijac. tapizados maletero Clase E (W212) '09->'15, CLS, SL	164.713	A000 991 89 98
25	Fijac. panel superior parabrisas CLK (W209) '02->, C207 '10->, fijac. tapizados pilar A CLK (W208)	164.756	A000 990 85 92

2617



U.E.	DESCRIPCION	261	Ref. Adaptable
100	Fijac. molduras portón trasero Vito (W638) (ver Fiat, Ford, Seat, Renault)	162.238	A638 988 02 25
100	Fijac. tapizados puertas laterales y traseras Vito (W638) (ver PSA, Renault)	162.453	A638 984 13 61
50	Fijac. tapizados interiores - varios modelos -	162.753	A631 984 25 61
50	Fij. tapizados interiores Clase C (W202/W203/W204), Clase E (W210/211/212), Sprinter (ver VAG)	162.780	A000 997 46 86
50	Fijac. pasoruada, revestimientos y varios usos (ver VAG)	162.924	
100	Fijac. tapizados puerta y portón trasero Vito (W638) y tapizados interiores Vito (W639) (ver Nissan, PSA, Renault)	162.934	A638 984 16 61 A638 984 00 61
25	Fijac. rejilla lavaparabrisas "torpedo" Vito (W638), Clase V y otros modelos (ver BMW)	163.063	A638 994 08 45
25	Fijac. estribera bajo puerta Serie C 200	163.283	A000 988 52 25
50	Fijac. pasoruada Vito '14-> y otros usos - varios modelos -	163.287	A201 990 00 50
50	Fijac. pasoruadas, revestim. y otros usos - varios modelos - (ver BMW, Mini)	163.288	A003 990 02 51
25	Fijac. varios usos Mercedes	163.410	A000 988 44 25
25	Fijac. tapizados techo furgonetas Mercedes	163.424	A000 997 06 02
25	Fijac. tapizados interiores W124, W126, W140, W201, W202, W210	163.787	A001 988 09 81
50	Fijac. talonera y bajos carroceria varios modelos (ver Dacia, Fiat, Ford, Smart)	163.830	A002 990 53 50
50	Fijac. tapizados interiores Sprinter	164.109	A002 997 88 86
50	Fij. moldura aleta Clase C (W203), fij. otros usos Clase A (W169), Clase B (W245), Clase E (W211)	164.113	A002 997 33 86
50	Fijac. bajos carroceria Clase E (W212) '09->	164.119	A000 990 44 62
10	Fijac. varios usos Sprinter y Vito (W639)	164.120	A639 998 01 85 A000 998 42 25
25	Fijac. parachoque trasero Clase B (W245), ML '11->, y fijac. tapizados interiores Clase C (W203) (ver Smart)	164.124	A000 998 25 85
50	Fijac. recubrimiento capó Clase B (W246) '11->, fijac. soporte radiador Clase M (W164) '05->	164.705	A000 991 28 95

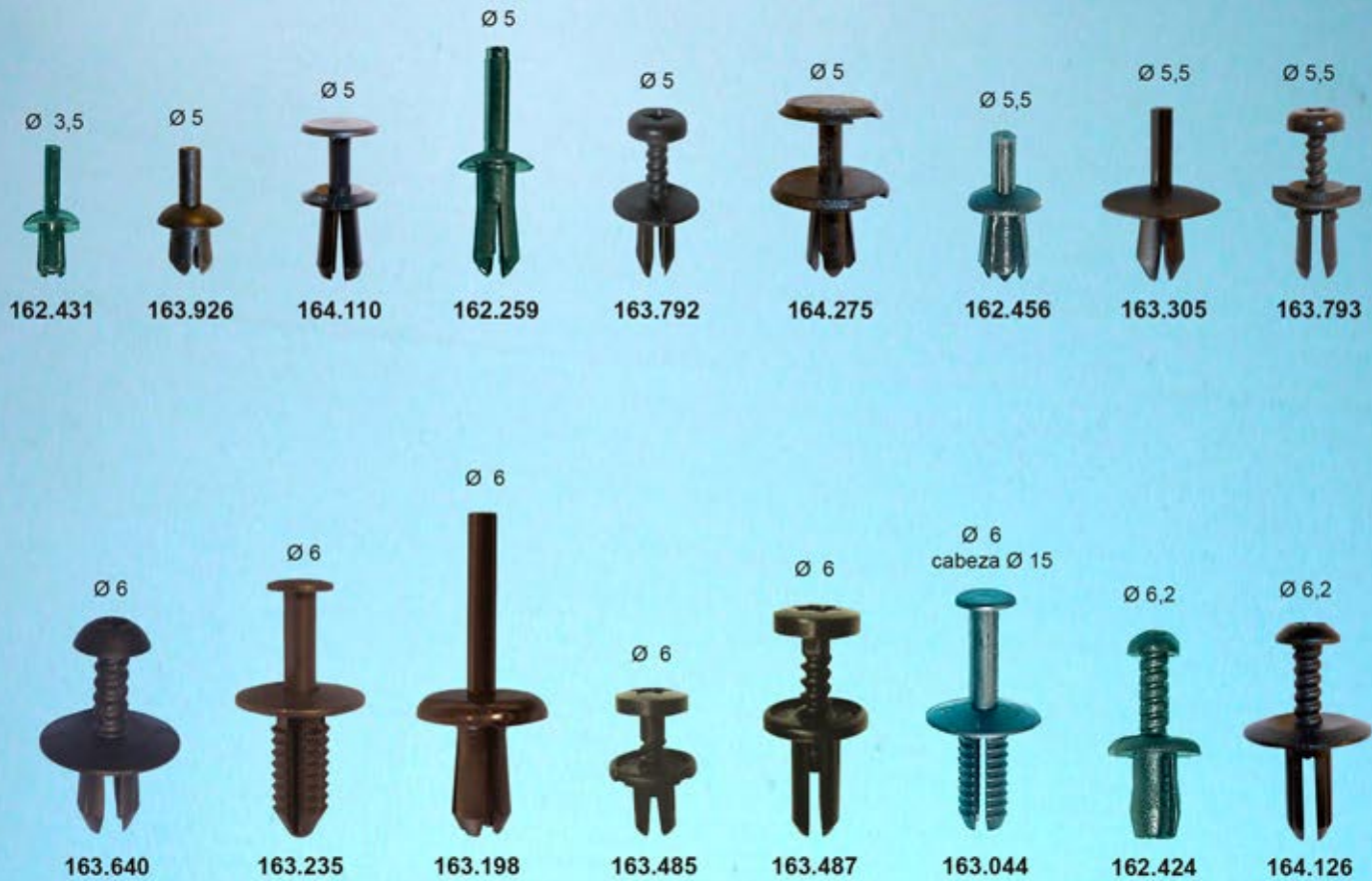

U.E.	DESCRIPCION	261	Ref. Adaptable
100	Remache fijac. varios usos Mercedes (ver Renault)	162.259	A638 984 02 61
50	Remache fijac. aletas y parachoques delantero y trasero Vito (W638), fijac. tapizados puerta lateral trasera y portón trasero Vito (W639) y otros usos -varios modelos- (ver Fiat, PSA, Renault, VAG)	162.424	A638 990 04 92
100	Remache fijac. varios usos y modelos (ver BMW, Opel, PSA, VAG)	162.431	A001 990 24 92
50	Remache fijac. varios usos y modelos (ver BMW, PSA, Renault, VAG)	162.456	A000 990 34 92
50	Fijac. pasorueta Sprinter '06 y otros usos clase C (W203), clase E (W211) (ver BMW, Land Rover, Mini, Smart, VAG)	163.044	A000 990 54 92
25	Remache fijac. varios usos Mercedes (ver Opel, Volvo)	163.198	A000 990 45 29
50	Remache fij. pasorueta clase C (W204/205), CLK (W209), clase E (W212), ML (W164), Vito '14-> fij. parachoque clase A (W169), clase B (W245), fij. talonera puerta clase C (W205), ML, GL, W164 fijac. bajos carroceria Vito '14-> (ver Opel, VAG)	163.235	A124 990 04 92
50	Remache fijac. varios usos Mercedes (ver Opel, VAG, Volvo)	163.305	A000 990 55 92
50	Remache fijac. varios usos clase B (W245), Vito (W638 y W639) (ver PSA, Smart, VAG)	163.485	A000 991 66 40
50	Remache fijac. parachoques delantero Vito (W638/639) (ver PSA, Renault)	163.487	A638 990 15 92
25	Remache fijac. rejilla parabrisas («torpedo») Clase C '07-> (W204) (Eurocode 5364ASSSB) fijac. otros usos W123, W124, W126, W211, W219	163.640	A123 990 05 92 A126 990 03 92
50	Remache fijac. rejilla calandra Clase C (W201), Clase S (W221), fijac. cristal posterior CLK (W209), fij. moldura portón trasero W124	163.792	A124 990 05 92 A124 990 90 51
50	Remache fijac. soporte radiador y otros usos -varios modelos-	163.793	A000 990 44 92
50	Remache fijac. panel puerta, tapizados interiores y otros usos -varios modelos- (ver Opel, Renault, Volvo)	163.926	A000 990 22 92
25	Remache fijac. aletas Clase E (W211) '02->'08	164.110	A140 990 05 92
25	Remache fijac. moldura inferior puerta SLK, fij. radiador CL500 y Clase S, y otros usos	164.126	A000 990 46 92
25	Remache fijac. panel puerta Clase A (W168), fij. rejilla parabrisas «torpedo» Clase C (W203)	164.275	A000 991 92 40 A001 990 13 92

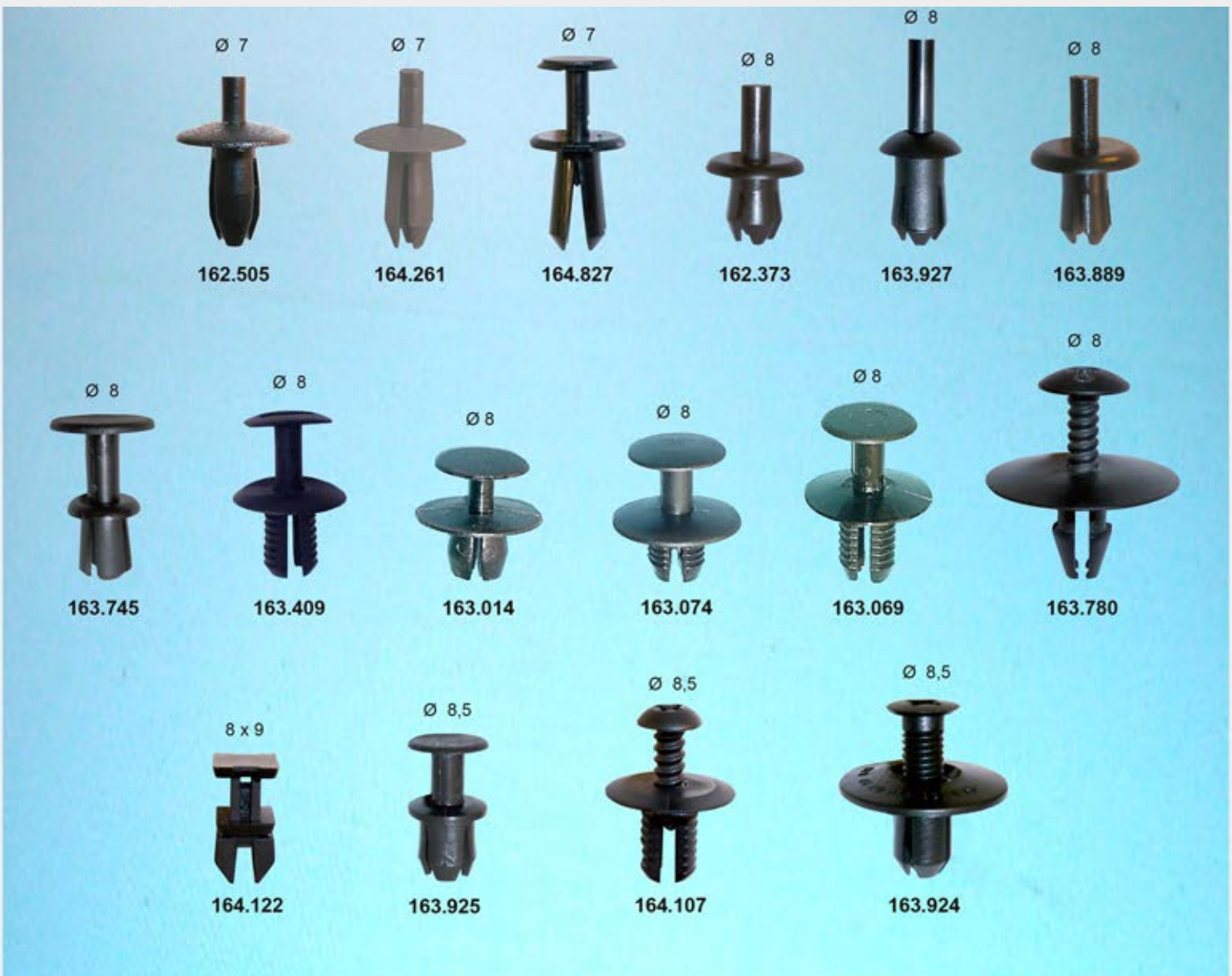

U.E.	DESCRIPCION	261	Ref. Adaptable
100	Remache varios usos Mercedes (ver Ford, Opel, PSA, VAG)	162.373	A000 990 29 92
50	Remache fijac. revestimientos interiores Mercedes (ver VAG)	162.505	
50	Fijac. rejilla lavaparabrisas "torpedo" Vito (W639) y otros usos Mercedes CL, SL (ver PSA, VAG)	163.014	A123 990 02 92
25	Remache fijac. parachoques trasero Vito (W639), fijac. moldura lateral parte posterior Sprinter, fijac. tapizados interiores clase C (W203), Vito '14->, otros usos CLK, ML, Clase S (ver BMW, Mini, Mitsubishi, VAG, Volvo)	163.069	A201 990 02 92
25	Remache fijac. tapizados interiores clase E (W212), y otros usos varios modelos (ver VAG)	163.074	A230 990 01 92 A000 990 78 92
50	Remache fijac. tapizados interiores Sprinter, Vito '14-> (ver VAG)	163.409	A000 991 39 40
25	Remache fijac. parachoque ML '11-> (ver BMW, VAG)	163.745	A000 991 72 40
25	Remache fijac. moldura talonera Clase C (W203), Clase E (W211), Clase s (W220)	163.780	A001 990 01 92
50	Remache fijac. varios usos Clase C (W202), Clase M (W163) (ver Opel)	163.889	A001 990 16 92
25	Remache fijac. protectores bajos ML (W163/W164) GL, CL, Clase S y R (W221/W251) (ver VAG)	163.924	A163 990 02 92
50	Remache fijac. soporte radiador y otros usos -varios modelos-	163.925	A123 990 00 92
50	Remache fijac. panel puerta, tapizados interiores y otros usos -varios modelos-	163.927	A000 990 37 92
25	Remache fijac. pasoruada y aleta delantera Vito (W639)	164.107	A000 990 48 92
50	Remache fijac. tapizados maletero Clase B (W245), Clase C (W202 y 203), Clase E (W210 y 211)	164.122	A124 990 07 92
50	Remache fijac. revestimientos interiores Mercedes (ver VAG)	164.261	A001 994 41 45
25	Remache fijac. rejilla parabrisas "torpedo", parachoques y parrilla radiador Vito '14->, fijac. bajos carroceria Clase A (W176) '13->, Clase B (W246) '11->	164.827	A000 991 94 40

Ø 4,8 x 15
arandela Ø 15



161.832



161.715



161.772



161.794



161.806



161.774



161.783



161.785



164.449

Dcho. / Izdo.

U.E.	DESCRIPCION	261	Ref. Adaptable
10	Tornillo fijación protector compartimento motor R50, R52, R53 (ver BMW)	161.715	51 71 8 212 148
10	Tuerca fijación insonorizante motor R50, R53 (ver BMW, VAG)	161.772	51 71 8 212 164 07 14 6 981 767
50	Fijación varios usos R50, R52, R53, R55, R56, R57, R60 (ver BMW)	161.774	07 12 9 901 746 07 12 9 925 770
50	Fijación revestimientos puertas R55, R56, R57, R58 y R59 (ver BMW)	161.783	51 41 2 756 212
25	Fijación embellecedor parachoques trasero Mini Countryman R60 (ver BMW, Ford)	161.785	07 14 7 054 461
10	Tuerca fijación parachoques R50, R52, R53, R56, R57, R58 y R59	161.794	07 13 1 502 288
50	Clip fijación varios usos Countryman R60, Paceman R61 (ver BMW)	161.806	07 14 7 154 447
25	Tornillo Ø 4,8 x 15 (aro Ø 15), fij. bajos carrocería R50, R52, R53, R56, R57, R58 y R59 (ver BMW)	161.832	07 11 9 901 299
1	Kit soporte cristal elevalunas delantero Mini Cooper '01->'06	164.449	



163.651



163.652



163.653



163.758



163.759



163.636



163.836



163.750



164.036



164.039



164.139



164.140

U.E.	DESCRIPCION	261	Ref. Adaptable
25	Fijac. moldura lateral parabrisas R52, R60 Countryman, R61 Paceman, F56 '14->	163.636	51 13 7 127 001
25	Fijac. moldura inferior parabrisas R50, R52, R53 (Eurocode 2440ASCHB)	163.651	07 13 1 490 537
25	Fijac. moldura inferior parabrisas R50, R52, R53 (Eurocode 2440ASCHB1B)	163.652	51 31 7 046 633
25	Fijac. moldura inferior parabrisas R50, R52, R53 (Eurocode 2440ASCHB2B)	163.653	51 31 7 111 933
25	Fijac. moldura parabrisas R58 (Eurocode 2466ASCCS6B) (ver BMW)	163.750	51 41 8 224 768
10	Fijac. moldura cristal lateral trasero R50, R53	163.758	51 36 7 044 616
10	Fijac. moldura cristal lateral trasero R50, R53	163.759	51 36 7 044 615
25	Fijac. moldura lateral techo (parte delantera) R50, R53, 55 (Eurocode 2455ASCHD)	163.836	51 13 7 058 122
25	Fijac. moldura lateral parabrisas Countryman (R60), Paceman (R61)	164.036	51 77 7 171 002
50	Fijac. moldura lateral parabrisas R55, R56, R57, R58, R59 y F56 '14-> (Eurocode 2466ASCCS) (ver BMW)	164.039	07 14 6 962 771
10	Fijac. moldura techo R55, R56	164.139	51 13 2 754 026
10	Fijac. moldura techo R56	164.140	51 13 2 754 319



163.651



163.652



163.653



163.758



163.759



163.636



163.836



163.750



164.036



164.039



164.139



164.140

U.E.	DESCRIPCION	261	Ref. Adaptable
25	Fijac. moldura lateral parabrisas R52, R60 Countryman, R61 Paceman, F56 '14->	163.636	51 13 7 127 001
25	Fijac. moldura inferior parabrisas R50, R52, R53 (Eurocode 2440ASCHB)	163.651	07 13 1 490 537
25	Fijac. moldura inferior parabrisas R50, R52, R53 (Eurocode 2440ASCHB1B)	163.652	51 31 7 046 633
25	Fijac. moldura inferior parabrisas R50, R52, R53 (Eurocode 2440ASCHB2B)	163.653	51 31 7 111 933
25	Fijac. moldura parabrisas R58 (Eurocode 2466ASCCS6B) (ver BMW)	163.750	51 41 8 224 768
10	Fijac. moldura cristal lateral trasero R50, R53	163.758	51 36 7 044 616
10	Fijac. moldura cristal lateral trasero R50, R53	163.759	51 36 7 044 615
25	Fijac. moldura lateral techo (parte delantera) R50, R53, 55 (Eurocode 2455ASCHD)	163.836	51 13 7 058 122
25	Fijac. moldura lateral parabrisas Countryman (R60), Paceman (R61)	164.036	51 77 7 171 002
50	Fijac. moldura lateral parabrisas R55, R56, R57, R58, R59 y F56 '14-> (Eurocode 2466ASCCS) (ver BMW)	164.039	07 14 6 962 771
10	Fijac. moldura techo R55, R56	164.139	51 13 2 754 026
10	Fijac. moldura techo R56	164.140	51 13 2 754 319



U.E.	DESCRIPCION	261	Ref. Adaptable
25	Fijac. moldura aletines pasoruada y parachoques R50, R52, R53, R56 y R57 ->08/'10	163.623	07 13 1 480 418
25	Fijac. moldura pasoruada delantero R50, R52 y R53	163.624	07 13 7 036 160
10	Fijac. moldura aleta pasoruada trasero R50, R52 y R53	163.625	51 13 7 034 022
10	Fijac. moldura pasoruada a capó R50, R52 y R53	163.626	07 13 7 036 159
25	Fijac. moldura talonera puerta R50, R53 y R56	163.627	07 13 7 073 915
25	Fijac. moldura talonera puerta R50, R52, R53, R56 y F56 '14->	163.628	07 13 1 480 419
50	Fijac. moldura talonera puerta R50, R52, R53 y R56	163.629	51 71 1 496 621
10	Fijac. agarradero exterior portón trasero R56 / R57 (ver BMW)	163.823	51 25 2 753 575
25	Fijac. moldura exterior pilar B Mini Countryman R60 (ver BMW)	163.826	51 33 7 140 714
50	Fijac. moldura ventana puertas R50, R52, R53 y R55	163.845	07 13 0 561 277
25	Fijac. moldura pasoruada trasero R50, R52 y R53	163.846	07 13 0 702 516
25	Fijac. moldura aletines pasoruada y parachoques Mini Cooper Cabrio R57 08/'10->	163.860	07 13 2 757 821
25	Fijac. moldura adorno frontal capó R55, R56 y R57	163.864	51 13 2 754 667

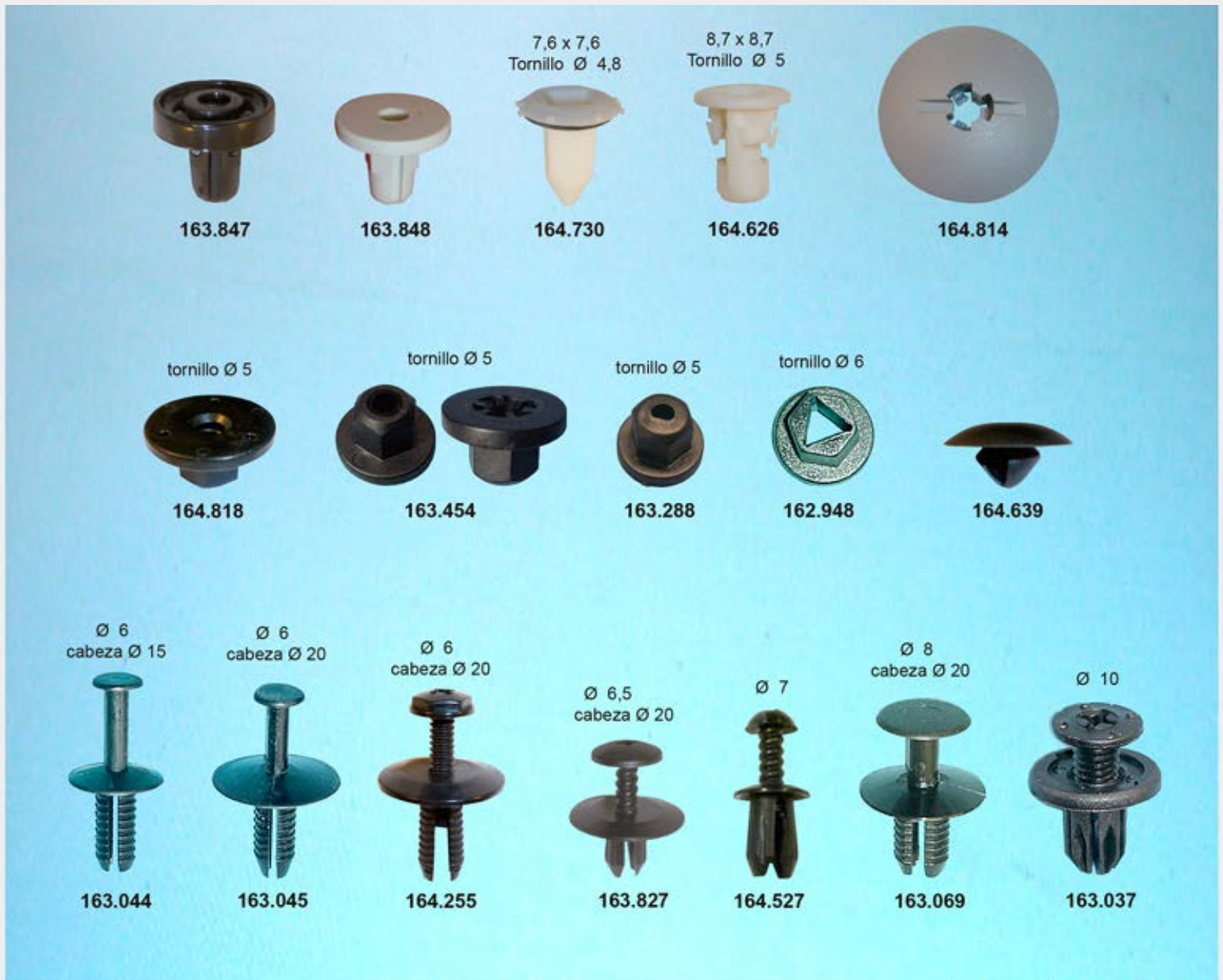

U.E.	DESCRIPCION	261	Ref. Adaptable
50	Fijac. parachoques trasero y revestimientos int. R50, R52, R53 y R56 (ver BMW, Ford, Opel, VAG)	162.948	
50	Fijac. pasoruada y talonera puerta R50, R52, R53, R55, R56, R57 y R60 (ver BMW, Chevrolet, Honda, Rover)	163.037	07 13 0 702 966
50	Fijac. revest. interiores R50, R52, R53 y R56 (ver BMW, Land Rover, Mercedes, Smart, VAG)	163.044	51 11 1 908 077
50	Fijac. revest. interiores R50, R52, R53 y R56, fijac. talonera puerta R55, R57 (ver BMW, VAG)	163.045	51 11 8 174 185
25	Fijac. parachoques delantero R56 (ver BMW, Mercedes, Mitsubishi, VAG, Volvo)	163.069	51 47 1 911 992
50	Fijac. parachoques trasero R50, R52, R53 y R56 (ver BMW, Mercedes)	163.288	16 13 1 176 747
50	Fijac. pasoruadas R56 (ver BMW)	163.454	51 16 1 943 122
50	Fijac. insonorizante motor R50, R52, R53, R55, R56, R60 y R61 (ver BMW)	163.827	51 48 1 915 964
25	Fijac. soporte matrícula trasero R50, R52 y R53	163.847	51 18 8 242 692
25	Fijac. soporte matrícula trasero R50, R52, R53, R56, y R57 (ver BMW)	163.848	51 18 8 242 693
25	Fijac. tapizados maletero R52 (ver BMW)	164.255	51 71 8 259 788
50	Fijac. parachoque trasero R56, R57, R59, fijac. soporte capo R55, R56, R57, R58, R59, R60, R61 (ver BMW)	164.527	51 16 8 197 908
25	Fijac. pasoruada y otros usos F54, F55, F56, F57, F60 (ver BMW)	164.626	07 14 7 201 307
50	Fijac. insonorizante motor F54, F55, F56, F57, F60 (ver BMW)	164.639	51 48 9 119 216
25	Fijac. soporte parachoque trasero R60, R61, fijac. spoiler trasero F55, F56 (ver BMW)	164.730	51 12 7 046 911
25	Fijac. insonorizante motor F55, F56, F57 (ver BMW)	164.814	51 48 8 126 849
50	Fijac. pasoruada, parachoque y bajos carroceria F54, F55, F56, F57, F60, R60, R61 (ver BMW)	164.818	07 14 7 169 847



U.E.	DESCRIPCION	261	Ref. Adaptable
10	Fijac. moldura parabrisas Montero, Pajero	163.273	MB-313984
10	Fijac. moldura parabrisas Carisma '95->'03, Space Star '98->'04 (ver Volvo)	163.643	MR-447362
50	Fijac. moldura parabrisas Space Star, fij. panel puerta Carisma '95->'03, Colt '04-> (ver Mercedes)	163.649	M-283083 MU-010571
10	Fijac. moldura parabrisas Colt '92->'02, Lancer '91->'00, Mirage (Eurocode 5641ASCHS)	163.832	MB-814154
10	Fijac. moldura parabrisas Colt '92->'02, Lancer '91->'00, Mirage (Eurocode 5642ASCHS)	163.977	MB-814152
10	Fijac. moldura parabrisas Colt '04-> (Eurocode 5670ASCH1 / 5672ASCH1)	164.173	7403A090
10	Fijac. moldura parabrisas Colt '04-> (Eurocode 5676ASCH1 / 5676ASCHDS1B)	164.174	7403A087
10	Fijac. moldura parabrisas Montero / Pajero ->'06, Lancer '00-> (Eurocode 5637ASCR)	164.201	MB-880455
10	Fijac. moldura parabrisas (lado izquierdo) Montero / Pajero '00->'06 (Eurocode 5660ASCR1)	164.202	MR-447883
10	Fijac. moldura parabrisas (lado derecho) Montero / Pajero '00->'06 (Eurocode 5660ASCR2)	164.203	MR-447884
10	Fijac. rejilla parabrisas "torpedo" Montero / Pajero '00->'06 (Eurocode 5660ASCR)	164.240	MR-155309
10	Fijac. moldura techo - parabrisas Lancer '00-> (Eurocode 5665ASCSS1B)	164.309	7403A020
25	Fijac. rejilla parabrisas "torpedo" ASX '10->, Lancer '00->, L200 '05->, Montero / Pajero Sport '08->, Outlander '06->	164.310	MR-777365
10	Fijac. moldura parabrisas (parte superior) Galant ->'03, Space Runner ->'02, Space Wagon '98->'04, fijac. luneta trasera Galant, Grandis '04->, Montero / Pajero '00 y '06-> (Eurocode 5689ASCRT)	164.408	MR-135939
10	Fijac. moldura parabrisas (parte superior) Lancer '00 y '07->, L200 '05->, Montero / Pajero '08->, Outlander '03->'08 y '08-> (Eurocode 5670ASSS)	164.409	MR-520530

2617



164.395



163.161



164.606



164.788



164.199



164.237



164.222



163.272



164.197



164.198



164.200



164.758



164.306



164.439

10 x 10
Tornillo Ø 4,8



163.538

10 x 10
Tornillo Ø 5,5



163.274

8,1 x 8,5
Tornillo Ø 6



164.352

8,5 x 8,5
Tornillo Ø 5,5



163.268

Tornillo Ø 5,5



163.539

Tornillo Ø 8



164.238

U.E.	DESCRIPCION	261	Ref. Adaptable
25	Fijac. panel puerta y tapizados interiores ASX, Colt, Montero/Pajero '06->, Outlander, Space Star (ver Lexus, PSA, Subaru, Suzuki, Toyota)	163.161	MU-000504
10	Taco fijac. tapizados y varios usos Mitsubishi - varios - (ver Nissan)	163.268	MU-480033
10	Fijac. tapizados Carisma, Colt Lancer, Space Runner	163.272	MB-344789
50	Taco fijac. tapizados Mitsubishi - varios -	163.274	M-293328
50	Taco fijac. tapizados Mitsubishi - varios -	163.538	MS-480002
10	Fijac. moldura pasoruada Mitsubishi - varios -	163.539	MB-138567
10	Fijac. moldura puerta Lancer '00, fijac. moldura aleta Montero / Pajero '00->'06, Outlander '03->'08	164.197	MR-533108
10	Fijac. moldura puerta Outlander '03->'08	164.198	MR-574773
10	Fijac. moldura talonera puerta Grandis '04, Outlander '06, Montero / Pajero '00 y '06->, fijac. panel puerta ASX '10->	164.199	MU-000588
10	Fijac. moldura puerta Colt ->'95, Galant ->'02	164.200	MB-361578
10	Fijac. moldura puerta Montero / Pajero '00->'06	164.222	MB-846992
25	Fijac. moldura talonera puerta Galant 96->'03, Montero / Pajero '00->'06, Space Wagon '98->'04	164.237	MR-435918
10	Fijac. parachoques Colt, Galant ->'03, Lancer, Outlander '03->'08, Space Runner ->'99	164.238	MR-271999
25	Fijac. rejilla radiador Montero / Pajero '00->'06, Space Gear / L400	164.306	MB-880530
10	Fijac. parachoques Galant '06->, Grandis '04->, Lancer '00 y '07->, Outlander '03->'08 y '08->, Montero / Pajero '06->	164.352	MR-393386
25	Fijac. panel puerta L200 '05->, fijac. rejilla radiador Montero / Pajero '06-> (ver Toyota) fijac. tapizados interiores Colt '05->, Galant '06->, L200 '05	164.395	MU-000637
50	Fijac. rejilla parabrisas "torpedo" Colt '95->'03, fij. moldura talonera puerta Montero/Pajero '90->'04, fijac. tapizados interiores Carisma, Galant ->'03, Montero/Pajero '90->'04	164.439	MB-566720
25	Fijac. moldura puerta Montero / Pajero '00->'06	164.606	MU-000573
25	Fijac. moldura puerta Colt, Lancer, Montero / Pajero '00->'06	164.758	MB-851006
10	Fijac. pasoruada L200 '05->'15	164.788	MU-000977



U.E.	DESCRIPCION	261	Ref. Adaptable
25	Fijac. varios usos y modelos (ver BMW, Mercedes, Mini, VAG, Volvo)	163.069	M-820141
25	Fijac. parachoque y pasoruada ASX '10, Grandis, Lancer, L200, Outlander '06, Montero/Pajero '06 (ver Ford, Honda,)	163.171	MU-000319
10	Fijac. moldura pasoruada Pajero, Montero	163.267	MB-115492
25	Fijac. parachoques, moldura pasoruada y tapizados Carisma, Colt, Galant, Outlander, Space Runner	163.269	MB-253964
25	Fijac. parrilla radiador y moldura pasoruada Carisma '95->'03, Colt '04->, Space Star '98->'04	163.270	MR-215510
25	Fijac. parrilla radiador, moldura pasoruada, parachoques Colt, Lancer, Montero, Outlander, Pajero	163.271	MR-288150
25	Fijac. varios usos y modelos Mitsubishi (ver PSA, Subaru, Suzuki, Toyota, Volvo)	163.300	MB-476821
25	Fijación pasoruada Montero, fijación rejilla radiador Montero/Pajero, fijación parachoques Galant, Space Runner (ver Honda, Nissan)	163.482	MR-328954
25	Fijac. parachoque Colt, Lancer, Montero/Pajero '06->, Outlander	164.085	MR-200300
10	Fijac. insonorizante motor ASX '10->, Grandis '04->, L200 '05->, Lancer, Montero / Pajero '06->, Outlander '03 y '08 (ver PSA)	164.239	MU-001282
25	Fijac. junta capó ASX '10->, Grandis '04->, Lancer '00 y '07->, Outlander, Montero / Pajero '08->, fijac. rejilla radiador L200 '05->, Montero / Pajero '08->	164.307	MU-487004
25	Fijac. junta capó ASX '10, Colt '91->'03, Galant '06, Grandis, L200 '96->'07, Lancer '92->'00 y '07->, Montero / Pajero '00 y '06->, Outlander '03 y '08->, Space Runner, Space Wagon	164.308	MU-481027
25	Fijac. panel puerta Galant '92->'96 (ver Hyundai/Kia, Mazda)	164.315	MR-114963
50	Fijac. junta puerta Lancer '04->, Outlander '07-> (ver PSA)	164.732	MU-000255
50	Fijac. pasoruada, parachoques y bajos carroceria ASX, Colt, Galant, Lancer '16->, Outlander '12->	164.760	MU-488006

261/

**164.498 - Dcho.
164.499 - Izdo.**

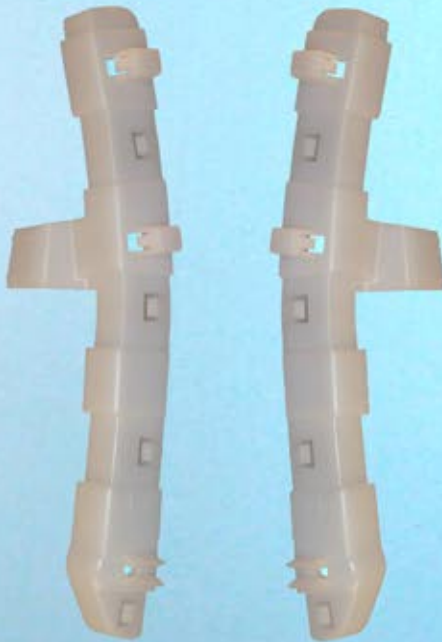
**164.494 - Dcho.
164.495 - Izdo.**

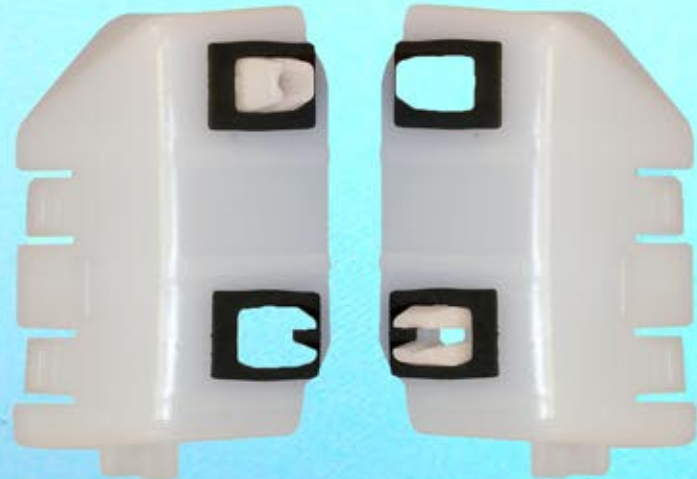
164.727 - Izdo. 164.726 - Dcho.

164.850 - Dcho/Izdo.

164.729 - Izdo.
164.728 - Dcho

U.E.	DESCRIPCION	261	Ref. Adaptable
1	Soporte cristal elevalunas derecho Terrano '93->'06 (ver Mercedes)	164.494	
1	Soporte cristal elevalunas izquierdo Terrano '93->'06 (ver Mercedes)	164.495	
1	Kit soporte cristal elevalunas delantero derecho Primera '02->'07	164.498	
1	Kit soporte cristal elevalunas delantero izquierdo Primera '02->'07	164.499	
1	Soporte parachoques delantero derecho Qashqai '10->'13	164.726	62222-BR00A
1	Soporte parachoques delantero izquierdo Qashqai '10->'13	164.727	62223-BR00A
1	Soporte parachoques trasero derecho Qashqai '06->'13	164.728	85226-JD01A
1	Soporte parachoques trasero izquierdo Qashqai '06->'13	164.729	85227-JD01A
1	Soporte parachoques trasero derecho e izquierdo Qashqai '06->'13	164.850	85222-JD00A



164.282



164.429



163.594



163.156



163.904



164.232



164.229



164.231



163.158



163.155



163.279



163.157



163.480



163.615

U.E.	DESCRIPCION	261	Ref. Adaptable
10	Clip fijac. parrilla radiador - varios modelos -	163.155	62318-0T001
25	Clip fijac. molduras pasoruada Patrol, Terrano, Terrano II, fijac. molduras laterales Terrano II, fijac. revest. portón trasero Almera Tino, Terrano II	163.156	01553-02903
10	Clip fijac. parachoques Serena	163.157	01553-01342
25	Clip fijac. parrilla radiador Almera, Micra, Primera, Terrano II	163.158	01553-05751
10	Clip fijac. parrilla radiador Micra, Primera	163.279	26399-3J110
25	Fijac. varias capó Primera	163.480	01552-00661
25	Fijac. "torpedo" parabrisas Cabstar '06-> (Eurocode 6045ASCVB) (ver Ford, Opel, PSA)	163.594	01553-0813M
10	Fijac. insonorizante capó Almera, Maxima, Micra '92, Micra '03	163.615	65846-30F00
25	Fijac. rejilla parabrisas "torpedo" Primera P11 y P12 '96-> (Eurocode 5981ASCS) y varios usos Micra '92->'02	163.904	66820-9F900
25	Fijac. juntas goma puerta Murano '05->, Patrol '98->'06	164.229	01553-09311
10	Fijac. parrilla radiador Almera '95->'00, Micra ->'02, Murano, NV200, Patrol, Pathfinder, Qashqai, Terrano 2	164.231	76882-0M060
10	Fijac. rejilla parabrisas "torpedo" Primera (P10) '90->'96, Terrano 2 (Eurocode 5981ASCH8B)	164.232	66820-50J10
10	Fijac. moldura superior parabrisas Primastar '01-> (ver Opel, Renault)	164.282	
10	Fij. rejilla parabrisas "torpedo" Almera '95->'00, Cabstar '07->'13, Patrol '98->'06, Primera '95->'02, Terrano 2 '93->'00, 350Z (Eurocode 6015ASCST)	164.429	72714-0P005



U.E.	DESCRIPCION	261	Ref. Adaptable
50	Fijac. revestimientos interiores - varios modelos - (ver Ford)	162.910	01553-0801M
10	Fijac. panel puerta Primera	163.483	01553-08101
10	Fijac. panel puerta y tapizados interiores Almera, Almera Tino, Maxima, Micra, Navara, Qashqai, Patrol, Primera, Sunny, Terrano, X-Trail, 350Z	163.806	80999-VE000 01553-08371 01553-07381
10	Fijac. panel puerta y tapizados interiores Micra C+C '05->, Murano, Primera '01->, Qashqai, Sunny, Teana, X-Trail, 350Z	163.807	01553-07111 84953-AU100
10	Fijac. tapizados interiores Micra '03->'10, Primera '00	164.227	76988-3J000
10	Fijac. moldura aletas Juke '10->, X-Trail '07->	164.284	76882-JG10A
25	Fijac. tapizados interiores Micra '03 y '10->, Juke, Navara '05->, Note, NV200, Pathfinder '05->, Primera, Qashqai '06->, X-Trail	164.300	01553-30001 01553-09791
10	Fijac. moldura aletas Patrol '00->	164.580	63848-VD210
10	Fijac. moldura aletas Juke '10->	164.582	76847-JG00A
25	Fijac. moldura talonera puerta Juke '10->	164.584	76882-EW00B
10	Fijac. moldura talonera puerta Juke '10->, X-Trail '14->	164.585	76882-EG01A
10	Fijac. tapizados interiores Micra '95 y '03->, Note '03->, Tiida	164.623	01281-01371
10	Fijac. moldura portón trasero Cube, NV200, X-Trail	164.636	01553-10701
25	Fijac. moldura aleta Qashqai '06->	164.638	01553-JD01B 01553-JD01A
25	Fijac. tapizados interiores X-Trail (T31) '07->'13, Urvan '01->'13	164.683	01553-08911

261/

7 x 7
Tornillo Ø 3,5



162.817

8 x 8
Tornillo Ø 4,8



164.579

8 x 8,5
Tornillo Ø 4,8



163.520

8,5 x 8,5
Tornillo Ø 5,5



163.268

8,5 x 8,5
Tornillo Ø 5,5



164.581

9,5 x 9,5
Tornillo Ø 5,5



164.801

8,5 x 8,5
Tornillo Ø 5,5



163.484

9,8 x 10,5
Tornillo Ø 5,5



164.634

8 x 11,8
Tornillo Ø 5,5



164.635

8 x 11,6
Tornillo Ø 5,5



164.583

7,8 x 11,8
Tornillo Ø 5,5



163.120

8 x 11,6
Tornillo Ø 5,5



164.101

Tornillo Ø 4,2



164.424



164.425



163.280

Ø 4,7



163.481

Ø 6,2



163.385

Ø 8



162.934

Ø 8



164.627

U.E.	DESCRIPCION	261	Ref. Adaptable
25	Taco fijac. varios usos - varios modelos - (ver VAG)	162.817	SS-06-0364A
100	Fijac. tapizados interiores - varios modelos - (ver Mercedes, PSA, Renault)	162.934	SS-07-0069A
10	Taco fijac. aletas Nissan Terrano II '96-> y varios usos Nissan	163.120	01553-02923
10	Fijac. tapizados y varios usos Nissan Micra, Montero, Pajero, Space Runner, Sunny (ver Mitsubishi)	163.268	01281-00231
10	Fijac. tapizados interiores - varios modelos -	163.280	01553-00051
25	Fijac. tapizados interiores Primastar (ver Opel, Renault)	163.385	
25	Fijac. soporte parachoques Micra	163.481	01553-01A50
50	Fijac. tapizados puerta X-Trail	163.484	62698-V7000 67898-U7400
10	Fijac. tapizados interiores - varios - (ver Honda, Mazda, Toyota)	163.520	01651-00481
10	Fijac. varios usos Patrol, Pathfinder, Terrano (ver Renault)	164.101	76848-51S00
10	Fijac. pasoruada Almera, Almera Tino, Primera, Qashqai, Micra '10->, Murano, X-Trail	164.424	76882-0M000
10	Fijac. pasoruada Almera '00->'06, Primera '01->'07, Qashqai	164.425	63848-4M500
25	Fijac. moldura aleta X-Trail '07->, Murano '05->	164.579	76881-JG00A
10	Fijac. parachoque trasero Note, Qashqai y Infiniti	164.581	63846-5V000
25	Fijac. moldura aleta Juke '10->, X-Trail '07 y '14->	164.583	76848-JG00A
10	Fijac. refuerzo parachoque Qashqai '06->	164.627	62228-JD00A
25	Fijac. panel puerta Juke, Qashqai, y fijac. otros usos otros modelos	164.634	01281-00111
10	Fijac. moldura aleta trasera Juke '13->, Murano '13->, Qashqai '13->, X-Trail '07->	164.635	76848-JG00B
10	Fijac. parachoque trasero Murano '05->	164.801	01281-01431

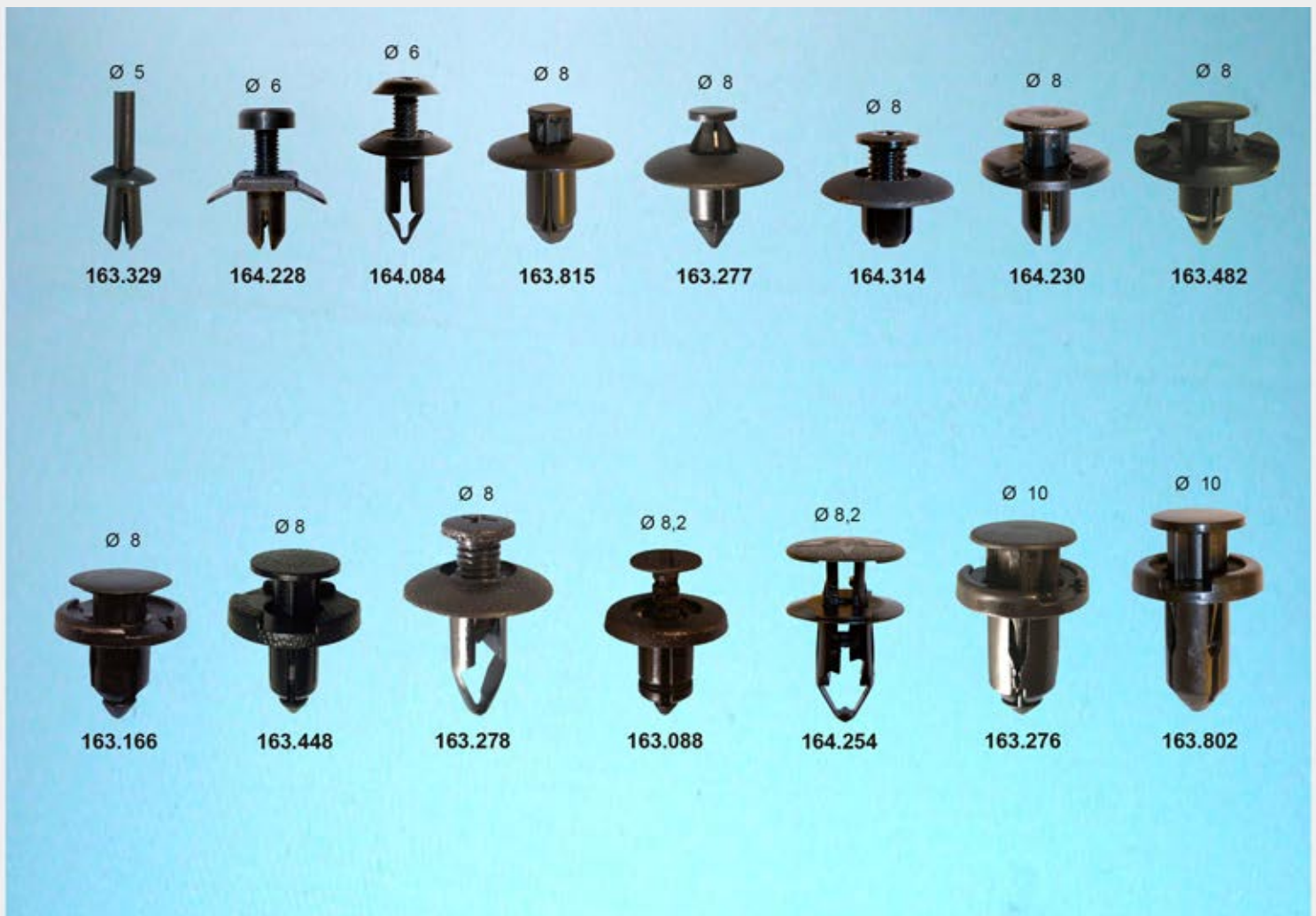

U.E.	DESCRIPCION	261	Ref. Adaptable
50	Fijac. parachoques Micra (ver Dacia, Opel, Renault)	163.088	01515-00QAB
50	Fijac. parachoques y otros usos Almera Tino, Note, Primera, Teana, Tiida, X-Trail (ver Lexus, PSA, Toyota)	163.166	01553-09611
50	Fijac. bajos carrocería Nissan Qashqai, fijac. parachoques Nissan - varios - (ver Subaru)	163.276	01553-09241
25	Fijac. parachoques, molduras pasoruada y tapizados interiores Almera, Almera Tino, Micra '03->, Primera P10 ('90->'96) y P11 ('96->'02), Serena, Sunny, Terrano II (ver Honda, Volvo)	163.277	63848-01G00
25	Fijac. parachoques, molduras pasoruada y parrilla radiador Galant, Micra, Montero, Pajero, Space Runner, Sunny	163.278	63854-01A00
50	Remache fijación varios usos (ver VAG)	163.329	
25	Fijac. rejilla radiador Cabstar '06->, Juke, Murano, Note, fij. parachoque trasero Mira '03->'10, Note, fij. spoiler delantero Micra '10-> (ver, Renault)	163.448	11296-AG000
25	Fijac. pasoruada Qashqai, X-Trail, fijac. parachoque, aletas, rejilla calandra Qashqai (ver Honda, Mitsubishi)	163.482	01553-09321
25	Fijac. parachoques Almera '00, Almera Tino, Micra, Murano, Navara, Note, Pathfinder, Patrol, Primera, Qashqai, Sunny, Teana, Terrano, Tiida, X-Trail, 350Z (ver Honda)	163.802	
25	Fijac. parachoques Sunny, Terrano II, X-Trail '07->	163.815	01553-06721
25	Fijac. rejilla parabrisas "torpedo" y otros varios usos Almera, Cabstar, Micra, Note, Patrol, Primera, Qashqai, Teana, Tiida, Vanette (Eurocode 6041ASCH)	164.084	66860-01W01
25	Fijac. rejilla parabrisas "torpedo" Patrol '98->'06	164.228	66824-W1000
10	Fijac. pasoruada y otros usos Juke, Micra '10, Navara '05, Pathfinder '05, Patrol '00, X-Trail '07 (ver Mazda, Renault)	164.230	01553-05933 01553-05323 01553-10721
25	Fijac. parachoques y parrilla radiador Qashqai, fijac. parachoques Micra '03->, Note '06-> (ver Dacia, Renault)	164.254	01515-00Q0C
25	Fijac. pasoruada Terrano II (ver Toyota)	164.314	63848-01J00

Ø 4,8 x 15
arandela Ø 15



161.473

Ø 4,8 x 18
arandela Ø 15



161.474

Ø 5 x 22
arandela Ø 16



161.750

Ø 5,5 x 19
arandela Ø 18



162.555

Ø 5,5 x 19
arandela Ø 22



161.742

Ø 6 x 20



161.721

Ø M6 x 20
arandela Ø 18



161.727

Ø 6,3 x 19
arandela Ø 18



162.556

Ø 6,3 x 19
arandela Ø 22



161.743

Ø 2,4 x 5



162.362

U.E.	DESCRIPCION	261	Ref. Adaptable
50	Tornillo Ø 4,8 x 15 (aro Ø 15), varios usos (ver BMW, Ford, Mercedes, PSA, VAG)	161.473	
50	Tornillo Ø 4,8 x 18 (aro Ø 15), varios usos (ver BMW, Ford, Mercedes, PSA, VAG)	161.474	20 20 005 11071511
25	Tornillo Ø 6 x 20, varios usos (ver PSA, Renault)	161.721	
25	Tornillo Ø 6 x 20 (aro Ø 18), varios usos (ver Dacia, Renault)	161.727	
50	Tornillo Ø 5,5 x 19 (aro Ø 22), sujeción guardabarros (ver BMW, Ford, Mercedes, VAG)	161.742	
50	Tornillo Ø 6,3 x 19 (aro Ø 22), sujeción guardabarros (ver BMW, Ford, Mercedes, VAG)	161.743	
25	Tornillo Ø 5 x 22 (aro Ø 16), varios usos (ver Dacia, Renault)	161.750	
50	Remache Ø 2,4 x 5, fijac. varias aplicaciones Ascona, Calibra, Corsa A y B, Kadett, Vectra A y B (ver Fiat, Ford, PSA, Renault, VAG)	162.362	01 64 361 90033713
50	Tornillo Ø 5,5 x 19 (aro Ø 18), sujeción guardabarros (ver Ford, VAG)	162.555	20 22 107 20 26 706 11093351
50	Tornillo Ø 6,3 x 19 (aro Ø 18), sujeción guardabarros (ver BMW, Ford, Mercedes, VAG)	162.556	20 22 203



U.E.	DESCRIPCION	261	Ref. Adaptable
50	Clip fijac. parachoques Corsa C, Meriva, fijac. panel toma aire Corsa B (ver BMW, Renault, VAG)	161.427	20 72 082 11090592
50	Clip fijac. frontal Corsa, Kadett, Astra (ver Ford, VAG)	161.465	207217563
50	Clip fijac. varios usos Opel - varios modelos - (ver BMW, Ford)	161.704	20 72 077
25	Clip fijac. placa matricula Opel Agila, Ascosa, Astra F, Calibra, Corsa A, B y C, Kadett, Signum, Vectra A, B y C	161.745	11 88 303 90053225
25	Clip fijac. aletas Astra F, G y H, Corsa B y D '07->, Vectra B y C, Signum, Zafira A y B	161.756	20 72 001 11094002
25	Clip fijac. aletas delanteras Astra H, Corsa D '07->	161.781	11 10 936 13154960
25	Clip fijac. parachoque Astra G, Omega B, Vectra B, Zafira A, fijac. tapizados interiores Astra G y H, Vectra C, Zafira A y B	161.815	14 00 906 90464538
50	Clip fijac. tapizados interiores Astra G y H, Corsa B y C, Meriva A, Signum, Vectra B y C, Zafira A y B	161.816	22 26 950 90355465
25	Fijac. anagramas modelos (ver Ford)	162.266	01 74 751
25	Tuerca con aro móvil, varios usos (ver Dacia, Ford, PSA, Renault, VAG)	162.711	20 64 162 11095121
25	Tuerca con aro móvil, varios usos (ver Ford, PSA, Renault, VAG)	162.712	20 66 027 11074603



181.417*



164.141



162.918

* (imagen NO a tamaño real)

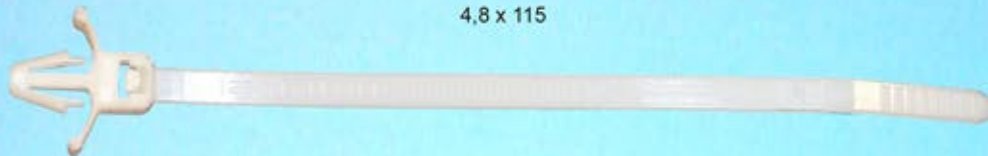

4,8 x 115

301.290



162.874



163.057



164.132

U.E.	DESCRIPCION	261	Ref. Adaptable
10	Fijac. mando calefacción Ascona, Astra F, Calibra, Omega A, Senator B, Vectra A	162.874	18 24 622
10	Fijac. cableado Astra F, Calibra, Omega, Senator, Vectra A (ver BMW, Ford)	162.918	12 88 548 90230571
10	Fijac. varilla capó Astra G, Calibra, Corsa'94, Omega A, Vectra A (ver Mercedes)	163.057	11 80 216 11 80 411 90246867
10	Fijac. varilla capó Ampera, Signum, Vectra C	164.132	11 78 892 13238221
25	Fijac. cierre puertas Astra F, Corsa A, B y C, Kadett, Meriva A, Vectra A y B	164.141	01 34 786 90044397
-	Tirante bandeja posterior Opel Corsa B (long.total 285 mm.)	181.417	
50	Fijac. cable airbag Corsa C, Vectra C, fij. otros usos Astra F y G, Corsa B y D, Vectra A y B, Zafira B	301.290	12 88 888 90461994



173.197



178.098



162.281



162.412



162.809



162.345

U.E.	DESCRIPCION	261	Ref. Adaptable
25	Fijac. faro Frontera, Kadett, Omega, Senator	162.281	12 18 601 90181010
25	Fijac. faro Ascona C	162.345	12 16 904 90123504
25	Fijac. faro Corsa A	162.412	12 17 801 90321482
25	Fijac. faro Corsa B '93, Tigra	162.809	12 18 604 90386374
1	Regulador eléctrico faro Astra H, Insignia '09, Signum, Vectra C '02->'05 (ver VAG)	173.197	62 07 109 13142042
1	Regulador eléctrico faro Corsa D, Meriva, Signum, Tigra '04, Vectra C '05-> (ver VAG)	178.098	12 07 203 13129840

261

164.337 *- Izdo.

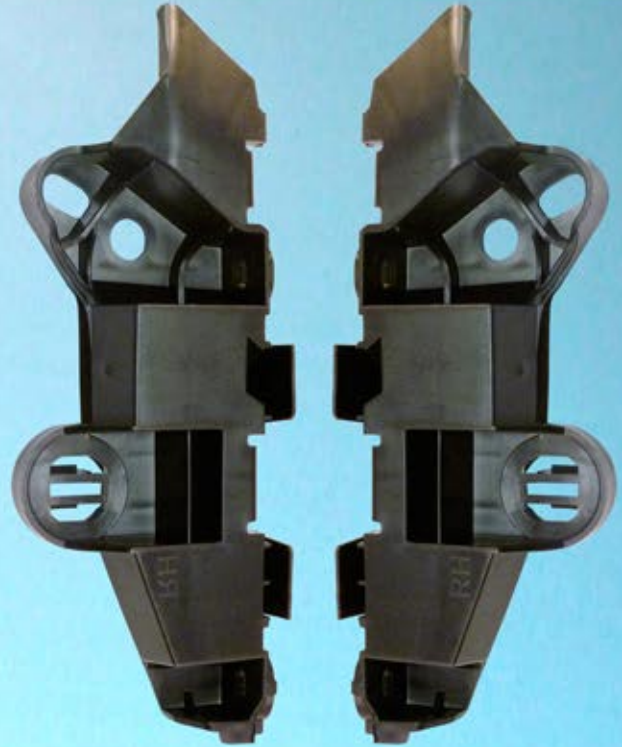
164.336 *- Dcho.

164.747 *- Izdo.
164.746 *- Dcho.

164.775 *- Izdo.

164.774 *- Dcho.

* (imagen 1/2 tamaño real)

U.E.	DESCRIPCION	261	Ref. Adaptable
1	Soporte parachoques delantero derecho Corsa D '06->'13	164.336	14 06 208 13179961
1	Soporte parachoques delantero izquierdo Corsa D '06->'13	164.337	14 06 207 13179960
1	Soporte parachoques delantero derecho Corsa E '14->	164.746	39059837 13430030
1	Soporte parachoques delantero izquierdo Corsa E '14->	164.747	39059836 13430029
1	Soporte parachoques delantero derecho Meriva B '10->'14	164.774	14 06 276 13267762
1	Soporte parachoques delantero izquierdo Meriva B '10->'14	164.775	14 06 264 13267761

261/

164.745 *- Izdo.



164.744 *- Dcho.

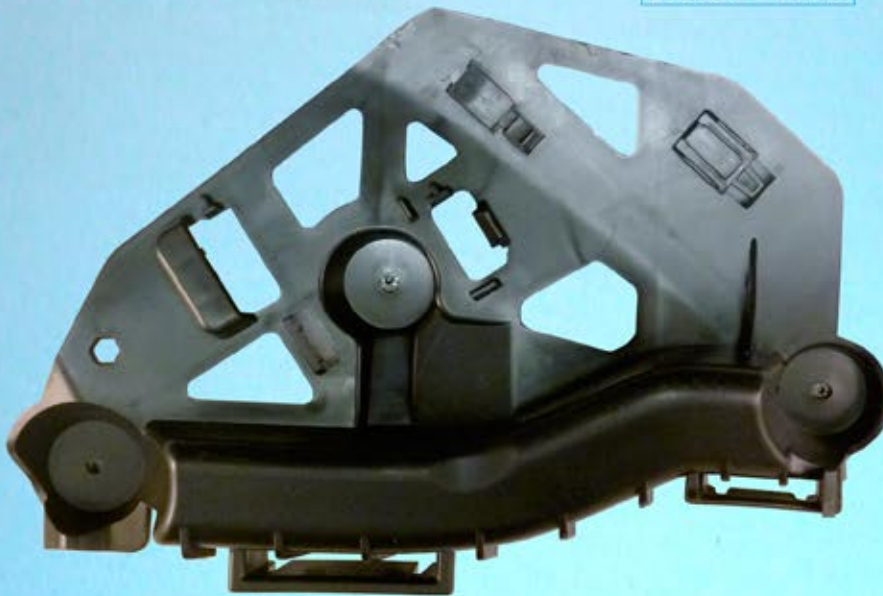

164.749 - Izdo.



164.748 - Dcho.



164.751 *- Izdo.



164.750 *- Dcho.

* (imagen 1/2 tamaño real)

U.E.	DESCRIPCION	261	Ref. Adaptable
1	Soporte parachoques delantero derecho Corsa E '14->	164.744	39014303 13430027
1	Soporte parachoques delantero izquierdo Corsa E '14->	164.745	39014302 13430025
1	Soporte parachoques trasero derecho Corsa E '14->	164.748	13399580
1	Soporte parachoques trasero izquierdo Corsa E '14->	164.749	13399578
1	Soporte parachoques trasero derecho Corsa E '14->	164.750	39002836 13399576
1	Soporte parachoques trasero izquierdo Corsa E '14->	164.751	39002835 13399574

2617



164.771 *- Izdo.



164.770 *- Dcho.



164.773 *- Izdo.



164.772 *- Dcho.

* (imagen 1/2 tamaño real)

U.E.	DESCRIPCION	261	Ref. Adaptable
1	Soporte parachoques delantero derecho Zafira B '05->'11	164.770	14 06 606 13124998
1	Soporte parachoques delantero izquierdo Zafira B '05->'11	164.771	14 06 607 13124997
1	Soporte parachoques trasero derecho Zafira B '05->'11	164.772	14 06 196 13125037
1	Soporte parachoques trasero izquierdo Zafira B '05->'11	164.773	14 06 195 13125036



163.560



163.559*



163.562 - Dcho.
163.563 - Izdo.



163.561

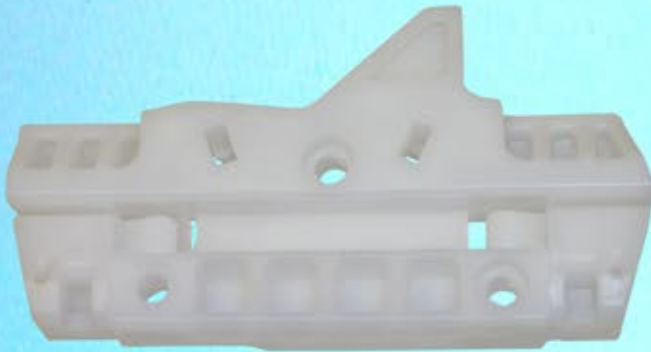

164.476 - Dcho.
164.477 - Izdo.



164.008*- Dcho.
164.009*- Izdo.

* (imagen 1/2 tamaño real)

U.E.	DESCRIPCION	261	Ref. Adaptable
1	Soporte cristal elevalunas derecho e izquierdo Corsa	163.559	
1	Soporte cristal elevalunas derecho e izquierdo Astra, Vectra	163.560	
10	Patin cristal elevalunas derecho e izquierdo Astra, Vectra	163.561	
1	Soporte cristal elevalunas derecho Meriva	163.562	
1	Soporte cristal elevalunas izquierdo Meriva	163.563	
1	Soporte cristal elevalunas derecho Meriva (ver Fiat, PSA, Renault)	164.008	
1	Soporte cristal elevalunas izquierdo Meriva (ver Fiat, PSA, Renault)	164.009	
1	Soporte cristal elevalunas derecho Corsa D '06->	164.476	
1	Soporte cristal elevalunas izquierdo Corsa D '06->	164.477	

163.732

162.937

163.345

164.442

164.655

164.433

164.282

162.938

163.642

U.E.	DESCRIPCION	261	Ref. Adaptable
10	Fijac. moldura parabrisas (parte delantera) Astra G '98->'04 (Eurocode 6284ASCHS)	162.937	01 88 550 01 88 574 90587517
10	Fijac. moldura techo-parabrisas (parte delantera y final) Astra G '98->'04 (Eurocode 6284ASCH1T)	162.938	01 88 577 9131114
10	Fijac. molduras laterales parabrisas Zafira A '99->'04 (Eurocode 6283ASCH / 6283ASCVS)	163.345	01 88 581 90580920
10	Fijac. moldura techo-parabrisas (parte central) Astra G Coupé, Sedán y Familiar '98->'04	163.642	01 88 580 9131181
10	Fijac. moldura lateral parabrisas Astra G '98->'04 (Eurocode 6284ASCHD)	163.732	01 88 573 90562265
10	Fijac. moldura superior parabrisas Vivaro '01->'14 (ver Nissan, Renault)	164.282	44 09 106 91166383
10	Fijac. moldura superior parabrisas Vivaro '01->'14	164.433	44 06 961 93854508
10	Fijac. moldura parabrisas Vivaro '15-> (Eurocode 6340ASCVS6B) (ver Fiat, Renault)	164.442	44 07 244 93453383
10	Fijac. rejilla parabrisas "torpedo" Mokka '13-> (Eurocode 6337ASCRB) (ver Chevrolet)	164.655	20 97 004 11546904



163.852



163.431



163.851



164.025



162.826



163.594



164.093



163.876



163.899



7 x 15
Tornillo Ø 3,9

163.882

U.E.	DESCRIPCION	261	Ref. Adaptable
25	Fijac. rejilla parabrisas "torpedo" Vivaro A '01-'14, Movano B '15-> (Eurocode 6300ASCVB) (ver Renault)	162.826	44 14 667 91169651
50	Fijac. moldura rejilla lavaparabrisas "torpedo" Astra H '04-'09, Zafira B '05-'12 (Eurocode 6302ASCHB)	163.431	51 04 988 13155024
25	Fijac. rejilla parabrisas "torpedo" Adam, Meriva B '10-> (Eurocode 6558LSCVFD) (ver Ford, Nissan, PSA)	163.594	01 76 073 13317099
10	Fijac. moldura techo-parabrisas Zafira A '99-'04	163.851	01 88 582 90580928
10	Fijac. moldura inferior parabrisas Agila '00-'07 y '08-> (Eurocode 6291ASCV) (ver Fiat, Suzuki)	163.852	47 07 662 9216439
25	Fijac. moldura parabrisas Combo, Meriva A '03-'10 (ver PSA, Renault)	163.876	12 22 141 24405740
10	Fijac. rejilla parabrisas "torpedo" Opel Vivaro '15-> (Eurocode 6340ASCVS) (ver Fiat, PSA, Renault)	163.882	44 07 241 93452279
25	Fijac. moldura techo Zafira B '05-'12 (Eurocode 6290ASCH)	163.899	22 28 839 24405739
10	Fijac. moldura inferior parabrisas Astra J '10->, Cascada '13 (Cabrio) (Eurocode 6324ASCHBS)	164.025	01 68 107 13280305
10	Fijac. moldura parabrisas Zafira C '12-> (Eurocode 6332ASCMS)	164.093	20 73 199 11611111

163.425

163.930

163.901

163.800

164.272

164.273

U.E.	DESCRIPCION	261	Ref. Adaptable
10	Fijac. soporte parabrisas Movano (Eurocode 7247ASCV) (ver Fiat, Renault)	163.425	45 00 292 44 15 522 93181418
10	Fijac. moldura lateral techo Astra H, Zafira B	163.800	01 87 925 73 51 804 93348922
10	Fijac. moldura techo Meriva A '03->'10, Signum, Vectra C	163.901	01 87 918 9185662
10	Fijac. moldura techo Corsa C '00->'06	163.930	01 88 551 9114735
10	Fijac. moldura techo Meriva B '10->	164.272	01 87 336 13339101
10	Fijac. moldura techo Meriva B '10->	164.273	01 87 339 13344957



U.E.	DESCRIPCION	261	Ref. Adaptable
100	Fijac. rejilla calandra Zafira B '05, fijac tapizados interiores Astra F, Corsa A y B, Kadett, Omega B, Vectra A y C (Negro) (ver PSA, Renault)	162.221	23 46 824 23 38 961 90283614
100	Fijac. panel y tapicería todos los modelos (Gris) (ver PSA, Renault)	162.222	22 26 953 90328384
50	Fijac. deflector aire Signum, Vectra C (ver BMW, Ford, VAG)	162.782	22 07 713 90082231
50	Fijac. tapizados interiores (color negro)	162.968	
25	Fijac. tapizados interiores Astra F, G y H, Calibra, Kadett, Omega, Vectra A y B, Zafira B	163.066	22 08 843 90218614
25	Fijac. agujeros Ø 6,5 Ascona, Astra F y G, Calibra, Corsa A, Kadett, Omega, Senator	163.079	11 62 484 90040750
25	Fijac. tapizados interiores Vivaro (ver Nissan, Renault)	163.385	
50	Fijac. moldura pasoruada Astra F, Kadett, Vectra A, fijac. panel radiador Corsa B	163.678	09 12 466 90335715
50	Fijac. tapiz. alfombras piso Astra G, Calibra, Combo, Corsa A, Kadett E, Omega A y B, Vectra A y B, fijac. ajuste respaldo Agila, Astra H, Corsa C, Meriva, Zafira B	163.902	22 40 861 90022049

162.319

162.411

162.324

162.944

163.675

163.676

163.798

163.799

U.E.	DESCRIPCION	261	Ref. Adaptable
10	Fijac. moldura lateral puerta y aletas Ascona '82, Corsa A, Kadett E	162.319	01 74 843 90119995
10	Fijac. molduras - modelos antiguos -	162.324	
25	Fijac. moldura Corsa	162.411	01 74 846
10	Fijac. molduras laterales traseras Astra '98, 3 puertas (ver BMW)	162.944	01 72 017 90590995
10	Fijac. moldura portón trasero Zafira	163.675	01 74 836 90588746
10	Fijac. moldura portón trasero Zafira	163.676	01 74 845 90588747
10	Fijac. moldura talonera puerta Corsa A y B, Kadett E, Vectra A	163.798	01 64 978 90196277
10	Fijac. moldura portón trasero y luneta trasera Vectra B Familiar, fijac. moldura lateral Omega A	163.799	01 74 853 90376175



162.992



162.993



162.994



162.824



163.332



163.434



163.149



163.432



163.433



163.065



163.911



164.541



164.782



164.802



164.803

U.E.	DESCRIPCION	261	Ref. Adaptable
50	Fijac. moldura lateral Vivaro (componente del kit OEM: 44 09 963 / 93160023) (ver Renault)	162.824	
50	Fijac. moldura lateral Vivaro (ver Fiat, Renault)	162.992	
50	Fijac. moldura lateral Vivaro (componente del kit Opel Vivaro OEM: 44 09 963 / 93160023) (ver Fiat, Renault)	162.993	44 12 053 91169650
25	Fijac. moldura lateral Vivaro (componente del kit OEM: 44 09 963 / 93160023) (ver Renault)	162.994	
50	Fijac. moldura lateral puerta, talonera puerta y aletas Astra G, Corsa B, Signum, Vectra B y C, Zafira A	163.065	01 74 864 01 74 854 90481595
25	Fijac. moldura lateral puerta Astra G ('98->'03), 3 y 5 puertas	163.149	01 72 923 90590944
50	Fijac. moldura pasoruada delantero Corsa C y Combo	163.332	01 22 920 9114743
25	Fijac. molduras laterales Vectra B	163.432	01 71 964 90508326
25	Fijac. molduras laterales Vectra B	163.433	01 71 965 90508327
25	Fijac. molduras laterales Signum, Vectra C	163.434	01 72 985 9177065
50	Fijac. moldura lateral puerta, talonera puerta y aletas Corsa B, Signum, Omega B, Vectra B, Zafira A	163.911	01 74 611 01 29 943 90580707
10	Fijac. molduras anagrama trasero Antara '12->	164.541	20 73 024 11611375
25	Fijac. moldura pasoruada Mokka '13->	164.782	20 73 255 11562250
25	Fijac. moldura cristal puerta Zafira C '12-> (ver Ford)	164.802	20 73 065 11610669
25	Fijac. moldura puerta y talonera puerta Mokka '13-> (ver Ford)	164.803	12 22 281 11610926

162.630

162.410

163.614

163.679

163.680

164.046

164.047

164.121

164.575

164.759

U.E.	DESCRIPCION	261	Ref. Adaptable
50	Fijac. panel puerta Astra F, Ascona, Corsa A, Kadett	162.410	22 40 582 22 40 587 90321121
50	Fijac. panel puerta Kadett	162.630	
50	Fijac. tapizados puerta Astra H, Corsa C, Meriva A y B, Signum, Vectra B y C, Zafira B, fijac. tapizados interiores Astra G, Corsa B	163.614	01 49 910 90560163
50	Fijac. tapizados interiores pilar central Astra G, Zafira A	163.679	01 22 915 90589557
50	Fijac. tapizados interiores Astra F	163.680	01 49 907 90414663
50	Fijac. panel puerta Adam, Astra J, Corsa E, Insignia, Meriva B '10->, Zafira C '12-> (ver Chevrolet)	164.046	72 31 991 13252118
50	Fijac. panel puerta Astra J, Corsa E, Insignia, Meriva B '10->, Zafira C '12-> (ver Chevrolet)	164.047	72 31 992 13252119
50	Fijac. panel puerta Astra H (3 puertas)	164.121	22 45 922 13284155
25	Fijac. panel puerta trasera Mokka	164.575	20 73 050 11610606
25	Fijac. panel puerta Antara '12->, fijac. panel puerta delantera Mokka	164.759	23 45 417 11610605

163.141

162.826

163.012

163.064

162.853

163.669

163.435

163.876

163.899

U.E.	DESCRIPCION	261	Ref. Adaptable
25	Fijac. rejilla parabrisas "torpedo" y tapizados interiores Opel Vivaro '01-> (Eurocode 6300ASCVB) (ver Renault)	162.826	44 14 667 91169651
25	Fijac. revestimiento interior traseros Vectra A y B	162.853	23 40 950 90269693
50	Fijac. panel puerta Astra H, Corsa C, Corsa D '07->, Meriva A '03->, Zafira B '05-> (ver Chevrolet)	163.012	23 45 957 90321122
25	Fijac. panel puerta Astra F, Vectra C	163.064	23 45 959 90457899
25	Fijac. panel puerta y tapizados interiores Movano, Vivaro (ver Land Rover, Renault)	163.141	44 30 858 44 14 720 93161475
25	Fijac. panel puerta Corsa C, Combo, fijac. tapizados interiores Astra G, Meriva, Zafira A	163.435	22 28 838 9133594
25	Fijac. panel puerta Movano B '10->, Vivaro B '15-> (ver PSA, Renault)	163.669	44 01 109 95508766
25	Fijac. tapiz. interiores Adam, Antara '12, Astra J, Corsa D, Insignia, Meriva B '10, Signum, Vectra C, Zafira B y C, fijac. talonera puerta Corsa C y D, Meriva A '03, Vectra C, Signum, Zafira B '05, fij. moldura anagrama trasero Zafira C '12-> (ver Chevrolet, PSA, Renault)	163.876	12 22 141 24405740
25	Fijac. revestimientos interiores pilar A y entrada a puerta Astra H, Corsa C y D, Insignia, Meriva, Signum, Vectra C, Zafira B, fijac. moldura techo Zafira B (Eurocode 6290ASCH)	163.899	22 28 839 24405739



U.E.	DESCRIPCION	261	Ref. Adaptable
50	Fijac. junta goma puertas y techo Astra H, Corsa D, Meriva, Zafira A y B (ver Ford, VAG)	162.844	01 57 979 90579619
50	Fijac. aislante capó Agila, Astra F, G y H, Corsa A, B, C y D, Kadett, Meriva, Omega, Signum, Vectra A, B y C, Zafira A y B	162.970	11 62 488 90355604
25	Fijac. parrilla radiador Campo, Frontera, Monterrey (ver Honda, Mazda, Toyota)	163.159	13 20 703 94218027
50	Fijac. junta puerta Astra G, Insignia, Zafira A	163.436	01 57 905 90562273
50	Fijac. pasoruada Corsa C, fijac. parachoque Vectra B, Zafira A, fijac. tapizados y otros usos interiores Astra G y H, Meriva, Omega B, fijac. faro antiniebla Corsa C, Meriva, Omega B, Vectra B, Zafira A	163.897	12 35 884 24417039
50	Fijac. pasoruada y parachoques Astra H, Corsa D, Insignia, Meriva A y B, Signum, Vectra C, Zafira B, fijac. antiniebla delantero Astra H, Insignia, Vectra C, Zafira B, fijac. antiniebla trasero Corsa C	163.898	14 04 969 24449408
50	Fijac. insonorizante capó Astra G, Combo, Corsa B y C, Insignia, Tigra B, Vectra B y C, Zafira A	163.919	11 62 742 13265959
50	Fijac. junta puerta Astra J '09->, Insignia, Meriva B '10->, Zafira C '12->	164.351	01 48 311
50	Fijac. junta puerta Astra J '09->, Cascada '13->, Meriva B '10->	164.781	01 48 315 01 64 067 13350982



U.E.	DESCRIPCION	261	Ref. Adaptable
25	Fijac. parrilla radiador Astra H (ver Renault)	162.903	13 20 925 13240067
50	Fijac. (tornillo Ø 6) aleta delantera Corsa B, Omega, Vectra A, fijac. bajos carroceria Corsa A (ver BMW, Ford, Mini, V.A.G.)	162.948	1 80 940 90127883
25	Fijac. placas matrículas Opel Astra F, Calibra, Kadett, Omega, Senator	162.974	11 90 365 90139015
25	Fijac. revestimientos parachoques Astra F, G y H, Corsa B, Calibra, Omega, Signum, Vectra B y C, Zafira A	163.039	14 06 984 90482706
50	Fijac. (tornillo Ø 5) guardabarros y pasorueda Astra G, Corsa B y C, Meriva, Zafira B, y tapizados interiores Astra G y H, Corsa B y C, Combo, Meriva, Omega, Tigra, Zafira	163.150	01 71 953 90377951
25	Fijac. aleta y moldura lateral puerta Opel Movano (ver Dacia, Fiat, PSA, Renault)	163.222	45 01 607 9161907
50	Fijac. (tornillo Ø 5) pasorueda Astra J, Corsa E, Meriva B '10->, fij. revestimientos interiores Astra F, G y H, Calibra, Corsa A, B, C y D, Meriva, Insignia, Signum, Vectra B y C, Zafira A y B	163.437	01 80 942 90413589
50	Fijac. piloto trasero Astra H, fijac. faro delantero Astra F, Calibra, Omega, Senator, Vectra A, fijac. rejilla radiador Corsa B, Combo (ver Ford)	163.439	12 16 957 90230960
50	Fijac. moldura talonera puerta Vectra B, fijación tapizados interiores Meriva, Combo fij. faro delantero Corsa D,	163.677	08 17 950 90287467
10	Fijac. panel puerta Vivaro B '15->, fijac. rejilla parabrisas "torpedo" Opel Vivaro '15-> (ver Fiat, PSA, Renault)	163.882	44 07 241 93452279
25	Fijac. placa matrícula trasera Opel Astra F, Calibra, Corsa A, Euromidi, Frontera A, Kadett E, Omega A, Vectra A	163.916	11 90 970 90053803
50	Fijac. tapizados interiores Antara '07-> (ver Chevrolet)	164.134	48 04 338 94515248
25	Fijac. faro delantero Astra G y H, Corsa C, Meriva A, Vectra C, Zafira B	164.576	12 74 977 90506890



U.E.	DESCRIPCION	261	Ref. Adaptable
100	Fijac. varios usos (ver BMW, Mercedes, PSA, VAG)	162.431	
100	Fijac. molduras parachoques y fijac. pasoruedas Astra F, Calibra, Corsa A y B, Kadett, Omega, Vectra A (ver Renault)	162.819	17 19 242 90058826
50	Fijac. parachoques trasero Astra H, Combo, Meriva, Insignia, fijac. parachoques delantero Astra F (ver BMW)	163.047	14 00 804 90414659
50	Fijac. parachoques delantero y trasero Astra G y H, Corsa C, Meriva A y B, Signum, Tigra, Vectra B y C, Zafira A y B	163.048	14 00 806 90508809
50	Fijac. parachoques, pasoruada y spoiler Astra H, Signum, Vectra C, Zafira A y B, fijac. revestim. interiores Astra G y H, Corsa D '07	163.054	14 06 925 9130754
50	Fijac. rejilla parabrisas "torpedo" Vivaro (Eurocode 6300ASCVBK) (ver Dacia, Fiat, Renault)	163.140	44 14 666 91169621
25	Fijac. varios usos Opel Frontera, Euromidi (ver Mercedes, Volvo)	163.198	11 44 811 90328832 94031590
50	Fijac. varios usos (ver Mercedes, VAG)	163.235	
50	Fijac. parachoques Astra G, Omega B, Vectra B, Zafira A, fijac. bajos carroceria Corsa A, Vectra A (ver Mercedes, VAG, Volvo)	163.305	23 17 703 90116376
50	Fijac. tapizados interiores Astra H, Zafira B '05->	163.910	22 65 571 90467391
50	Fijac. varios usos (ver Mercedes, Renault, Volvo)	163.926	01 67 935
50	Fijac. tapizados interiores Astra H, Meriva A '03->'10, Vectra C	164.060	73 36 931 13105583
50	Fijac. parachoque delantero Meriva B '10->, fijac. pasoruada Corsa C, fij. talonera puerta Vectra B	164.274	14 04 927 90319187

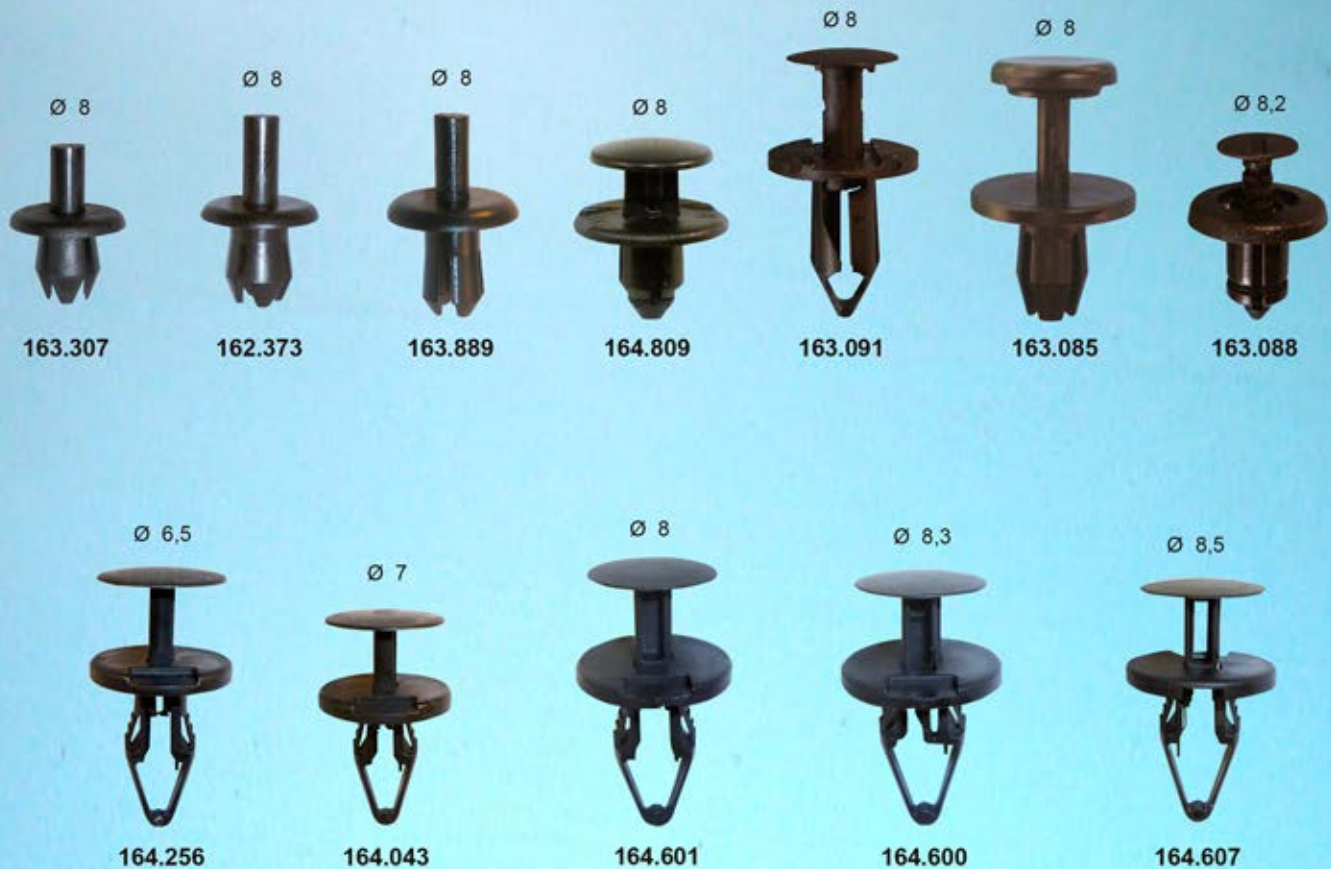

U.E.	DESCRIPCION	261	Ref. Adaptable
100	Fijac. parachoques, spoiler y pasoruada Adam, Ascona, Astra H y J, Calibra, Corsa C, D y E, Meriva A y B, Insignia, Signum, Vectra A y C, Zafira B, fijac. talonera puerta Astra J, Zafira C '12-> (ver Ford, Mercedes, PSA, VAG)	162.373	11 04 880 90087290
25	Fijac. panel trasero Corsa D, Vectra C (ver PSA)	163.085	18 10 850 90379945
50	Fijac. rejilla calandra Opel Movano B, fijac. soporte bandeja trasera Vivaro (ver Renault)	163.088	44 13 420 91169793
50	Fijac. parachoque delantero Antara '12-> (ver Chrysler, Ford, Land Rover, Renault, VAG)	163.091	48 03 228 21030249
100	Fijac. moldura pasoruada Astra H, Corsa B, C, D, E, Calibra, Meriva A y B, Signum, Tigra, Zafira B (ver Chevrolet)	163.307	17 19 245 90138810
50	Fijac. moldura pasoruada Adam, Astra F, G y H, Corsa D y E, Vectra B (ver Mercedes) fijac. parachoques Vectra C, Zafira B '05->	163.889	11 04 882 11 04 881 90450482
50	Fijac. parachoques y rejilla calandra Astra J, Mokka, Zafira C '12-> (ver Chevrolet, Ford)	164.043	48 11 301 11589289
25	Fijac. rejilla parabrisas "torpedo" y tapizados interiores Insignia '09->, Meriva B '10->, fijac. parachoque trasero Mokka	164.256	48 03 500 11589290
25	Fijac. pasoruada Astra J '09->, Insignia '09->, fijac. parachoque delantero y trasero Insignia '09->, fijac. bajos carroceria Astra J '09->, Cascada '13->, Insignia '09->, Zafira C '12->	164.600	02 12 951 11571109
25	Fijac. parachoques y pasoruada Astra J '09->, Mokka '13->, fij. otros usos interiores Corsa E '15->, Insignia '09->, Zafira C '12->, (ver Chevrolet, Ford)	164.601	18 16 589 11589293
25	Fijac. parachoques trasero y protector inferior parachoques delantero Mokka '13->, fijac. parrilla radiador Antara '12->	164.607	02 12 942 11589292
25	Fijac. parachoques trasero Mokka '13->	164.809	20 84 034 11612035



U.E.	DESCRIPCION	261	Ref. Adaptable
50	Tornillo Ø 4,8 x 18 (aro Ø 15), varios usos (ver varias marcas)	161.473	
50	Tornillo Ø 4,8 x 18 (aro Ø 15), varios usos (ver varias marcas)	161.474	
25	Tornillo Ø 6 x 20, fijac. parachoques delantero P-307 Restyling, y trasero P-407 y varios usos C1, C2, C3, C4, C5, Berlingo, DS3, Jumpy, Nemo, Xsara, Xsara Picasso, P-107, P-207, P-308, P-406, P-508, P-807, P-1007, P-3008, P-5008, Bipper, Expert, Partner (ver Opel, Renault)	161.721	6924.C1
25	Tornillo Ø 4,5 x 19 (aro Ø 12), fijac. plásticas varios usos (ver Fiat)	161.760	
25	Tornillo Ø 4,5 x 19 (aro Ø 16), fijac. parachoque, aletas y otros usos C2, C3, C4, C5, C8, Berlingo, Jumpy, Xantia, Xsara Picasso, P-206, P-207, P-307, P-308, P-407, P-508, P-3008, P-5008, Expert, Partner	161.761	6925.N0
50	Tornillo Ø 4,5 x 20, fijac. plásticas varios usos	161.803	6924.10
50	Tornillo Ø 4,5 x 25, fijac. plásticas varios usos	161.804	6924.C6
50	Tornillo Ø 4,5 x 30, fijac. plásticas varios usos	161.805	6924.E9
25	Tornillo Ø 6,3 x 20 (aro Ø 20), parachoques y bajos carroceria C1, P-107 (ver Toyota)	161.827	6822.92
25	Tornillo Ø 4,5 x 25 (aro Ø 18), fijac. pasoruada y parachoques C5 '08->, P-508	161.855	8565.66
25	Tornillo Ø 4,5 x 19, fijac. pasoruada y parachoques C3 '16->, C-Elysee, Jumpy IV '16, Spacetourer, P-301, P-2008, P-3008, P-5008, Expert IV '16, Traveller	161.857	9801024980



U.E.	DESCRIPCION	261	Ref. Adaptable
10	Remache Ø 7,5 x 28, fijac. cristal posterior C4, C4 Picasso, C5 '04-'08, P-206, Expert 3	161.481	6973.A4
10	Tornillo fij. parachoques Berlingo, C4, C5, C8, Jumpy, P-1007, P-206, P-307, P-307, P-807, Expert, Partner, fijac. aletas C4 '10, C5, P-407, P-3008, P-5008, fijac. faro Berlingo, Partner (ver VAG)	161.486	7427.23
100	Remache fijac. parachoque, elevelunas y revestimientos interiores -varios modelos-, fijac. rejilla parabrisas C4 (Eurocode 2732ASSHS)	161.606	6973.05
100	Remache fijac. varios usos	161.607	6973.47
50	Tornillo fijación protector motor/cárter y fijac. aletas y parachoques Berlingo, C2, C3, C4, C5, C8, Jumpy, P-206, P-207, P-807, P-1007, Expert, Partner	161.718	7030.16
25	Tornillo Ø 6 x 23 (aro Ø 18), fijac. aletas, parachoques y otros usos Berlingo, C2, C3, C4, C5, Xsara Picasso, P-106, P-106, P-306, P-308, P-406, P-407, P-607, P-1007, Partner (ver Fiat)	161.723	6922.H3
25	Tornillo Ø 6 x 18 (aro Ø 18), fijac. aletas, parachoques y otros usos Berlingo, C2, C3, C4, C5, Jumper, Jumpy, Xsara Picasso, P-106, P-106, P-306, P-308, P-406, P-407, P-607, P-1007, Boxer, Expert, Partner	161.730	6922.54
50	Remache Ø 2,4 x 5, fijac. molduras P-205, varios Citroen (ver Fiat, Ford, Opel, Renault, V.A.G.)	162.362	
5	Tornillo fijac. parachoques P-205 (corto)	162.435	7429.47
5	Tornillo fijac. parachoques P-205 (largo)	162.436	7429.48



U.E.	DESCRIPCION	261	Ref. Adaptable
25	Muelle fijac. manecilla elevaluas C-15	161.428	75 429 475
25	Fijac. junta cristal Visa, C-15	161.470	6943.65
25	Fijac. junta cristal P-205, P-309	161.471	6996.28 6992.15
50	Clip fijac. talonera puerta P-306, P-605 (ver Ford, Renault)	161.499	
50	Fijac. protector motor/cárter y fijac. aletas y parachoques Berlingo, C2, C3, C4, C5, C8, Jumpy, P-206, P-207, P-406, P-407, P-508, P-807, Expert, Partner	161.719	7030.18
50	Fijac. logotipos y seguro fijac. bisagra puertas Berlingo '09, C2, C3, C4, C5, Jumpy III, P-307, P-308, P-407, Partner '09, Expert III	161.720	9044.44
25	Fijac. protección bajos carrocería C5 '04 y '08->, C6, P-407, fijac. absorbedor parachoques delantero P-207	161.767	7030.19
25	Fijac. parachoque delantero Jumper '06, Boxer '06 (ver Fiat)	161.797	7518.GV
25	Tuerca especial redonda varios usos (Ø 6) (ver Ford, Renault)	162.375	
25	Boca metálica para fijaciones puerta P-205, P-306, P-309 (ver Fiat)	162.439	96 004 002 80
50	Clip fijac. pasoruedas ZX, Peugeot (ver Fiat, Renault, VAG)	162.442	
50	Fijac. (Ø 6) varios usos (ver Fiat, Ford, Renault)	162.465	
25	Tuerca con aro móvil (Ø 6), varios usos (ver Dacia, Ford, Opel, Renault, VAG)	162.711	
25	Tuerca con aro móvil (Ø 8), varios usos (ver Ford, Opel, Renault, VAG)	162.712	



163.312



163.313



163.672



163.314



163.705



163.315



163.713

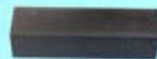

164.392

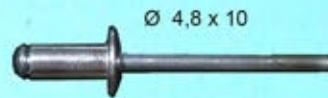

161.606



162.965



163.979



163.920

U.E.	DESCRIPCION	261	Ref. Adaptable
100	Remache fijac. rejilla parabrisas C4 (Eurocode 2732ASSHS)	161.606	6973.05
10	Base soporte parabrisas "torpedo" Nemo, Bipper (Eurocode 3359ASCH6B) (ver Fiat)	162.965	8123.A5
25	Fijac. moldura lateral parabrisas C2 (Eurocode 2731ASCSS)	163.312	8123.88
25	Fijac. moldura lateral parabrisas P-308, P-407 (Eurocode 6544ASCSS)	163.313	8123.89
25	Fijac. inferior moldura lateral parabrisas P-407 (Eurocode 6544ASCSS1B)	163.314	8123.90
25	Fijac. superior moldura lateral parabrisas P-407 (Eurocode 6544ASCSS2B)	163.315	8123.91
10	Fijac. moldura lateral parabrisas C5 '08->, P-508 (Eurocode 2740ASCSS)	163.672	8123.98
10	Fijac. moldura lateral parabrisas C6 (Eurocode 2733ASCSS)	163.705	8123.95
10	Fijac. moldura lateral parabrisas C4 '10->, C5 '07->, DS4, DS5, P-308 coupé cabriolet, P-508, P-3008 '08 y '16->, P-5008 '09 y '16-> (Eurocode 6560ASCMS1B)	163.713	8110.25 1622750180
10	Base soporte parabrisas "torpedo" Jumper III, Boxer III '06-> (ver Fiat)	163.920	8745.66
10	Fijac. moldura techo P-407 coupé	163.979	8321.31
10	Fijac. tope cala parabrisas Berlingo '08, C2, C3, C3 Picasso, C5, Jumpy III, Xsara, P-407, P-1007, Expert III, Partner '08 (Eurocode 6544ASCSS)	164.392	8735.76



163.594



163.082



163.373



163.379



162.967



164.462



163.717



163.300



163.912



164.294



164.129



164.171



162.446



163.645



163.316



162.633



162.978

U.E.	DESCRIPCION	261	Ref. Adaptable
50	Fijac. parrilla lavaparabrisas "torpedo" Xsara I '97->'00 (Eurocode 2725ASCHB1B)	162.446	6995.N7
100	Fijac. parrilla lavaparabrisas "torpedo" XM (Eurocode 2718ASCHB) (monta con 162.676)	162.633	6995.02 6999.CR
50	Fijac. rejilla parabrisas "torpedo" P-206 (Eurocode 6539ASCHB) (ver Renault)	162.967	8565.40 8565.63
50	Fijac. parrilla lavaparabrisas "torpedo" Xsara I y II (Eurocode 2725ASCHB)	162.978	6995.S0
50	Fijac. mold. lateral parabrisas C3 Pluriel (Euroc. 2730ASCTS1B) (ver Dacia, Renault, VAG, Volvo)	163.082	6991.S6
25	Remache fijac. rejilla parabrisas "torpedo" C1 '14->, P-108 (Eurocode 8011ASCH / 8010ASCR)	163.300	6822.P8
10	Base soporte parabrisas Berlingo, C4, Xantia, Xsara Picasso, ZX, Partner (Eurocode 2719ASCH)	163.316	8123.70 96 060 797
10	Fijac. moldura parabrisas P-1007 ('05->) (Eurocode 6547ASCHS)	163.373	8110.24
10	Fijac. moldura lateral parabrisas C4 Picasso '06 y '13-> (Eurocode 2735ASCMS) (ver Renault)	163.379	8123.96 7473.FL
25	Fijac. rejilla parabrisas C4 Picasso (Eurocode 6558LSCVFD) (ver Ford, Nissan, Opel)	163.594	9341.PF 1612108380
10	Base soporte parabrisas Citroën Saxo, Peugeot 106 Restyling (Eurocode 6520ASMH/2723ASCH)	163.645	8123.68
100	Remache fijac. moldura parabrisas P-206 y P-206+ (Eurocode 6539ASCHS)	163.717	6972.24
50	Fijac. rejilla parabrisas "torpedo" C4 Aircross, C-Crosser, P-4007, P-4008	163.912	6823.54
25	Fijac. moldura parabrisas C3 Pluriel, Xsara '97->'00 (Eurocode 2730ASCTS2B)	164.129	6991.G1
100	Fijac. moldura parabrisas-techo P-206 (Eurocode 6539ASCHDS)	164.171	8321.39
25	Fijac. soporte rejilla parabrisas "torpedo" Boxer, Jumper '06-> (ver Fiat)	164.294	8251.EP
50	Fijac. rejilla parabrisas "torpedo" Boxer III, Jumper III '06-> (Eurocode 6552ASCV) (ver Fiat)	164.462	8251.EN

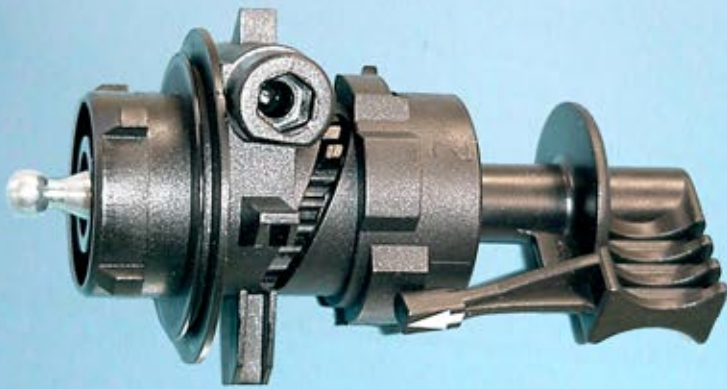

162.757



162.755



162.758



162.754



162.756



162.830

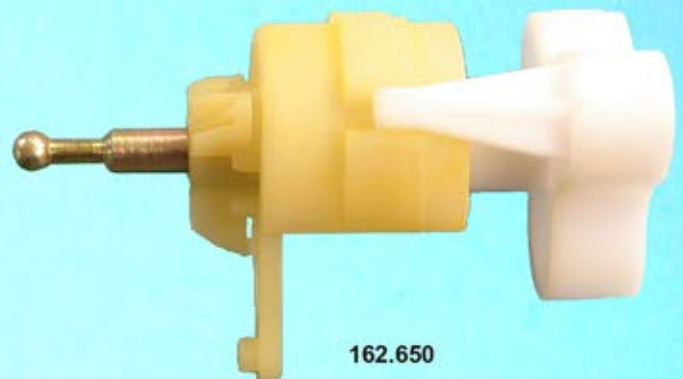

162.650

U.E.	DESCRIPCION	261	Ref. Adaptable
-	Regulador faro AX	162.650	95.634.217
10	Regulador faro C-15	162.754	75.5109.22
1	Kit regulador faro C-15 y AX	162.755	95.598.693
-	Regulador faro ZX, P-106, P-306	162.756	96.090.463
-	Regulador faro Jumpy I y II, ZX, P-106, P-306, Expert I y II	162.757	96.082.019 6224.79
-	Regulador altura faro Berlingo, Saxo, Evasion, P-106 restyling, P-306, P-405, P-406, P-806, Partner	162.758	6224.69
10	Casquillo sujeción faro ZX, P-106, P-306	162.830	6224.81

2617



171.434



171.433*



164.440 *- Dcho.
164.441 *- Izdo.

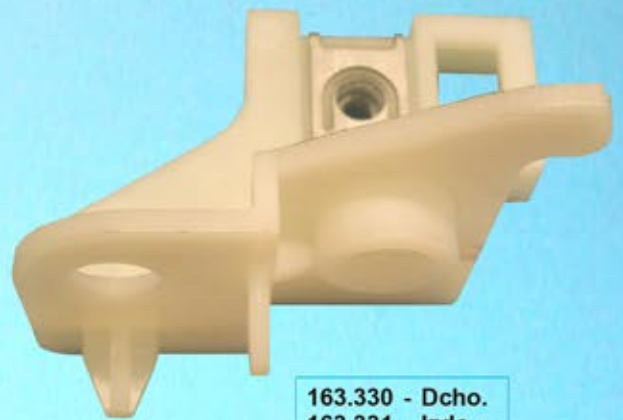

163.330 - Dcho.
163.331 - Izdo.

* (imagen NO a tamaño real)



162.831



162.832



163.631



163.633



164.624

U.E.	DESCRIPCION	261	Ref. Adaptable
10	Casquillo regulador faro AX, BX, ZX, P-106	162.831	95583069
10	Aro regulador faro ZX, P-106	162.832	95564656 6225.66
5	Soporte faro Derecho Xsara '00-'04	163.330	6212.58
5	Soporte faro Izquierdo Xsara '00-'04	163.331	6212.57
25	Tuerca fijac. pilotos traseros C3 Pluriel, C4, C5 '01->'08, Jumpy III, P-207, P-307, P-407, Expert III	163.631	6545.86
25	Tuerca fijac. pilotos traseros P-407 (desde OPR 10101)	163.633	6347.47
1	Kit soporte faro Derecho C4 '04->'10	164.440	6212.84
1	Kit soporte faro Izquierdo C4 '04->'10	164.441	6212.83
5	Fijac. faro DS5	164.624	9672905880
1	Regulador eléctrico faro Citroën C4 Picasso	171.433	6224.L1
1	Regulador eléctrico faro Berlingo, Evasion, Jumpy, Saxo, Xsara, Xsara Picasso, P-106, P-206, P-306 restyl., P-406, P-605, P-607, Expert, Partner (ver Fiat)	171.434	6224.C0



163.596*- Dcho.
163.597*- Izdo.



163.588*- Dcho.
163.589*- Izdo.



163.590*- Dcho.
163.591*- Izdo.



164.008*- Dcho.
164.009*- Izdo.



164.010*- Dcho.
164.011*- Izdo.

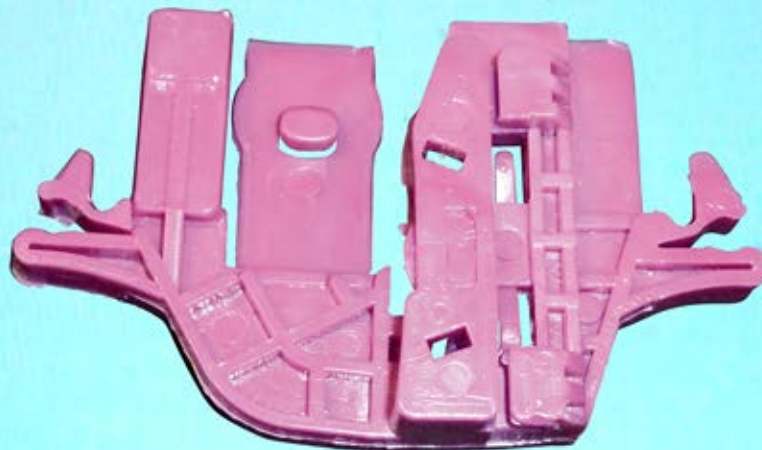

164.486 - Dcho.
164.487 - Izdo.

* (imagen 1/2 tamaño real)

U.E.	DESCRIPCION	261	Ref. Adaptable
1	Soporte cristal elevalunas delantero derecho Citroën Saxo, Peugeot 106	163.588	
1	Soporte cristal elevalunas delantero izquierdo Citroën Saxo, Peugeot 106	163.589	
1	Soporte cristal elevalunas delantero derecho Peugeot 306	163.590	
1	Soporte cristal elevalunas delantero izquierdo Peugeot 306	163.591	
1	Soporte cristal elevalunas delantero derecho Citroën ZX	163.596	
1	Soporte cristal elevalunas delantero izquierdo Citroën ZX	163.597	
1	Soporte cristal elevalunas derecho Jumper, Boxer '94->'06 (ver Fiat, Opel, Renault)	164.008	
1	Soporte cristal elevalunas izquierdo Jumper, Boxer '94->'06 (ver Fiat, Opel, Renault)	164.009	
1	Soporte cristal elevalunas derecho Jumper, Boxer '06-> (ver Fiat)	164.010	
1	Soporte cristal elevalunas izquierdo Jumper, Boxer '06-> (ver Fiat)	164.011	
1	Soporte cristal elevalunas derecho Jumpy, Expert '07-> (ver Fiat)	164.486	
1	Soporte cristal elevalunas izquierdo Jumpy, Expert '07-> (ver Fiat)	164.487	



163.662* - Dcho.
163.663* - Izdo.



164.369*
Dcho. / Izdo.



164.005
Dcho. / Izdo.



164.368*
Dcho. / Izdo.



164.367*
Dcho. / Izdo.

* (imagen 1/2 tamaño real)

U.E.	DESCRIPCION	261	Ref. Adaptable
1	Soporte cristal elevalunas delantero derecho Peugeot 406	163.662	
1	Soporte cristal elevalunas delantero izquierdo Peugeot 406	163.663	
1	Kit soporte cristal elevalunas delantero Citroën C5 '08->	164.005	
1	Kit soporte cristal elevalunas delantero Peugeot 206 (ver Renault)	164.367	
1	Kit soporte cristal elevalunas delantero Citroën C2, C3, Xsara, Xsara Picasso (ver Renault)	164.368	
1	Kit soporte cristal elevalunas delantero Berlingo, Partner '96->'08	164.369	



164.004*
Dcho. / Izdo.

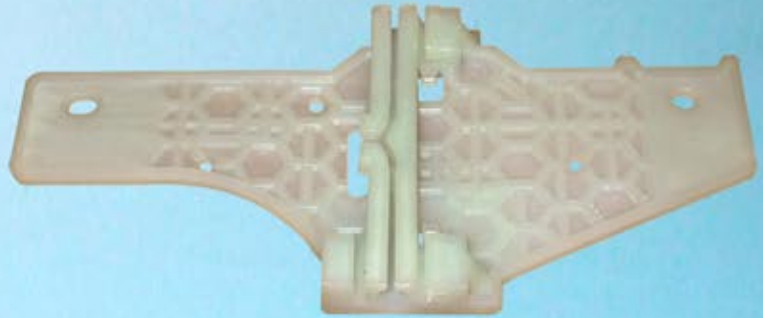

164.512*- Dcho.
164.513*- Izdo.



164.471
Dcho. / Izdo.

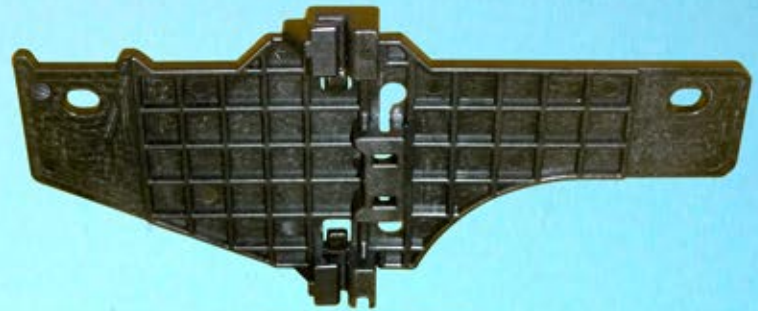

164.514*- Dcho.
164.515*- Izdo.



164.006 *- Dcho.
164.007 *- Izdo.

* (imagen 1/2 tamaño real)

U.E.	DESCRIPCION	261	Ref. Adaptable
1	Kit soporte cristal elevalunas delantero Peugeot 307	164.004	
1	Soporte cristal elevalunas delantero y trasero derecho Peugeot 407	164.006	
1	Soporte cristal elevalunas delantero y trasero izquierdo Peugeot 407	164.007	
1	Kit soporte cristal elevalunas trasero Peugeot 307 CC (ver Renault)	164.471	
1	Soporte cristal elevalunas delantero derecho Peugeot 207	164.512	
1	Soporte cristal elevalunas delantero izquierdo Peugeot 207	164.513	
1	Soporte cristal elevalunas delantero derecho Peugeot 307	164.514	
1	Soporte cristal elevalunas delantero izquierdo Peugeot 307	164.515	



164.400*- Dcho.
164.401*- Izdo.



164.484 - Dcho.
164.485 - Izdo.

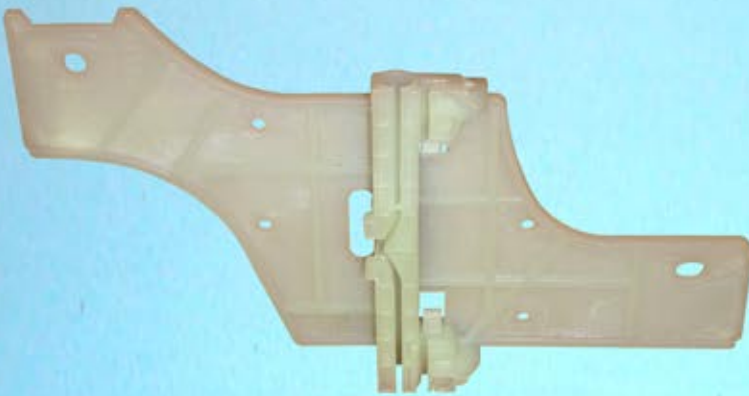

164.516*- Dcho.
164.517*- Izdo.



164.454*- Dcho.
164.455*- Izdo.



164.518*- Dcho.
164.519*- Izdo.

* (imagen 1/2 tamaño real)

U.E.	DESCRIPCION	261	Ref. Adaptable
1	Soporte cristal elevalunas derecho Berlingo, Partner '08->, delantero derecho Citroën C5 '08->	164.400	
1	Soporte cristal elevalunas izquierdo Berlingo, Partner '08->, delantero izquierdo Citroën C5 '08->	164.401	
1	Soporte cristal elevalunas trasero derecho Citroën C3 '01->'10	164.454	
1	Soporte cristal elevalunas trasero izquierdo Citroën C3 '01->'10	164.455	
1	Soporte cristal elevalunas derecho Nemo, Bipper '08-> (ver Fiat)	164.484	
1	Soporte cristal elevalunas izquierdo Nemo, Bipper '08-> (ver Fiat)	164.485	
1	Soporte cristal elevalunas delantero derecho Peugeot 508	164.516	
1	Soporte cristal elevalunas delantero izquierdo Peugeot 508	164.517	
1	Soporte cristal elevalunas trasero derecho Peugeot 508	164.518	
1	Soporte cristal elevalunas trasero izquierdo Peugeot 508	164.519	

261/



164.765 *- Dcho/Izdo.



164.724 *- Dcho/Izdo.



164.725 *- Dcho/Izdo.

* (imagen 1/2 tamaño real)

U.E.	DESCRIPCION	261	Ref. Adaptable
1	Kit (2 piezas) soporte parachoques delantero Peugeot 2008 '13->	164.724	1610145680
1	Kit (2 piezas) soporte parachoques trasero Peugeot 2008 '13->	164.725	1610116580
1	Kit (2 piezas) soporte parachoques delantero Peugeot 208 '12->	164.765	1607398380



164.762 *- Dcho/lzdo.



164.763 *- Dcho/lzdo.

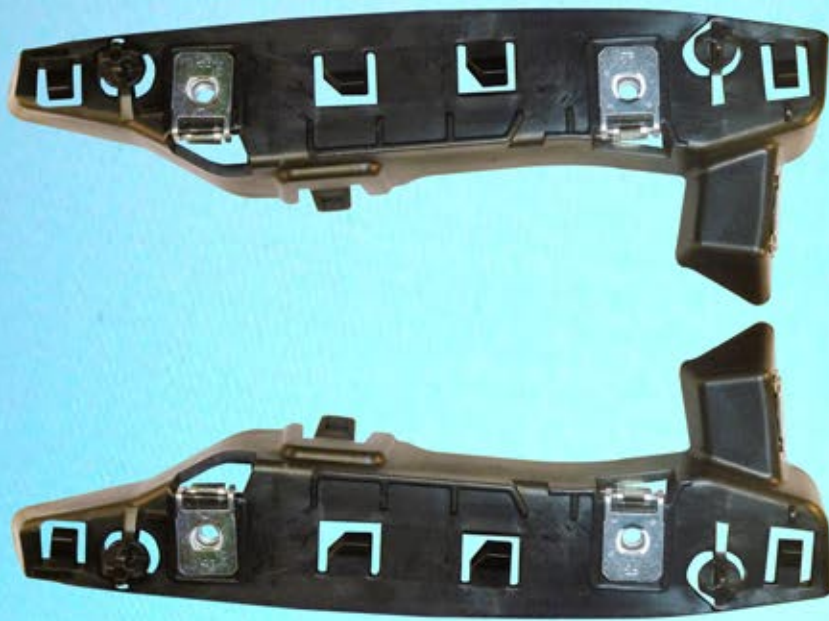

164.764 *- Dcho/lzdo.

* (imagen 1/2 tamaño real)

U.E.	DESCRIPCION	261	Ref. Adaptable
1	Kit (2 piezas) soporte parachoques delantero Citroën C3 (A51) '10->'16, DS3	164.762	7416.S9
1	Kit (2 piezas) soporte parachoques trasero Citroën C3 (A51) '10->'16	164.763	7416.S5
1	Kit (2 piezas) soporte parachoques delantero Citroën C4 (B7) '10->	164.764	7416.W8

261/

164.158



164.252



164.345 *- Izdo.



164.344 *- Dcho.



164.347 *- Izdo.



164.346 *- Dcho.

* (imagen 1/2 tamaño real)

U.E.	DESCRIPCION	261	Ref. Adaptable
10	Fijac. parachoque delantero C5 '08->, Jumpy III '07->, P-406, P-407, P-607, Expert III '07->	164.158	7437.12
10	Fijac. parachoque trasero C5 '08->	164.252	7427.58
1	Soporte parachoques delantero derecho C1, P-107	164.344	7416.88
1	Soporte parachoques delantero izquierdo C1, P-107	164.345	7416.87
1	Soporte parachoques trasero derecho C1, P-107	164.346	7416.86
1	Soporte parachoques trasero izquierdo C1, P-107	164.347	7416.85

261/

163.032

163.880

163.200

164.786

164.633

162.879

163.495

163.913

164.090

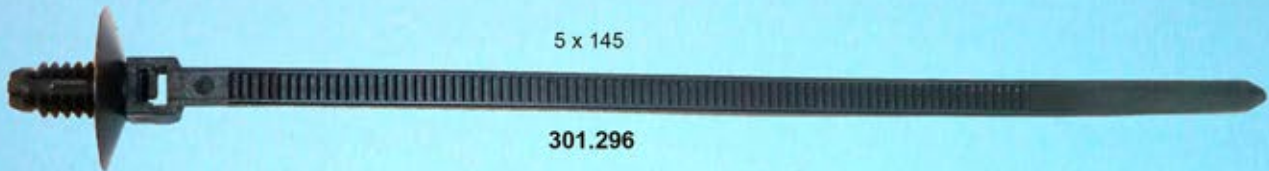
163.096

5 x 145

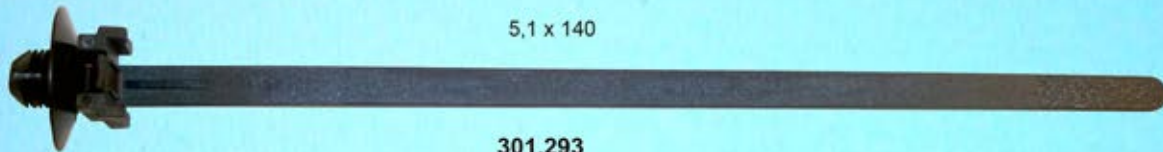
301.296

5,1 x 140

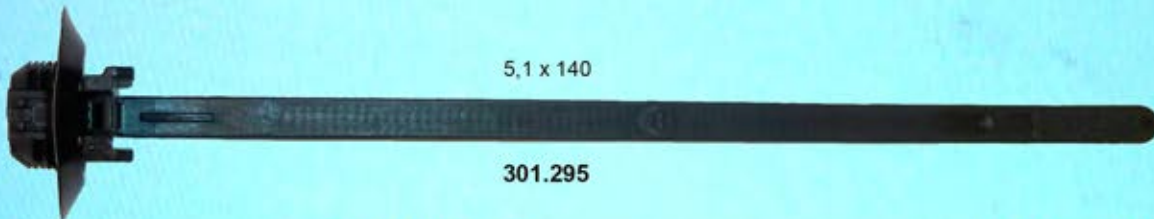
301.293

5,1 x 140

301.295

U.E.	DESCRIPCION	261	Ref. Adaptable
25	Fijac. insonorizantes AX, Berlingo, C8, Xantia, XM, Xsara, ZX, P-106, P-807, Partner	162.879	6992.V7
25	Fijac. tapa motor Berlingo, C4, C5, Xantia, Xsara, Xsara Picasso, P-206, P-306, P-307, P-406, P-607, Partner	163.032	0137.11
10	Fijac. rejilla radiador Boxer / Jumper III '06-> (ver Fiat)	163.096	7437.13
10	Soporte tapa motor Berlingo, C4, C5, Xantia, Xsara, Xsara Picasso, P-206, P-306, P-307, P-406, P-607, Partner	163.200	0137.23 0137.68
25	Fijac.insonorizantes capó Citroën Jumper III, Nemo, Peugeot Boxer III, Bipper (ver Fiat)	163.495	7979.H8
25	Fijac. tapa cubremotor Berlingo '09, C3 '09->, C4 '10->, C4 Picasso, C5 '08->,DS3, DS4, P-206, P-207, P-307, P-308, P-3008, P-5008, Expert III, Partner '09, fijac. pasoruera P-308 '14->	163.880	6986.A8
25	Fijac. retrovisor Berlingo, Partner, fijac. cableria bajo capó y otros usos -varios modelos- (ver Renault)	163.913	6555.N7 1610695980
10	Fijac. rejilla radiador Boxer / Jumper III '06->	164.090	7804.T6
10	Soporte filtro aire motores 1.6 HDI Berlingo, C2, C3, C3 Picasso, C4, C4 Picasso, Xsara Picasso, P-206, P-207, P-307, P-308, P-1007, P-3008, P-5008, Partner	164.633	1422.A3
25	Fijac. tapa motores 1.9D (DW8/DW8B) Berlingo '96->'08, Xsara I y II, P-206, P-306 restyling, Partner '96->'08	164.786	0137.04
50	Abrazadera (5,1 x 140) con soporte para fijac. cable eléctrico (todos los modelos) (ver Renault)	301.293	6980.99
50	Abrazadera (5,1 x 140) con soporte para fijac. cable eléctrico (todos los modelos)	301.295	6980.A3
25	Abrazadera (5 x 145) con soporte para fijac. cable eléctrico (todos los modelos)	301.296	6990.59



162.983



163.322



162.547



162.813



162.858



162.859



163.084



163.318

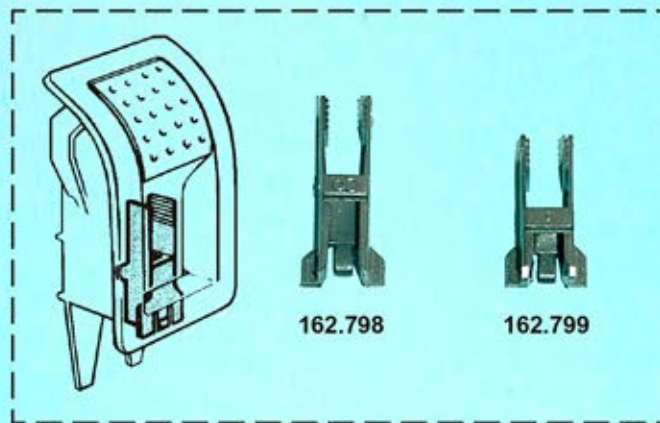

162.798

162.799

U.E.	DESCRIPCION	261	Ref. Adaptable
25	Fijac. varilla cerradura Peugeot	162.547	
10	Fijac. seguro puerta P-405, P-806 (ver Renault)	162.798	
10	Fijac. seguro puerta P-306	162.799	
25	Fijac. varilla cerradura Peugeot	162.813	
25	Fijac. varilla cerradura puerta Peugeot	162.858	
25	Fijac. varilla cerradura puerta AX, C5, C8, XM, ZX, P-106, P-205, P-206, P-306, P-309, P-405, P-406, P-605, P-607, P-807	162.859	9147.14 7903 079 144
25	Fijac. varilla cerradura Xsara I y II	162.983	6991.G0
25	Fijac. varilla apertura puerta Berlingo, C5 ->'08, C8, Jumpy I y II, Xantia, Xsara Picasso, P-206, P-306 restyling, P-807, Expert I y II, Partner	163.084	9147.32
50	Fijac. varilla cerradura Berlingo, Xantia, P-306, Partner (ver Renault)	163.318	9147.32 9147.04
25	Fijac. varilla cerradura C5 '01->'08, Xsara Picasso, P-206, P-306, P-406,	163.322	9147.21



162.814



163.323



163.869



163.728



163.723



163.729



163.885

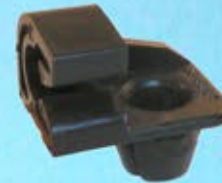

163.888



164.385



164.381



164.387



164.388



164.389



164.390

U.E.	DESCRIPCION	261	Ref. Adaptable
25	Fijac. varilla capó AX, C3, C4, C-15, Evasion, Saxo, P-106, P-306	162.814	6992.P3 7928.34
25	Fijac. varilla capó Xsara Picasso	163.323	6993.A1
25	Fijac. varilla capó C3 '09-> y '16->, C3 Picasso, C4 Cactus, C4 Picasso '13->, DS3, Jumpy IV '16->, Spacetourer, P-207, P-208, P-301, P-308, P-2008, P-3008, P-5008, Expert IV '16->, Traveller	163.723	7950.59
25	Fijac. varilla capó Berlingo '96->'02, C4 Picasso, ZX, P-307, Partner '96->'02	163.728	6997.A9
10	Fijac. varilla capó Berlingo '08->, C3 ->'08, C3 Pluriel, C4 ->'10, C4 Picasso, P-3008, P-5008, Partner '08->	163.729	7928.33
25	Fijac. varilla capó C4 '10->, P-206, P-308	163.869	7928.39
10	Fijac. varilla capó Evasion, Jumpy I y II, Expert I y II (ver Renault)	163.885	6995.X2
10	Fijac. varilla capó C3 Picasso, C8, Jumpy III, Xantia, P-206, P-207, P-307, P-807, Expert III	163.888	7928.31
10	Tope goma capó y portón AX, P-106, P-205, P-306 (ver Fiat, Renault)	164.381	
10	Tope goma capó Berlingo, C2, C5, Xsara Picasso, P-106, P-206, P-306, P-406, Partner	164.385	7908.67
10	Tope goma capó Berlingo '09->, C4 '04->'10, P-307, Partner '09->, Partner Tepee	164.387	8733.75
5	Tope goma capó (parte delantera del capó) C4 '10->, P-308, P-3008, P-5008, RCZ	164.388	8733.88
5	Tope goma capó (parte central del capó) C4 '10->, P-308, P-3008, P-5008, RCZ	164.389	8733.89
5	Tope goma capó DS3, C5 '04->, C6, P-206+, P-407	164.390	7908.F6

162.856

162.857

162.901

162.808

162.936

163.176

164.088

163.716

163.980

U.E.	DESCRIPCION	261	Ref. Adaptable
10	Fijac. mecanismo alzacrystal AX, Saxo, ZX, XM, P-106, P-306, P-406	162.808	
10	Fijac. cristal Saxo, P-106, P-306	162.856	9227.23
10	Fijac. cristal P-406	162.857	6999.93 6999.CW
10	Fijac. cristal Jumper, Boxer (ver Fiat)	162.901	9227.29
25	Fijac. junta cristal Saxo, P-106	162.936	9313.09
25	Fijac. cristal lateral puerta trasera C5 '01->'08 (ver VAG)	163.176	9227.51
25	Fijac. moldura techo Peugeot P-307	163.716	8321.26
25	Fijac. moldura techo Peugeot P-308	163.980	
10	Fijac. cristal C4, C4 Picasso, P-307 restyling, P-308, P-407	164.088	9227.52



162.984



162.692



163.015



162.802



162.801



162.800



163.404



163.638



162.349



162.347



162.825



162.964



162.680



163.374

U.E.	DESCRIPCION	261	Ref. Adaptable
10	Fijac. moldura lateral Visa, C-15	162.347	6992.T0 95571660
10	Fijac. moldura lateral Visa	162.349	95556738
25	Fijac. moldura lateral Evassion, P-806 (ver Fiat)	162.680	
10	Fijac. spoiler a parachoques C3, P-106, P-205, fijac. rejilla aire P-405	162.692	7420.47
50	Fijac. moldura lateral AX, C-15, ZX	162.800	9563 7051 6999.A2
10	Fijac. moldura pasoruada y bajopuerta AX	162.801	9563 7053
10	Fijac. moldura pasoruada y bajopuerta AX, Saxo, ZX	162.802	9563 7052
10	Fijac. moldura aleta delantera y capó C-15 moderna	162.825	9699 5446
10	Fijac. moldura puerta P-806, Citroen Evasión (ver Fiat)	162.964	96206697
50	Fijación rejilla de calandra Berlingo, C4, Evasion, Jumpy I y II, Xantia II, Partner, P-306, P-806, Expert I y II	162.984	6995.87
10	Fijac. rejilla de calandra delantera (bajo faro) P-306 restyling	163.015	7813.26
10	Fijac. moldura lateral puerta P-407 coupe	163.374	8565.55
25	Fijac. aletas delanteras P-307 y fijac. aletas y capó P-3008	163.404	7840.L7
25	Fijac. aletas delanteras Citroën C4, Peugeot P-307, P-308	163.638	7840.L6



163.944



163.871



163.870



164.536



164.531



162.804



162.430



162.876



162.370



162.501



163.052



163.873

U.E.	DESCRIPCION	261	Ref. Adaptable
50	Fijac. (con boca premontada) molduras BX, ZX, Xantia, Berlingo	162.370	9566 7895
100	Fijac. moldura parachoques delantero y trasero BX, P-205	162.430	7437.07
50	Fijac. aletas, tapizados y panel puerta Berlingo, Partner, ZX, fijac. moldura portón trasero Berlingo, Partner, XM (ver VAG)	162.501	6991.N4 + 6979.C6
100	Fijac. (Ø 9,5) moldura puertas, aletas, talonera puerta y otros usos Berlingo, C2, C5, C6, Xantia, Xsara I y II, Xsara Picasso, Saxo, P-206, P-306 restyling, P-307, P-406, P-407, Partner	162.804	8565.35
25	Fijac. moldura aletas y panel puerta Evasion, P-106, P-306, P-309 GTI	162.876	8565.20
25	Fijac. moldura lateral Jumper II y III, Peugeot Boxer II y III (ver Fiat)	163.052	8565.43
50	Fijac. moldura lateral puerta P-308, Jumpy IV '16->, Expert IV '16->	163.870	8565.62
50	Fijac. moldura aleta delantera C3 Picasso	163.871	8123.A9
25	Fijac. moldura lateral puerta Berlingo '09, Partner '09, Partner Tepee	163.873	8565.68
25	Fijac. moldura portón trasero C4 '04->'10, C5 '04->'08	163.944	8742.Q6
25	Fijac. moldura lateral puerta C4 Cactus	164.531	1613487180
25	Fijac. moldura lateral puerta C4 Cactus	164.536	1613487080

162.805

162.816

162.967

163.309

163.872

163.874

164.160

164.016

164.164

U.E.	DESCRIPCION	261	Ref. Adaptable
50	Fijac. rejilla calandra Evasion, Jumpy I y II, P-206, P-806, Expert I y II, fijac. retrovisor P-206, fijac. moldura aletas, puerta y talonera P-106 Restyling, P-306	162.805	6995.X3
50	Fijac. moldura aletas y puerta P-106 restyling, P-406 (ver Renault)	162.816	8565.34
50	Fij. aletas, molduras, panel puerta y parrilla lavaparabr. "torpedo" P-206 (Eurocode 6539ASCHB), fijac. aletas y moldura puerta Berlingo '09, C2, C3 Picasso y Pluriel, Evasion, Jumpy I y II, P-207, P-306, P-307, P-308, P-806, P-1007, Partner '09, Expert I y II, fijac. talonera puerta P-3008, fijac. parrilla radiador Saxo, fijac. tapizados maletero P-508 (ver Renault)	162.967	8565.40 8565.63
50	Fijac. moldura lateral C4, Jumpy III y IV, Expert III y IV, fijac. panel puerta Expert III, Jumpy III, fij. deflector trasero (alerón) C4	163.309	8565.48 8565.60
25	Fijac. moldura lateral puerta C4 Picasso, P-207 Coupé / Cabrio	163.872	8565.58
10	Fijac. moldura lateral puerta Citroën C6	163.874	8565.51
25	Fijac. moldura lateral puerta C5 '08->	164.016	8565.64
50	Fijac. moldura inferior puerta C6, y fijac moldura lateral puerta P-607	164.160	8565.42
25	Fijac. moldura puerta P-208	164.164	9676253780

163.161

162.980

162.803

163.378

163.379

162.229

162.981

162.855

162.372

162.667

161.421

162.379

163.501

163.876

164.559

U.E.	DESCRIPCION	261	Ref. Adaptable
50	Fijac. panel puerta y revestimientos interiores P-205	161.421	6992.93
100	Fijac. panel puerta y revestimientos interiores P-405 (ver Fiat, Renault)	162.229	
100	Fijac. panel puerta (con junta goma) AX, BX, C-15, Evasion, P-106, P-205, P-306, P-309, P-405, P-406, P-505, P-605, P-806 (ver Ford, Renault)	162.372	6992.51 6996.36 6995.A3 9615453880
50	Fijac. panel puerta y revestimientos interiores C-25, J5 (ver Fiat)	162.379	8336.40
50	Fijac. panel puerta (con junta goma) Evasion, Jumpy I y II, P-205, P-806, Expert I y II	162.667	6992.82
50	Fijac. revestimiento portón trasero y paneles laterales/puerta Berlingo, C3 Picasso y Pluriel, C5 '01->'04, Saxo, XM, Xsara I y II, Xsara Picasso, P-406, Partner	162.803	6990.50
50	Fijac. panel puerta Evasion, P-405, P-605, P-806	162.855	6992.J4 96048533
50	Fijac. tapizados interiores P-106, P-206, P-307, fijac. tapizados portón trasero C4 Picasso, fijac. rejilla calandra C8	162.980	6991.E8 6966.39
50	Fijac. panel puerta P-406	162.981	6995.Y5
25	Fijac. panel puerta C1, P-107 (ver Lexus, Mitsubishi, Subaru, Suzuki, Toyota)	163.161	6822.LL
10	Fijac. portón trasero P-407 SW, tapiz. interiores C6, moldura parabrisas C8, P-807 (ver Renault)	163.378	8742.G2
10	Fijac. panel puerta trasero C6, P-407 (ver Renault)	163.379	8123.96 7473.FL
50	Fijac. tapizado panel lateral Jumpy I y II, Expert I y II, fijac. tapizado techo C4 Picasso, Jumpy III, Expert III	163.501	8565.46
25	Fijac. tapizados portón trasero C4 Picasso '13->, Jumpy IV '16->, DS3, DS4, DS5, Spacetourer, P-308, P-3008, P-5008, Expert IV '16->, Traveller (ver Chevrolet, Opel, Renault)	163.876	8748.QT
25	Fijac. tapizados puerta lateral Jumpy IV '16->, Expert IV '16->, Spacetourer, Traveller fijac. tapizados interiores P-308 '13->	164.559	9802867380



164.599



164.430



163.594



163.083



163.669



164.621



163.234



163.082



163.453



163.727



163.708



162.967

U.E.	DESCRIPCION	261	Ref. Adaptable
50	Fij. panel puerta P-206 y fijac. tapizados maletero P-508 (ver Renault)	162.967	8565.40 8565.63
50	Fijac. panel y revestimientos puerta Berlingo, C2, C3, C4, C4 Picasso, C5 '01->'08, C6, C8, Xsara Picasso, P-206, P-207, P-306, P-307, P-308, P-406, P-407, P-607, P-807, P-1007, Partner, fijac. aletas P-206, P-207 y fijac. moldura lateral parabrisas C3 Pluriel (Eurocode 2730ASCTS1B) (ver Dacia, Renault, VAG, Volvo)	163.082	6991.S6
25	Fijac. panel puerta y tapizados C2, C4 Picasso, C8, Jumpy III, P-207, P-407, P-807, Expert III, fij. aletas delanteras Berlingo '09, Jumpy III, Partner '09, Expert III, fij. parachoque trasero C3 Picasso (ver Fiat, Renault)	163.083	6991.Y8
50	Fijac. tapizados portón P-307, fijac. tapizados interiores P-307, P-607, fijac. capó P-607, fijac. caja corrector faros C4, RCZ	163.234	6991.T3
50	Fijac. panel puerta lateral deslizante Expert III, Jumpy III, fijac. moldura lateral Expert III, Jumpy III, y fijac. tapizados maletero P-308 '14->, P-508 (ver Dacia, Fiat, Renault)	163.453	8335.TE
25	Fijac. panel puerta C3 '10->, C3 Picasso, C4, C4 Picasso, DS3, Jumpy 3, P-307, P-308, P-3008, P-5008, Expert 3, fijac. evacuador rejilla parabrisas C4 Picasso (Eurocode 6558LSCVFD), fijac. tapiz. interiores, portón trasero y retrovisores Berlingo '09, C5 '08->, P-508, Partner '09, fijac. tapiz. interiores P-407 (ver Ford, Nissan, Opel)	163.594	9341.PF 1612108380
25	Fijac. panel puerta Citroën C3 '16->, C4 '10->, C4 Picasso '13->, C4 Cactus, C-Elysee, DS4, DS5, P-208, P-301, P-308 '14->, P-508, P-2008, P-3008, P-5008 (ver Opel, Renault)	163.669	9345.ZN
50	Fijac. panel puerta C3 '10->, C5 '08->, DS3, P-206 Coupé/Cabrio, P-207 Coupé/Cabrio, P-307 Coupé/Cabrio, P-308, P-607 restyling, P-1007, fijac. tapizados interiores C3 Pluriel, C4 Picasso, fijac. rejilla parabrisas C3 Pluriel	163.708	6991.S9
50	Fijac. tapizados interiores Berlingo '09->, C3 '09->, C4 '10->, C4 Cactus, C4 Picasso, DS3, P-5008, Partner '08, RCZ (Eurocode 6558BSCV) (ver Dacia, Mini, Renault)	163.727	8337.FC 6991.Z1
25	Fijac. panel puerta delantera C1 '14->, P-108 (ver Toyota)	164.430	1612455780
50	Fijac. panel puerta delantera y trasera C1 '14->, P-108 (ver Toyota)	164.599	1612454480
25	Fijac. tapizados portón trasero P-308 '13->	164.621	1613702580

261/

164.790

164.791

162.987

162.848

162.849

162.850

162.714

162.633

162.978

164.652

163.905

U.E.	DESCRIPCION	261	Ref. Adaptable
100	Fijac. panel puerta y revestimientos interiores AX, Xantia, XM, Xsara I y II, ZX, P-306, P-309, Expert fijac. parrilla lavaparabrisas "torpedo" XM (Eurocode 2718ASCHB) (monta con 162.676)	162.633	6995.02 6999.CR
50	Fijac. panel puerta P-306, P-406 (ver Fiat)	162.714	6995.W1
25	Fijac. panel puerta Xantia I y II, ZX	162.848	96 126 454
25	Fijac. panel puerta Xantia, ZX	162.849	96 120 786
25	Fijac. panel puerta Xantia I y II	162.850	96 139 474
50	Fijac. revestimientos interiores puerta AX, Evasion, Expert I y II, P-806 (monta con 162.446) fijac. parrilla lavaparabrisas "torpedo" Xsara I y II (Eurocode 2725ASCHB)	162.978	6995.S0
50	Fijac. panel puerta Xsara I y II	162.987	6991.F4
10	Fijac. panel puerta Citroën Jumpy III, Peugeot 207, Expert III	163.905	9341.23
10	Fijac. tapizados portón trasero DS5	164.652	9673899680
10	Fijac. tapizados interiores (pilar A) C4 Cactus, P-208, P-2008	164.790	9673943080
25	Fijac. tapizados interiores (pilar A) C4 Cactus, P-208, P-2008	164.791	9673943180



U.E.	DESCRIPCION	261	Ref. Adaptable
100	Fijac. revestim. interiores AX, BX, ZX, XM, Xantia, P-106, P-205 (monta con 162.446)	162.447	7903 077 167
100	Fijac. aletas delanteras y traseras y tapizados interiores Berlingo, BX, C5, C8, Evasion, Saxo, Xantia, XM, Xsara II, Xsara Picasso, Jumpy I y II, P-106, P-306, P-405, P-406, P-806, P-807, Expert I y II, Partner, y fijac. rejilla lavaparabrisas Xantia I y II	162.806	6966.34 6992.95
100	Fijac. panel puerta Xantia	162.883	8326.N4
25	Fijac. tapizados interiores Xantia I y II, ZX, P-407 (ver Dacia, Ford, Renault)	162.941	9699575280
50	Fijac. insonorizante capó Berlingo, C2, C3, C3 Picasso y Pluriel, C5 '01->'04, Saxo, Xantia, XM, Xsara I y II, Xsara Picasso, P-206, P-207, P-1007, Partner, Ranch	163.017	6995.V6
50	Fijac. revestimientos interiores y tapizados puerta Berlingo, Jumpy, Saxo, P-1007, P-106, P-205, P-306, P-806, Expert -todos-, Partner	163.086	6966.33
25	Fijac. tapizados portón trasero C5 '01->'04, Xsara Picasso	163.136	8748.Q5
10	Fijac. aislamiento capó Citroën C1, Peugeot 107 (ver Lexus, Toyota)	163.258	6822.N5
100	Fijac. aletas delanteras AX, BX, C-15, Saxo, Xantia, P-106, fij. aletas traseras P-106, P-206, P-406, fijac. revestimientos interiores AX, C-15, Berlingo, Xantia, XM, Xsara I y II, ZX, P-306, Partner, fijac. deflector P-306, y fijac. capó C4, C8, Jumpy III, ZX, P-106, P-306, P-307, P-807, Expert III	163.308	6992.C6
50	Fij. refuerzo parachoques delantero C5, C6, P-407, fijac. parachoques trasero P-407, fijac. revestim. interiores Jumpy III, Expert III	163.317	7437.10
25	Fijac. portón trasero y retrovisor C5 '01->'08, fijac. aletas delanteras ZX, fijac. otros usos Berlingo, C4 '11->, P-308	163.326	6547.20
100	Fijac. tapizados interiores Berlingo '09, C3, C3 Picasso y Pluriel, P-307, P-407, Expert III, P-1007, P-3008, Partner '09	163.386	7588.VX
10	Fijac. tapizados interiores Berlingo '09->, C2, C3, C4, C4 Picasso, P-206, P-207, P-307, P-308, P-1007, Partner '09->	164.089	7584.AQ



U.E.	DESCRIPCION	261	Ref. Adaptable
100	Fijac. tapicería Berlingo, P-106, P-206, P-307, P-405, P-605, Partner, fijac. capó P-206, P-307 (Negro) (ver Opel, Renault)	162.221	8964.57
100	Fijac. tapicería Berlingo, P-106, P-405, P-605, Partner (Gris) (ver Opel, Renault)	162.222	
50	Fijac. revestimientos interiores Peugeot - varios -	162.441	6996.45
100	Fijac. revestimientos interiores Citroen/Peugeot (ver Mercedes, Renault)	162.453	6992.66
100	Fijac. tapizados AX, BX, C-15, ZX, parachoques trasero Xsara II, P-306, fijac. aletas delanteras ZX, fijac. cablería capó C4 Picasso (ver Renault)	162.454	6995.15
50	Fijac. revestimientos interiores AX, C-15, Saxo, P-106, P-205, P-206, P-306, P-309, P-405, P-406, P-605	162.657	6983.17
100	Fijac. revestimiento interior AX, BX, ZX (ver Fiat)	162.660	
100	Fijac. tapizados interiores AX, ZX, Saxo, Xantia, Berlingo, Evasion, P-106, Partner	162.935	6966.40
25	Fijac. tapizados interiores C8, Jumpy III, P-807, Expert III	163.087	7584.28
50	Fijac. revestimientos interiores traseros C4 '04->'10 y '11->, Evasion, P-206, P-308, P-405, P-806, P-1007, fij. rejilla parabrisas P-309, fij. tirante motor C4, C4 Picasso, P-307, P-308, P-3008, P-5008 fijac. cablería C4, Xsara Picasso, P-308, P-406, fijac. insonorizante capó Berlingo, Partner ->'03	163.630	6992.78



U.E.	DESCRIPCION	261	Ref. Adaptable
50	Fijac. revestimientos interiores P-205, P-309	162.440	6992.31
50	Fijac. aletas delanteras y tapizados interiores Boxer I, II y III, Jumper I, II y III (ver Fiat)	162.512	8331.38 8748.W4 8748.Y6
50	Fijac. tapizados piso Xantia I y II, ZX (ver Renault)	162.656	7518.N8
100	Fijac. tapizados interiores P-307 (ver Mercedes, Nissan, Renault)	162.934	
50	Fijac. pasoruada P-306, fijac. tapizados P-307, P-308, fij. insonorizante tablero C4, P-106, fijac. luna puerta C4 '11	163.201	8964.77
50	Fijac. pasoruada Berlingo, Saxo, Xsara II, Partner, fij. parachoque trasero C3, fijac. aletas traseras Saxo, P-106, fijac. tapizados alfombra maletero C4, Saxo, P-106, P-206, P-207, P-307, P-406	163.886	7568.H0
25	Fijac. panel puertas traseras P-106 restyl., fijac. tapizados alfombra maletero P-406, fijac. parachoque trasero P-605	163.887	6995.40
50	Fijac. tapizados interiores Jumper, Boxer '02->'06 y '06-> (ver Fiat, Ford)	164.059	8748.Y6
50	Fijac. pasoruada Berlingo '02->'08, Saxo, Xsara II, Xsara Picasso, Partner '02->'08, fijac. tapizados interiores C5, Xsara, P-508 (ver Ford)	164.092	7518.C0
10	Fijac. insonorizante capó C4 Aircross, C-Crosser, P-4007, P-4008 (ver Mitsubishi)	164.239	6823.CX
25	Fijac. soporte rejilla parabrisas "torpedo" Jumper, Boxer '06-> (ver Fiat)	164.294	8251.EP



U.E.	DESCRIPCION	261	Ref. Adaptable
50	Boca fijac. revestimientos AX, Berlingo, C8, C6, Evasion, Jumpy I y II, XM, Xantia, Xsara, ZX, P-306, P-806, P-807, Expert I y II, Partner, fijac. aletas P-406 Coupé (monta con 162.447 y 162978)	162.446	6995.N7 9609212380
50	Boca (Ø 8) para panel puerta ZX (ver Renault)	162.675	
50	Fijac. gomas puerta y capó Saxo, Xsara, Xantia, Berlingo, Evasión, Peugeot - varios modelos - (ver Fiat)	162.880	6992.K8 6999.A3
50	Fijac. gomas puerta y capó C8, Xsara I y II, Xsara Picasso, P-406, P-807 (ver Renault)	163.081	6997.86
50	Fijac. junta puerta P-307, P-607 (ver Ford, Renault)	163.135	6990.E0 9639570480
50	Fijac. junta portón trasero Jumper / Boxer I, II y III, fijac. moldura vierteaguas y fieltro capó P-307, P-406	163.179	8710.67 8710.84
50	Boca (Ø 8,2) fij. soporte para choques C3 Picasso, P-207, fijac. panel puerta Xsara II, P-106, P-406, fijac. panel portón trasero C3, P-3008, fijac. panel techo C8, Evasion, Jumpy, P-806, P-807, Expert, fij. pilotos traseros Saxo, Xantia, Xsara Picasso, P-206, fij. separador tabique Berlingo y Partner '09	163.376	6992.S2
25	Boca (Ø 9) fijac. panel puerta Jumpy I, II y III, Expert I, II y III, fij. detector presión ruedas C8, P-807	163.632	8565.47
50	Fijac. junta goma puerta delantera C5 '08->, delantera y trasera P-308, trasera P-3008, P-5008	163.715	9025.J8
50	Fijac. pasarueda Berlingo, C4 Picasso, Saxo, Xsara II, Xsara Picasso, P-106, P-205, Partner, fijac. para choque C3 y tapizados interiores varios modelos	164.130	6983.06
100	Fijac. moldura techo P-206, P-307, otros usos P-205, P-605	164.171	8321.39
50	Fijac. junta goma puerta C4 Aircross, C-Crosser, C-Zero, P-4007, P-4008, Ion (ver Mitsubishi)	164.732	6822.ZA
50	Fijac. junta goma puerta C4 '10->, DS4, DS5	164.733	9676050480
50	Fijac. junta goma puerta C4 Aircross, C-Crosser, P-4007, P-4008	164.780	6823.JY



U.E.	DESCRIPCION	261	Ref. Adaptable
50	Boca (Ø 10) para revestimientos interiores ZX, Xantia, P-106, P-205, P-306, P-405, P-605 (ver Renault)	162.648	
50	Boca (Ø 8,2) para panel puerta Berlingo, Evasion, Jumpy I y II, Xsara Picasso, P-106, P-205, P-306, P-309, P-405, Expert I y II, Partner (monta con 162.633)	162.676	8565.17
50	Junta plástica fijac. protectores motor Evasion, Jumpy I y II, Xsara II, P-806, P-807, Expert I y II, fijac. parachoques C5 '04 y C8	163.375	7030.17
25	Fijac. pasoruada Jumper, Boxer (ver Fiat)	163.493	
10	Fijac. rejilla de calandra delantera Berlingo '02->'08, Partner '03->'08, fijac. deflector rejilla parabrisas P-306	163.634	6995.N3
25	Fij. protector bajos carrocería Berlingo '96->'08, Xsara, Xsara Picasso, ZX, P-306, Partner '96->'08	163.724	6990.81
25	Fij. protector bajos carrocería Berlingo '96->'08, Xsara, Xsara Picasso, ZX, P-306, Partner '96->'08, fij. plancha bajo salpicadero AX, Xantia I y II, P-206 (monta junto con 163.724)	163.725	8220.EF
10	Fijac. parachoques delantero Berlingo, Partner '09->, fijac. protector bajos carrocería C3 '09->, C3 Picasso, DS3, C4 '10->, C4 Picasso, C8, Jumpy I, II y III, P-207, P-607, P-806, P-807, Expert I, II y III, RCZ	163.731	7481.GP
1	Botón abridor portón Jumper '06->'11, Boxer '06->'11 (ver Fiat)	164.522	8728.30
-	Tirante bandeja posterior P-106 (long.total 340 mm.)	182.308	

7 x 7
Tornillo Ø 3,5



162.237

7 x 7
Tornillo Ø 4,2



162.244

7 x 7
Tornillo Ø 4,5



164.129

8 x 8



163.883

8 x 8
Tornillo Ø 4,8



162.887

8,2 x 8,2
Tornillo Ø 4,2



162.985

9 x 9
Tornillo Ø 5,5



163.256

9 x 9
Tornillo Ø 5,5



164.738

9 x 9
Tornillo Ø 5,5



163.165

10 x 15
Tornillo Ø 6,3



162.518

10 x 15
Tornillo Ø 6,3



162.371

10,8 x 11,2
Tornillo Ø 6,35



163.377

Tornillo Ø 5



164.102

U.E.	DESCRIPCION	261	Ref. Adaptable
100	Fijac. tapizados traseros, portón trasero P-307, P-308, P-406, P-3008, P-5008, fijac. frontal ordenador C4 '11->	162.237	6987.A7
100	Fijac. revestimientos interiores, parachoques y aletas AX, Berlingo, BX, C3, C4, C4 Picasso, C5, C-15, Jumpy I, II y III, Saxo, Xantia, XM, Xsara, ZX, P-206, P-207, P-306, P-307, P-308, P-407, P-508, P-3008, P-5008, Expert I, II y III, Partner (ver Fiat, VAG)	162.244	6992.G2
25	Fijac. apoyabrazos AX, BX, XM, ZX, P-106, P-205, P-405	162.371	6992.87
25	Fijac. apoyabrazos AX, BX, ZX, Evasion, P-106, P-205/309, P-806	162.518	7903 081 055
10	Boca fijac. tapiz. interiores, alfombras piso Boxer / Jumper I y III Bipper / Nemo (ver Fiat)	162.887	6991.P2
50	Fijac. panel puerta Jumpy III, Expert III, fijac. aletas P-206, P-406, fijac. parachoque trasero P-407	162.985	7136.A5
25	Fijac. pasoruada delantero C1 '14->, P-108 (ver Lexus, Toyota)	163.165	B000951180
25	Fijac. protección bajos carrocería C1 '06 y '14->, P-107 y P-108 (ver Toyota)	163.256	6822.J7
50	Fijac. - varios usos - Berlingo, C3, C3 Picasso y Pluriel, C4, C4 Picasso, C5, Xantia, P-205, P-207, P-309, P-607, P-1007, Partner	163.377	6991.39
10	Taco fijac. tapizados interiores P-3008, P-5008 (ver Dacia, Renault)	163.883	7427.46 9675434480
25	Fijac. varios usos P-207, P-3008, P-5008 (ver Renault)	164.102	
25	Fijac. parachoque trasero Peugeot 307	164.129	6991.G1
25	Fijac. pasoruada C1, P-107 (ver Toyota)	164.738	6822.QP



U.E.	DESCRIPCION	261	Ref. Adaptable
50	Fijac. varios usos Berlingo, C4, C4 Picasso, C5, C6, C8, Evasion, Jumpy, Saxo, Xantia, XM, Xsara, Xsara Picasso, P-106, P-205, P-206, P-207, P-308, P-309, P-405, P-406, P-407, P-605, P-607, P-806, P-807, P-1007, Expert I, II y III, Partner (ver Fiat, Renault)	162.523	6992.80
50	Fijac. "torpedo" parabrisas y guarnecidos interiores Bipper, Nemo (ver Fiat)	162.892	8251.FC
25	Fijac. revestimientos interiores y varios usos Jumper, Boxer (ver Fiat)	162.902	
25	Fijac. - varios usos - Berlingo, Jumpy I y II, Xantia, Xsara I y II, Xsara Picasso, P-306, P-406, P-607, P-806, Expert I y II, Partner	162.982	7410.E2
25	Fijac. (con inserto tornillo Ø6) tapizados interiores Jumpy III, Expert III '07-> (ver Renault) fijac. bajos carroceria C3 Picasso, P-207	163.214	6943.53
25	Fijac. revestim. interiores Berlingo '09, C3, C3 Picasso, C4, C4 Picasso, C5 '08->, DS3, Evasion, Jumpy I, II y III, Xantia, Xsara, Xsara Picasso, P-206, P-207, P-308, P-806, P-5008, Expert I, II y III, Partner '09, fijac. rejilla lavaparabrisas Berlingo, C5 '01->'08, Jumpy III, Expert III, Partner, fijac. parachoques Berlingo '09, C2, C3, DS3, Evasion, P-207, P-308, P-806, P-1007, Partner '09, (ver Dacia, Fiat, Opel, Renault)	163.222	6997.96
50	Taco fijac. parachoques delantero C3, fijac. tapizados interiores Berlingo '09->, C4 '11->, C5 '08->, Partner Tepee '09->, P-207 coupé, P-308, P-508, P-3008, RCZ (ver Renault)	163.502	
10	Fijac. parachoques Berlingo '02->'08, C3 ->'04, Xsara, Xsara Picasso, P-1007, Partner '02->'08, fijac. rejilla parabrisas («torpedo») P-306	163.635	6995.N4
25	Fijac. moldura vierteaguas trasero P-308	163.730	8525.NS
50	Fijac. parachoques delantero C3 '01->'05, fij. tapizados interiores Berlingo '09, C5 '08, DS4, P-207, P-308, P-407, P-508, P-3008, Partner Tepee, RCZ (ver Dacia, Renault)	163.881	7568.NZ
10	Taco fijac. panel puerta C3 '16->, C4 '10->, C4 Cactus, C4 Picasso '13->, C-Elysee, DS4, Jumpy IV '16->, Spacetourer, P-208, P-301, P-308 '14->, P-2008, P-3008, P-5008, Expert IV '16->, Traveller, fijac. tapiz. interiores C3 '10->, C4 Picasso '13->, DS3, Jumpy IV, P-508, Expert IV '16-> (ver Fiat, Opel, Renault)	163.882	8794.ZA

261/



162.431



163.717



162.456



163.299



163.303



162.624



163.485



163.487



162.481



163.486



162.389



162.906



162.424



163.300



162.979



164.678

U.E.	DESCRIPCION	261	Ref. Adaptable
100	Remache fijac. varias aplicaciones Citroen (ver Fiat)	162.389	6972.02
50	Remache fijac. varias aplicaciones Citroen, P-309 (ver Fiat, Mercedes, Renault, VAG)	162.424	
100	Remache fijac. contorno puerta XM, P-205, P-405, P-504 (ver BMW, Mercedes, Opel, VAG)	162.431	6972.07
50	Remache fijac. revestimiento interior Citroen, Peugeot (ver BMW, Mercedes, Renault, VAG)	162.456	
50	Remache fijac. varios usos AX, XM, Xantia (ver Renault)	162.481	
100	Remache fijac. para choques Citroen/Peugeot (ver Fiat)	162.624	6973.46
25	Remache fijac. varios usos AX, Berlingo, BX, C2, C3, C3 Picasso, C4, C4 Picasso, C5, C6, Jumpy I y II, Saxo, Xantia, XM, Xsara, P-106, P-206, P-306, P-307, P-308, P-405, P-406, P-407, P-508, P-607, P-806, P-1007, P-3008, P-5008, Expert I y II, Partner	162.906	1539.16
50	Remache fij. pasoruada, insonoriz. capó y rejilla calandra C8, Jumpy, P-206, P-307, P-807, Expert, fijac. panel puerta, tapizados, para choques, bajos carrocería C3 '10->, C3 Picasso y Pluriel, C4, C4 Picasso, C8, DS3, Jumpy III, Xsara, P-106, P-207, P-306, P-307, P-308, P-406, P-807, P-3008, P-5008, Expert III, fij. capó Berlingo '09, C5 '08, Evasion, P-407, P-806, Partner '09 (ver Fiat)	162.979	6997.T2 6997.83
50	Remache fijac. revestimientos interiores Jumpy (negra) (ver Fiat)	163.299	
25	Remache fijac. rejilla parabrisas "torpedo" C1 '14->, P-108 (ver Mitsubishi, Subaru, Suzuki, Toyota, Volvo)	163.300	6822.P8
50	Remache fijac. para choques trasero P-307, tapiz. interiores puertas Jumpy I y II, Expert I y II (gris) (ver Fiat)	163.303	8748.C2
50	Remache fijac. para choques, tapizados interiores y otros usos Berlingo, C2, C3 '10->, C3 Picasso, C4, C4 Picasso, C5, C6, C8, DS3, Jumpy, Xantia, Xsara, Xsara Picasso, P-207, P-307, P-308, P-406, P-407, P-607, P-806, P-807, P-3008, P-5008, Expert I, II y III, Partner (ver Smart, VAG)	163.485	6555.LE
50	Remache fijac. varios usos C3, C4, C5, C8, P-307, P-607, P-807 (ver Renault)	163.486	
50	Remache fijac. varios usos C3, C4, C5, C8, P-307, P-607, P-807 (ver Mercedes, Renault)	163.487	
100	Remache fijac. moldura parabrisas P-206 y P-206+, fijac. junta puertas P-406 (ver Renault) fijac. indicador estacionamiento C5	163.717	6972.24
50	Remache fijac. pasoruada delantero C1 '14->, P-108 (ver Toyota)	164.678	B000951280

261/



163.529



163.167



162.373



163.085



163.014



163.166



163.344



162.341



163.127



163.963



163.981



163.358



162.708

U.E.	DESCRIPCION	261	Ref. Adaptable
100	Remache fijac. aletas delanteras Saxo, P-106, P-605, fijac. parachoques trasero Jumpy I y II, P-309, Expert I y II (ver VAG)	162.341	6973.34
100	Remache fijac. tapizados interiores y protecciones AX (ver Ford, Mercedes, Opel, VAG)	162.373	
10	Remache fijac. tirante bandeja posterior C2, C3, DS3, Saxo, XM, Xsara Picasso, P-106, P-205, P-206, P-306, P-307, P-308 (ver VAG)	162.708	6992.18
50	Remache fijac. rejilla calandra P-306, P-406, fij. tapiz. maletero Jumpy I y II, Xsara II, P-307, P-308, Expert I y II, fijac. toma aire rejilla parabrisas P-206 (Eurocode 6539ASSHB) (ver Mercedes, VAG)	163.014	7813.24
25	Remache fijac. pasoruada, moldura inferior puerta y tapizados C2, C3 ->'10, C4 Picasso, C5 ->'07, C6, P-1007, P-308 '14->, P-407, fijac. rejilla calandra y soporte parachoques Jumpy, Expert I, II y III (ver Opel)	163.085	6991.X7
50	Remache fijac. pasoruada trasero, bajos carroceria y tapa motor C4, C5 '01->'07, P-307, P-607, fijac. parachoques y tapizados interiores C4 Picasso, C6, C8, P-3008, P-807, fijac. pasoruada C3 ('01->'04), P-207, P-406 restyling,	163.127	7013.J0 8211.WV
50	Remache fijac. superior parachoques delantero C1, P-107 (ver Lexus, Nissan, Toyota)	163.166	6822.N3
50	Remache fijac. spoiler trasero C1, P-107 (ver Lexus, Toyota)	163.167	6822.NK
50	Remache fijac. pasoruada, parachoques, tapa motor y bajos carroceria Berlingo '08->, C3 '10->, C3 Picasso, C4 '04->'10 y '11->, C5 '08->, C6, P-206, P-207, P-307, P-308, P-508, P-3008, P-5008, Partner '09->, fij. tapiz. interiores, porton trasero y tapa motor C4 Picasso, Jumpy III, Expert III, P-308 '14->, fijac. bajos carroceria C5 '05->'08, P-308 '14->, P-407 (ver Fiat)	163.344	8565.53 1609267280 1622749580
25	Remache fijac. guardabarros pasoruada y rejilla delantera P-108, C1 '14-> (ver Lexus, Toyota) fijac. parachoques trasero C1, P-107	163.358	7427.39 1608546180
25	Remache fijac. pasoruada C1, P-107, fij. junta rejilla aireación C1 '14->, P108 (ver Lexus, Toyota)	163.529	6822.N2
25	Remache fijac. parrilla radiador Boxer III '06->, Jumper III '06-> (ver Fiat)	163.963	7813.29
10	Remache fijac. deflector aire delantero C1, P-107 (ver Lexus, Toyota)	163.981	6822.N7

2617

Ø 4,2 x 17
arandela Ø 14



162.702

Ø 4,5 x 13



161.778

Ø 4,5 x 16



161.777

Ø 5 x 17
arandela Ø 15



161.762

Ø 5 x 22
arandela Ø 16



161.750

Ø 5 x 30
arandela Ø 16



161.856

Ø 6 x 26
arandela Ø 17



161.763

Ø 6 x 17,5



161.769

Ø 6 x 20



161.721

Ø M6 x 13



161.733

Ø M6 x 17,5



161.732

Ø M6 x 18



161.734

Ø M6 x 20



161.706

U.E.	DESCRIPCION	261	Ref. Adaptable
50	Tornillo Ø 6 x 20, fijac. parachoques - varios modelos - (ver Fiat)	161.706	7703 001 123
25	Tornillo Ø 6 x 20, varios usos (ver Opel, PSA)	161.721	
10	Tornillo Ø 6 x 17,5, fijac. cerraduras Kangoo II, 4x4	161.732	
10	Tornillo Ø 6 x 13, fijac. cerraduras Espace III, Express, Kangoo, Laguna, Master, Megane, Scenic	161.733	
10	Tornillo Ø 6 x 18, fijac. cerraduras Clio III, Modus	161.734	
25	Tornillo Ø 5 x 22 (aro Ø 16), fijac. pasoruada y parachoques Clio III y IV, Kadjar '15->, Kangoo II, Laguna III, Megane III y IV, Twingo II, fijac. emblema delantero Clio IV, fij. rejilla parabrisas Captur, Scenic III y IV, fij. moldura puerta, aleta trasera y rejilla Captur, Twingo III '14-> (ver Dacia, Opel)	161.750	7703 017 090
25	Tornillo Ø 5 x 17 (aro Ø 15), fijac. plásticas varias	161.762	7703 017 089
25	Tornillo Ø 6 x 26 (aro Ø 17), fijac. plásticas varias	161.763	
25	Tornillo Ø 6 x 17, fijac. pasoruada trasero Megane IV '16-> y otros usos	161.769	7703 017 104 7703 017 087
50	Tornillo Ø 4,5 x 16, fijac. varios usos	161.777	7703 017 138 7703 017 097
50	Tornillo Ø 4,5 x 13, fijac. varios usos	161.778	7703 017 011 7703 017 108
25	Tornillo Ø 5 x 30 (aro Ø 16), fijac. pasoruada Laguna III '07->	161.856	7703 017 145
25	Tornillo Ø 4,2 x 17 (aro Ø 14), fijac. pasoruada Laguna, Twingo (ver VAG)	162.702	7703 016 405

Ø M6 x 20
arandela Ø 18



161.727

Ø M6 x 20
arandela Ø 22



161.724

Ø M6 x 25



161.450

Ø M6 x 28
arandela Ø 24



161.731

Ø 6,3 x 15



161.432

Ø 6,3 x 16



162.478

Ø M7 x 15



161.728

Ø M8 x 22



162.619

Ø M8 x 20



161.705

Ø M8 x 26,5



161.729

U.E.	DESCRIPCION	261	Ref. Adaptable
25	Tornillo fijac. guardabarros - modelos antiguos -	161.432	0607 273 300
10	Tornillo (en jaula móvil) fijac. parachoques Clio	161.450	
10	Tornillo fijac. parachoques Twingo (ver Fiat)	161.705	
25	Tornillo Ø 6 x 20 (aro Ø 22), fijac. aletas y parachoques Captur, Clio IV '12->, Megane IV '16->, fijac. bajos carroceria Twingo III '14-> (ver Dacia)	161.724	7703 602 206
25	Tornillo Ø 6 x 20 (aro Ø 18), fijac. parachoques delantero Laguna III y varios usos (ver Dacia, Opel)	161.727	7703 602 282
10	Tornillo Ø 7 x 16, fijac. cerraduras - varios modelos -	161.728	7703 005 065
10	Tornillo Ø 8 x 26,5, fijac. cerraduras Espace III, Kangoo, Laguna, Master, Safrane	161.729	7703 026 053 7703 008 211
25	Tornillo Ø 6 x 28 (aro Ø 24) fijac. parachoques trasero -varios modelos-, fijac. rejilla calandra Clio IV, Laguna III, Latitude	161.731	7703 602 059
25	Tornillo Ø 6,3 x 16, fijac. guardabarros R-9/11, R-19, R-21, Clio, Super-5, Express, Megane, Laguna, Safrane, Twingo, Master, Traffic	162.478	7703 016 264
10	Tornillo fijac. parachoques R-5	162.619	7703 024 015

Ø 2,9



161.447

Ø 3,5



162.591

Ø 4,2



162.635

Ø 4,2



161.427

Ø 6,3



161.449

Ø 6,3



162.634

Ø 6,3



161.437

Ø 6,3



161.436

Ø 6,35

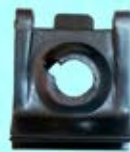

162.479

U.E.	DESCRIPCION	261	Ref. Adaptable
50	Clip fijac. protector guardabarros Clio I (ver BMW, Opel, VAG)	161.427	
50	Clip fijac. guardabarros Twingo, Megane, Safrane	161.436	
50	Clip fijac. varios usos R-9/11, Super-5, Express, Safrane, Master, Traffic	161.437	7703 046 012
50	Clip fijac. rejilla lateral R-5	161.447	
50	Clip fijac. guardabarros Twingo, Megane, Safrane	161.449	
50	Clip (Ø 6,35) fijac. guardabarros R-9/11, R-19, R-21, R-25, Clio, Super-5, Express, Laguna, Twingo, Master, Traffic	162.479	7703 046 049
50	Clip (Ø 3,9) fijac. varios usos	162.591	
50	Clip (Ø 6,3) fijac. varios usos	162.634	
50	Clip fijac. piloto delantero R-5	162.635	

2617

161.725

161.726

161.703

162.444

161.438

162.442

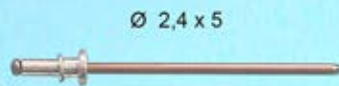
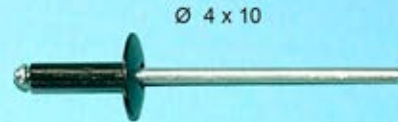
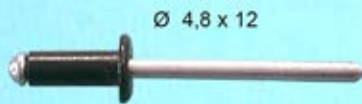
161.499

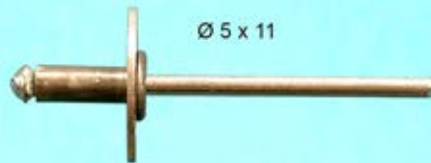
162.362

161.652

162.939

161.802

162.709

U.E.	DESCRIPCION	261	Ref. Adaptable
50	Clip (Ø 6) fijac. pasoruedas R-9/11, Clio, Super 5, Express, Laguna, Safrane, Espace, Master, Trafic (ver Ford)	161.438	7703 046 034
50	Clip fijac. talonera puerta Clio, Espace, Trafic (ver Ford, PSA)	161.499	7703 046 020
100	Remache 4 x 10, varios usos R-19, R-21, Espace, Traffic	161.652	
50	Clip fijac. varios usos Renault - varios modelos - (ver Ford, Mercedes)	161.703	7703 046 091
10	Fijac. varios usos Clio III, Megane CC, Modus, Scenic II	161.725	7703 044 167
10	Fijac. aletas Scenic II	161.726	
25	Fijac. parachoque Clio 3, Fluence, Laguna 3, Megane 2, 3 y 4, Modus, Scenic, Twingo 2	161.802	7703 072 337
50	Remache Ø 2,4 x 5, varias aplicaciones (ver Fiat, Ford, Opel, PSA, V.A.G.)	162.362	7703 001 123
50	Clip (Ø 6) fijac. pasoruedas R-9/11, Clio, Super-5, Express, Laguna, Safrane, Espace, Master, Trafic (ver Fiat, PSA, VAG)	162.442	7703 046 048
50	Clip fijac. protector - varios modelos - (ver Fiat)	162.444	
25	Remache fijac. (aro Ø 20) guardabarros Clio, Super-5, Express	162.709	7703 072 241
50	Remache 4,8 x 12 (cabeza de Ø 10) , varios usos R-21, R-25, Safrane	162.939	



U.E.	DESCRIPCION	261	Ref. Adaptable
10	Tuerca enjaulada especial Renault R-19 y otros modelos antiguos (Ø 6)	161.467	7703 044 037
50	Fijac. juntas estanqueidad puerta Megane, Scenic	161.478	
50	Fijac. parachoque delantero Captur, Trafic III '14->	161.807	2174 647 25R
25	Fijac. panel puerta Clio 4 '12->	161.828	7698 422 50R
50	Fijac. moldura portón trasero Clio 4 '12->	161.837	7703 080 117
25	Fijac. rejilla delantera Trafic III '14->	161.858	7698 473 02R
10	Tuerca bayoneta M-8 varios usos Renault	162.328	7703 044 121
25	Tuerca especial redonda varios usos (Ø 6) (ver Ford, PSA)	162.375	7703 044 058
50	Fijac. varios usos R-9/11, R-19, R-21, Super-5, Express, Clio, Laguna, Safrane, Espace, Twingo, Master, Trafic (ver Fiat, Ford, PSA)	162.465	7703 044 087
25	Fijac. tirante bajopuerta R-19, R-21, Super-5, Express, Clio, Master, Trafic	162.466	7701 397 164 7703 044 013 7703 044 172
25	Tuerca con aro móvil (Ø 6), varios usos Megane, Laguna (ver Dacia, Ford, Opel, PSA, VAG)	162.711	7703 033 156
25	Tuerca con aro móvil (Ø 8), varios usos Clio, Twingo (ver Ford, Opel, PSA, VAG)	162.712	7703 033 107
10	Fij. pasoruada y bajos carrocería Captur, Clio IV '12->, Fluence, Master III '10->, Megane IV '16->, Scenic I '96->'03, Trafic III (ver Dacia)	164.465	7703 041 045



175.224*



175.225*



163.019



163.126

* (imagen 1/2 tamaño real)



163.340 - Dcho.

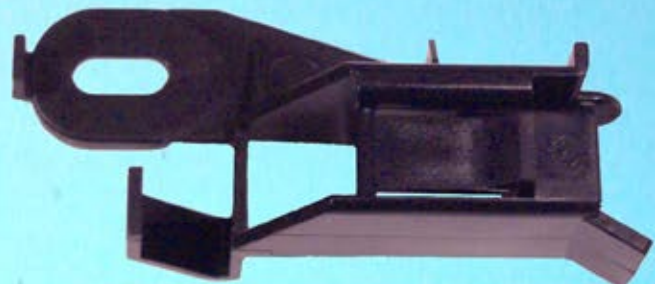

163.341 - Izdo.



163.342 - Dcho.



163.343 - Izdo.

U.E.	DESCRIPCION	261	Ref. Adaptable
10	Fijac. óptica Megane I (hasta ->9903)	163.019	7703 081 180
10	Fijac. soporte faro delantero Laguna II	163.126	7701 050 072
10	Fijac. derecha rejilla delantera a faro Megane I	163.340	7700 834 203
10	Fijac. izquierda rejilla delantera a faro Megane I	163.341	7700 834 202
10	Fijac. derecha rejilla delantera a faro Scenic I	163.342	7700 838 610
10	Fijac. izquierda rejilla delantera a faro Scenic I	163.343	7700 838 609
1	Regulador eléctrico faro Clio III, Espace IV, Kangoo '08, Laguna II y III '05->, Megane II '05->, Scenic III, Trafic II	175.224	8200 402 521
1	Regulador eléctrico faro Clio III, Espace IV, Laguna II '05->, Megane II '05->, Modus, Vel Satis (para faros Xenon)	175.225	8200 261 818

163.364

163.953

162.463

162.472

162.828

163.338

163.425

U.E.	DESCRIPCION	261	Ref. Adaptable
10	Fijac. vierteaguas techo Clio	162.463	7703 077 300
25	Fijac. vierteaguas Twingo, Megane, Scénic, Master, Traffic	162.472	7703 077 341
25	Fijac. moldura techo Clio '98	162.828	7703 077 438
10	Fijac. moldura techo Kangoo	163.338	7703 077 428 7700 351 266
10	Fijac. rejilla parabrisas Modus	163.364	8200 320 884
10	Base soporte parabrisas Master II (Eurocode 7247ASCV) (ver Fiat, Opel)	163.425	8200 333 033
10	Fijac. moldura techo Scenic II	163.953	7701 064 619

162.827

163.310

163.321

162.999

164.014

164.015

164.297

163.720

164.676

164.630

164.296

U.E.	DESCRIPCION	261	Ref. Adaptable
10	Fijac. parabrisas R-21	162.827	7705 099 009
10	Fijac. parabrisas Clio II ('98->), Clio III ('05->), Kangoo, Laguna II ('01->), Master III '10->, Megane I, Megane II, Scenic II (Eurocode 7248ASCH/7232ASCH)	162.999	7700 838 570
10	Base soporte parabrisas Clio I (incluye adhesivo) (Eurocode 7231ASFH/7232ASCH)	163.310	7700 789 274
10	Base soporte parabrisas R-19 (incluye adhesivo) (Eurocode 7236ASFH)	163.321	
10	Fijac. rejilla parabrisas "torpedo" Clio III '05->'12	163.720	7701 070 605
10	Base soporte derecho parabrisas Laguna I '94->'01 (Eurocode 7237ASCHBR)	164.014	7700 827 632
10	Base soporte izquierdo parabrisas Laguna I '94->'01 (Eurocode 7237ASCHBL)	164.015	7700 827 631
10	Fijac. rejilla parabrisas "torpedo" Twingo II '07->'14	164.296	7701 069 419
10	Fijac. soporte inferior parabrisas Master II '03->'10	164.297	7700 351 267
10	Fijac. rejilla parabrisas "torpedo" Captur (componente del kit Renault 7272 585 59R)	164.630	
10	Fijac. rejilla parabrisas "torpedo" Megane III '08->, Scenic III '08->, Trafic III '14->	164.676	7701 071 586 8201 495 920 7481 699 22R

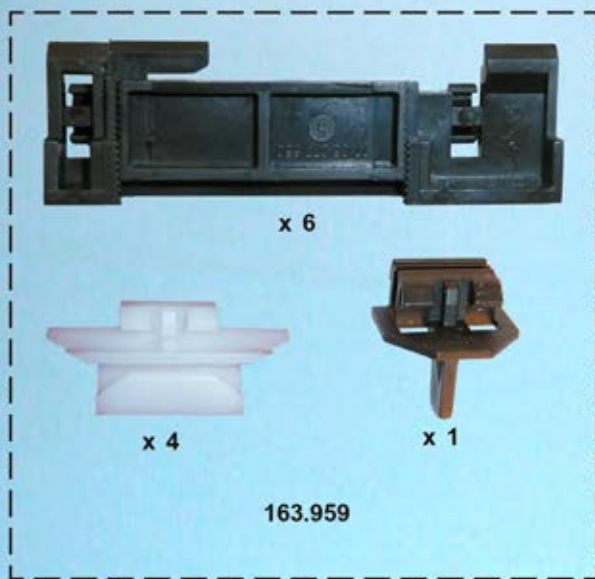

U.E.	DESCRIPCION	261	Ref. Adaptable
10	Fijac. moldura lateral parabrisas Clio III, Espace VI '15->, Scenic IV '16->, Symbol, Thalia (Eurocode 7262ASCBS)	163.673	7701 062 542 7701 070 377 8201 539 547
10	Fijac. moldura lateral parabrisas (parte inferior) Clio III (Eurocode 7262ASCBS1B)	163.674	8200 335 703
10	Fijac. moldura lateral parabrisas Vel Satis (Eurocode 7250ASCBS1B)	163.868	8200 294 204 8200 048 881
1	Kit fijac. moldura parabrisas Laguna '94->'01 (contiene 11 piezas) (Eurocode 7237AKCH)	163.959	7701 367 683
1	Kit fijac. moldura parabrisas Scenic III '10-> (contiene 7 piezas) (Eurocode 7280AKCMS2F)	163.978	76 8E 608 98R
10	Fijac. moldura lateral parabrisas Modus (Eurocode 7263ASCBS)	164.080	7701 060 537
10	Fijac. moldura superior parabrisas Trafic II '01->'14 (ver Nissan, Opel)	164.282	8200 004 389
10	Fijac. moldura lateral parabrisas Trafic III '14-> (Eurocode 6340ASCBS6B) (ver Fiat, Opel)	164.442	7276 051 74R



U.E.	DESCRIPCION	261	Ref. Adaptable
50	Fijac. rejilla parabrisas Vel Satis (ver PSA)	162.816	
25	Fijac. rejilla parabrisas Master III '10->, Trafic II '01->'14 (Eurocode 6300ASCVB) (ver Opel)	162.826	7703 077 430
25	Fijac. rejilla parabrisas "torpedo" Scenic IV '16->, fijac. moldura superior parabrisas y luneta trasera Megane III Coupé (ver Fiat, PSA)	163.083	7703 077 469 7703 077 468 8201 112 162
10	Fijac. moldura lateral parabrisas Scenic III '10-> (Eurocode 2735ASCMS) (ver PSA)	163.379	
50	Fijac. moldura parabrisas Captur, Clio IV '12-> (componente del kit Renault 7272 585 59R) (ver Dacia, Fiat, PSA)	163.453	8200 700 969
25	Fijac. moldura parabrisas Megane II Coupé / Cabrio (Eurocode 7261ASCC/AKCC1F) (componente del kit Renault 7701209200)	163.595	7701 057 073
10	Fijac. rejilla parabrisas "torpedo" Espace IV '02-> (Eurocode 7251ASCVB)	163.670	7701 056 146
25	Fijac. moldura techo-parabrisas Laguna III '07->	163.671	7701 053 507
10	Fijac. moldura parabrisas Megane II Coupé (Eurocode 7261ASCC6B) (componente del kit Renault 7701209200)	163.737	7701 061 133
25	Fijac. soporte rejilla parabrisas Megane III '09->, Fluence (Eurocode 7279ASCBSBK)	163.858	7701 070 813
10	Fijac. rejilla parabrisas "torpedo" Megane III Coupé, Trafic III '14-> (Eurocode 6340ASCVS) (ver Fiat, Opel, PSA)	163.882	7703 081 232
10	Fijac. moldura lateral parabrisas Megane III Coupé/Cabrio '10->	163.948	8201 111 623
25	Remache fijac. rejilla parabrisas "torpedo" Clio IV '12->, Espace V '15->, Kadjar '15->, Master '10->, Megane III y IV '08->, Scenic III y IV '08->, Trafic III '14-> (ver Dacia, Nissan)	164.254	0540 000 01R
10	Fijac. cala parabrisas y luneta trasera Captur, Clio IV '12, Megane III, Scenic I, II y III, Trafic III '14, Twingo II y III '07 y '14-> (ver Dacia)	164.391	9035 627 59R 8200 048 913
10	Fijac. tope cala parabrisas Clio III '05->'12	164.393	8200 410 679
25	Taco fijac. rejilla parabrisas "torpedo" Captur (componente del kit Renault 7272 585 59R)	164.629	7703 081 214

261/



163.584* - Dcho.
163.585* - Izdo.



164.598
Dcho. / Izdo.



163.574 - Dcho.
163.575 - Izdo.



163.578 - Dcho.
163.579 - Izdo.



163.580* - Dcho.
163.581* - Izdo.



163.666* - Dcho.
163.667* - Izdo.



163.576* - Dcho.
163.577* - Izdo.

* (imagen 1/2 tamaño real)

U.E.	DESCRIPCION	261	Ref. Adaptable
1	Soporte cristal elevalunas delantero derecho Megane I '96->'02	163.574	
1	Soporte cristal elevalunas delantero izquierdo Megane I '96->'02	163.575	
1	Soporte cristal elevalunas trasero derecho Megane I '96->'02	163.576	
1	Soporte cristal elevalunas trasero izquierdo Megane I '96->'02	163.577	
1	Soporte cristal elevalunas delantero derecho Scenic I '97->'03	163.578	
1	Soporte cristal elevalunas delantero izquierdo Scenic I '97->'03	163.579	
1	Soporte cristal elevalunas trasero derecho Scenic I '97->'03	163.580	
1	Soporte cristal elevalunas trasero izquierdo Scenic I '97->'03	163.581	
1	Soporte cristal elevalunas trasero derecho Megane II '02->'08	163.584	
1	Soporte cristal elevalunas trasero izquierdo Megane II '02->'08	163.585	
1	Soporte cristal elevalunas trasero derecho Clio II '98->'05, Symbol (ver Dacia)	163.666	
1	Soporte cristal elevalunas trasero izquierdo Clio II '98->'05, Symbol (ver Dacia)	163.667	
1	Kit soporte cristal elevalunas delantero Laguna II '01->'07	164.598	



164.003*
Dcho. / Izdo.



164.367*
Dcho. / Izdo.



164.364*- Dcho.



164.368*
Dcho. / Izdo.



164.365*- Izdo.



164.470*
Dcho. / Izdo.



164.008*- Dcho.
164.009*- Izdo.



164.002
Dcho. / Izdo.



164.474
Dcho. / Izdo.

* (imagen 1/2 tamaño real)

U.E.	DESCRIPCION	261	Ref. Adaptable
1	Soporte cristal elevalunas delantero Clio II '98->'05	164.002	
1	Kit soporte cristal elevalunas delantero Clio III '05->'12	164.003	
1	Soporte cristal elevalunas delantero derecho Master '98->'10 (ver Fiat, Opel, PSA)	164.008	
1	Soporte cristal elevalunas delantero izquierdo Master '98->'10 (ver Fiat, Opel, PSA)	164.009	
1	Kit soporte cristal elevalunas derecho Kangoo '08->	164.364	
1	Kit soporte cristal elevalunas izquierdo Kangoo '08->	164.365	
1	Kit soporte cristal elevalunas delantero Megane II '02->'08 (ver PSA)	164.367	
1	Kit soporte cristal elevalunas delantero Modus, Scenic II (ver PSA)	164.368	
1	Kit soporte cristal elevalunas delantero Clio IV '12->	164.470	
10	Clip elevalunas derecho e izquierdo Megane III, Fluence '08->	164.474	

261/



162.727



162.728



162.306

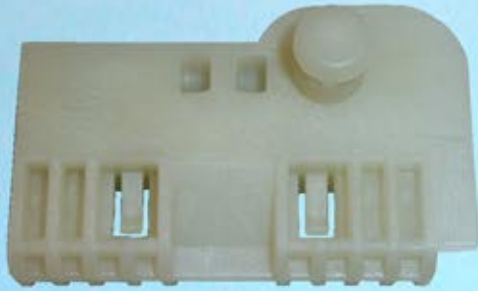

164.398* - Dcho.
164.399* - Izdo.



164.471
Dcho. / Izdo.

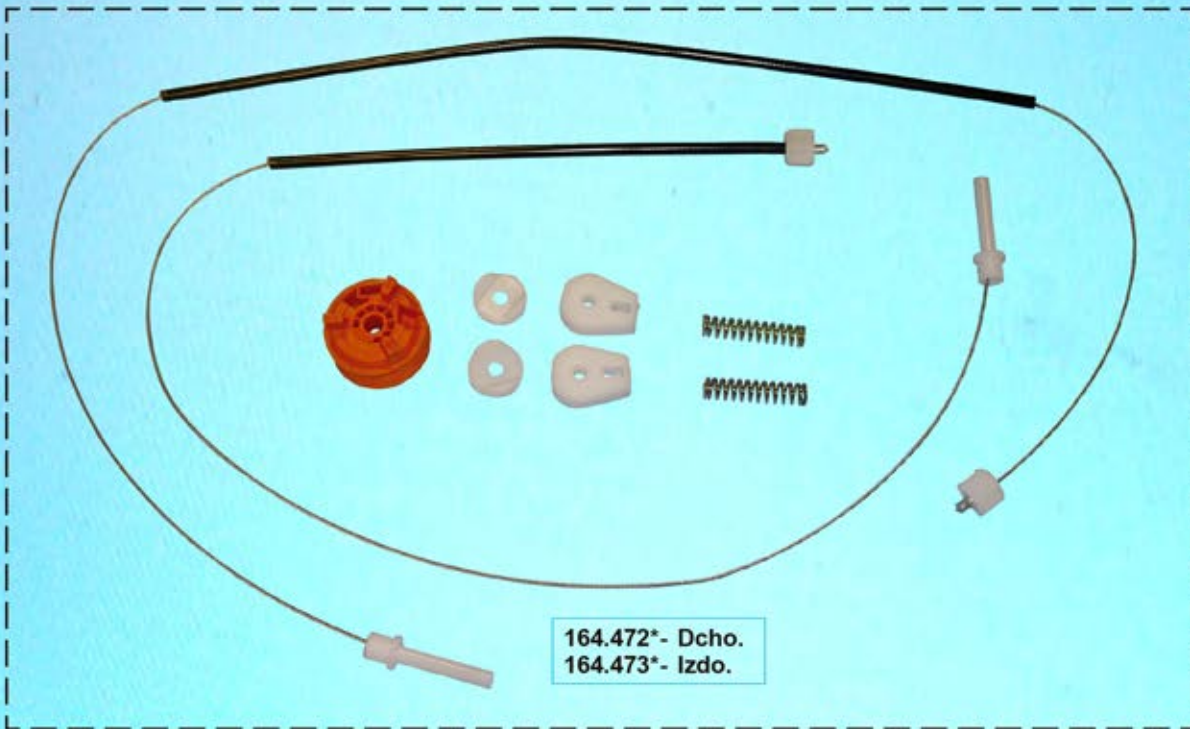

164.472* - Dcho.
164.473* - Izdo.

* (imagen 1/2 tamaño real)

U.E.	DESCRIPCION	261	Ref. Adaptable
10	Fijac. cristal lateral R-19, Clio, Megane (Eurocode 7231LSCHFDS)	162.306	7700 838 242
25	Fijac. mecanismo alzacristales R-19, Clio, Espace IV, Megane, Laguna II, Vel Satis (Eurocode 7239LSCHFD)	162.727	7700 784 690
25	Fijac. mecanismo alzacristales Clio, Laguna, Safrane, Espace	162.728	7700 757 267
1	Soporte cristal elevalunas trasero derecho Clio III '05->'12	164.398	
1	Soporte cristal elevalunas trasero izquierdo Clio III '05->'12	164.399	
1	Kit soporte cristal elevalunas trasero Megane II Cabrio '03->'09 (ver PSA)	164.471	
1	Kit reparación cristal elevalunas trasero derecho Megane II Cabrio '03->'09	164.472	
1	Kit reparación cristal elevalunas trasero izquierdo Megane II Cabrio '03->'09	164.473	



162.829



163.324



163.363



163.320



164.303



162.694



163.202



163.203



163.383



163.668 *- Dcho/Izdo.



164.350 *- Dcho/Izdo.

* (imagen 1/2 tamaño real)

U.E.	DESCRIPCION	261	Ref. Adaptable
10	Fijac. parachoques posterior Twingo	162.694	7700 817 502
10	Fijac. rejilla a parachoques Clio '98	162.829	7700 416 965
10	Soporte parachoques delantero Laguna II y III (lado derecho)	163.202	8200 138 448
10	Soporte parachoques delantero Laguna II y III (lado izquierdo)	163.203	8200 138 447
50	Fijac. insonorizantes y pasoruada Clio III, Laguna II y III, Latitude, Megane III, Modus, Scenic II y III, Twingo II, Vel Satis (ver Dacia)	163.320	7703 081 056
25	Fijac. frontales y pasoruada Megane II	163.324	- sin despiece -
25	Fijac. rejilla a calandra Kangoo II, fijac. pasoruada Espace IV, Master III '10->	163.363	7703 081 155
10	Fijac. aletas delanteras Clio II, Espace IV, Laguna II, Scenic	163.383	7700 412 158
1	Kit (2 piezas) soporte parachoques delantero Kangoo II '03->, Espace IV '02->, Laguna III '07->	163.668	8200 012 580
50	Fijac. pasoruada Twingo III '14->, fijac. insonorizante capó Captur (ver Dacia)	164.303	7703 081 237
1	Kit (2 piezas) soporte parachoques delantero Megane III '08->	164.350	6205 000 01R

2617



164.381



162.721



164.386



164.521



163.665



162.722



163.224



164.520



163.885



163.366

U.E.	DESCRIPCION	261	Ref. Adaptable
-	Tope (goma) capó Clio	162.721	7700 818 973
10	Fijac. varilla capó Clio, Express	162.722	7703 077 199
10	Fijac. varilla capó Clio III, Laguna II, Megane II, Modus, Scenic II	163.224	7703 179 010
10	Fijac. varilla capó Clio III	163.366	7705 002 130
5	Soporte tapa superior motor Renault Kangoo	163.665	7701 056 972
10	Fijac. varilla capó Laguna (ver PSA)	163.885	7703 079 812
10	Tope (goma) capó y portón Clio, Twingo, Master, Traffic (ver Fiat, PSA)	164.381	
5	Tope (goma) capó Megane II '02->'08	164.386	7700 843 546
5	Tope portón trasero Megane III '08->	164.520	8200 401 454
5	Tope (goma) capó Captur, Clio IV '12, Espace IV, Kadjar, Megane III '08, Symbol '08, Trafic III '14 (ver Dacia)	164.521	8200 048 938

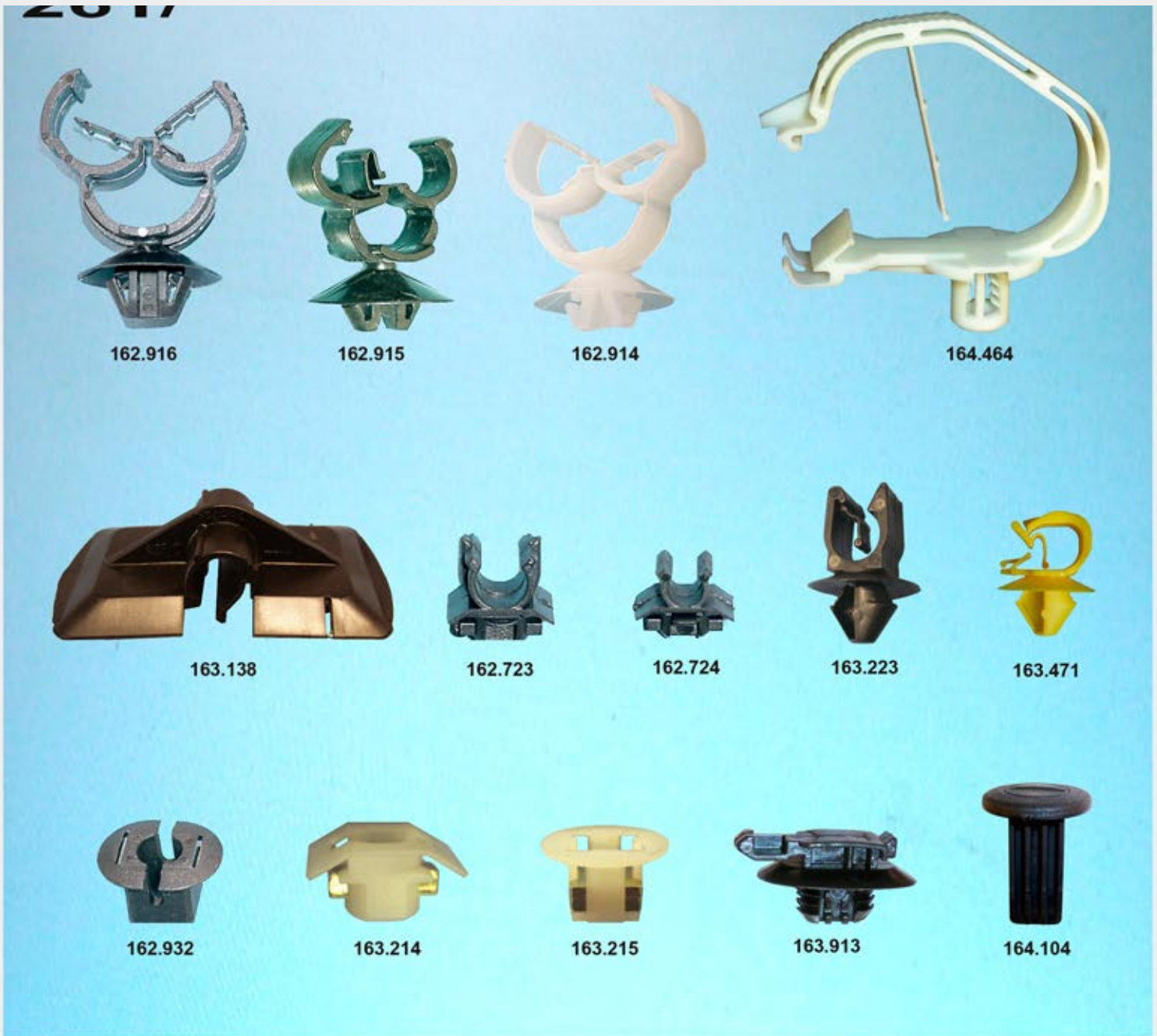

U.E.	DESCRIPCION	261	Ref. Adaptable
10	Fijac. varilla capó Super-5, Express, Megane, Laguna, Master, Traffic	162.723	7703 079 328
10	Fijac. varilla capó Twingo	162.724	7703 079 714
10	Fijac. cableado (Ø 6-12) puerta Clio	162.914	7703 079 562
10	Fijac. cableado (Ø 6-12) puerta Clio, Express, Megane	162.915	7703 079 351
10	Fijac. cableado (Ø 6-12) capó R-19, R-21, Twingo, Laguna, Traffic	162.916	7703 079 369
25	Fijac. rejilla delantera R-19, R-21	162.932	7703 081 103
10	Fijac. varilla capó Clio II	163.138	7703 077 439
25	Fijac. (con inserto tornillo Ø6) rejilla radiador y otros usos R-21, R-25, Super-5, Express, Master, Traffic, Kangoo (ver PSA)	163.214	7703 044 097
25	Fijac. (con inserto tornillo Ø6) rejilla radiador y otros usos R-21, R-25, Super-5, Express, Master, Megane, Laguna	163.215	7703 044 101
10	Fijac. varilla capó Clio III, Laguna II, Megane II, Scenic II	163.223	7703 079 870
10	Fijac. varilla capó Laguna III	163.471	7703 179 088
25	Fijac. cableria -varos modelos- (ver PSA)	163.913	8200 222 830
10	Fijac. rejilla calandra Vel Satis, y otros usos Espace IV, Laguna III	164.104	7701 056 776
10	Fijac. insonorizante interior Captur y otros modelos	164.464	7703 179 027



162.426



162.860



162.861



162.862



162.863



162.864



162.865



162.866



162.867



162.868



163.318

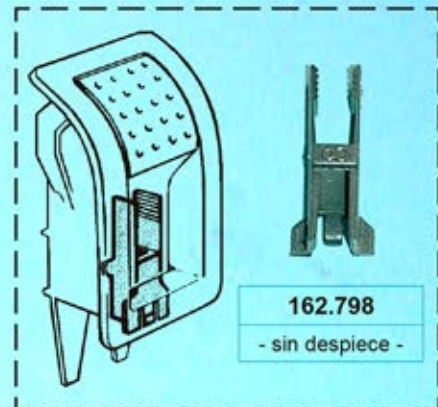

162.798

- sin despiece -

U.E.	DESCRIPCION	261	Ref. Adaptable
25	Fijac. varilla cerradura puerta R-11, R-19, Clio, Super-5, Express, Megane, Laguna, Safrane, Espace	162.426	7701 030 059
10	Fijac. seguro puerta Laguna, Safrane (ver P.S.A.)	162.798	- sin despiece -
25	Fijac. varilla cerradura puerta Twingo	162.860	7701 408 876
25	Fijac. varilla cerradura puerta R-19, Clio, Super-5, Express, Laguna, Safrane, Twingo, Espace, Master, Traffic	162.861	7701 030 058
25	Fijac. varilla cerradura puerta R-19, Clio, Super-5, Express, Megane, Laguna, Safrane, Twingo, Espace	162.862	7701 030 060
25	Fijac. varilla cerradura puerta Clio, Megane, Laguna, Safrane	162.863	7701 035 664
25	Fijac. varilla cerradura puerta Clio	162.864	7701 408 875
25	Fijac. varilla cerradura puerta Clio	162.865	7701 408 877 7703 079 714
25	Fijac. varilla cerradura puerta Megane	162.866	
10	Fijac. varilla cerradura puerta Clio, Safrane	162.867	7700 801 556
10	Fijac. varilla cerradura puerta Clio, Safrane	162.868	7700 801 557
50	Fijac. varilla cerradura puerta Kangoo (ver PSA)	163.318	



163.081



163.135



163.143



163.182



163.225



163.325



164.106



162.475



162.881



163.451

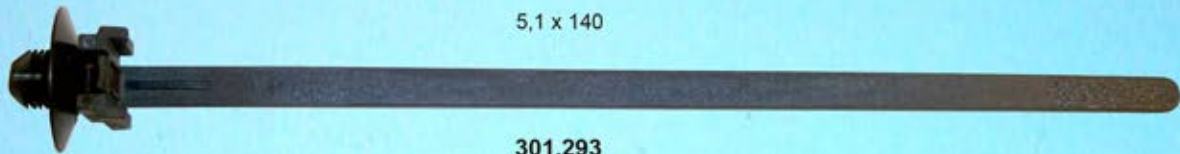

5,1 x 140

301.293

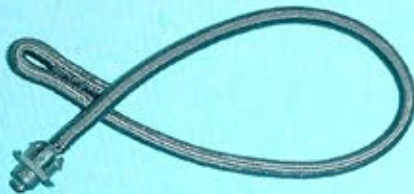

182.310*



182.314*

* (imagenes NO a tamaño real)

U.E.	DESCRIPCION	261	Ref. Adaptable
25	Fijac. junta estanqueidad puerta Clio I (ver Fiat)	162.475	7701 408 860
50	Fijac. goma capó Laguna, Safrane, y junta puerta delantera Safrane	162.881	
50	Fijac. gomas puerta y capó Kangoo, Laguna, Master (ver P.S.A.)	163.081	
50	Fijac. juntas estanqueidad Laguna, Kangoo, Master (ver Ford, PSA)	163.135	7701 044 547
25	Fijac. junta capó Espace IV, Vel Satis	163.143	
50	Fijac. junta goma puerta Clio IV, Megane II	163.182	8200 176 228
50	Fijac. junta goma puerta Captur, Megane II y III (ver Volvo)	163.225	8201 033 717
50	Fijac. gomas puerta y capó Clio III, Trafic II	163.325	
50	Fijac. (Ø 6,2) gomas puerta Clio III	163.451	
50	Fijac. junta goma puerta Clio III	164.106	8200 693 829
-	Tirante bandeja posterior Clio (long.total 240 mm.)	182.310	
-	Tirante bandeja posterior R-19, Megane (long.total 260 mm.)	182.314	
50	Abrazadera (5,1 x 140) con soporte para fijac. cable eléctrico Laguna III, Megane III, Scenic III (ver PSA)	301.293	8200 192 003



162.962

162.995

163.444

163.445

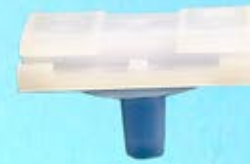
162.997

162.681

162.682

163.718

163.719

U.E.	DESCRIPCION	261	Ref. Adaptable
10	Fijac. molduras laterales Megane, Scénic (color blanco/rojo)	162.681	7701 043 799
10	Fijac. molduras laterales Megane, Scénic (color blanco/azul)	162.682	7701 040 837
50	Fijac. molduras puertas Clio II, Kangoo, Megane, Megane II Coupé, Scenic III, Vel Satis	162.962	7701 047 661
25	Fijac. molduras laterales Kangoo	162.995	7703 077 448
10	Fijac. molduras Espace IV	162.997	
25	Fijac.(Ø 8,2) bandas portón y maletero Clio II	163.444	
25	Fijac.(Ø 12,2) bandas portón y maletero Clio II, Megane Break	163.445	
10	Fijac. molduras laterales puerta Megane II	163.718	8200 666 724 8200 369 224
10	Fijac. molduras laterales puerta Scenic II	163.719	8200 699 857 8200 369 854

162.992

162.993

162.994

162.824

163.144

163.504

163.727

163.083

162.967

163.714

162.996

161.423

163.446

164.096

U.E.	DESCRIPCION	261	Ref. Adaptable
100	Fijac. molduras R-19, Clio I, Laguna, Safrane	161.423	7703 077 256
50	Fijac. molduras R-19, Clio II, Kangoo, Laguna, Megane, Scénic, Trafic II (ver Opel) (componente del kit Renault Trafic II OEM: 7701 470 769)	162.824	7703 077 309
50	Fijac. molduras laterales Fluence, Megane III, Twingo II (ver PSA)	162.967	7701 049 270
50	Fijac. molduras Kangoo, Master (ver Fiat, Opel)	162.992	7703 077 420
50	Fijac. molduras Kangoo, Master, Trafic II, fijac. panel portón trasero Kangoo (ver Fiat, Opel) (componente del kit Renault Trafic II OEM: 7701 470 769)	162.993	7703 077 422
25	Fijac. molduras Kangoo, Master, Trafic II (componente del kit Renault Trafic II OEM: 7701 470 769) (ver Opel)	162.994	7703 077 421
25	Fijac. molduras Clio II, Kangoo II, Laguna II, Megane, Scénic RX4	162.996	
25	Fijac. moldura lateral Espace IV, Kangoo II, Master '10->, Megane III, Scenic IV, Trafic III, Zoé, fijac. moldura pasoruera Kadjar '15->, fijac. rejilla delantera a faro Kangoo, fijac. moldura portón trasero Symbol / Thalia, fijac. otros usos Modus, Vel Satis (ver Fiat, PSA)	163.083	7703 077 469 7703 077 468 8201 112 162
25	Fijac. bandas laterales Scenic RX4	163.144	7701 050 730 7701 048 296
25	Fijac. molduras laterales Clio III, Megane III Coupé, Twingo II	163.446	7701 061 797
10	Fijac. moldura aleta delantera Clio III y IV, Twingo II y III	163.504	8200 389 607
25	Fijac. molduras puertas y techo Espace IV	163.714	7701 056 059
50	Fijac. molduras talonera puerta Clio 4 '12-> (ver Dacia, Mini, PSA)	163.727	8200 904 084
25	Fijac. molduras laterales puerta Clio 4 '12->	164.096	2174 663 71R

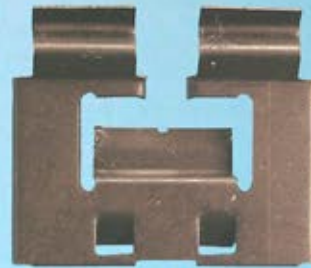
162.462

162.327

162.473

162.474

162.488

162.489

162.687

162.683

162.684

162.685

162.686

U.E.	DESCRIPCION	261	Ref. Adaptable
10	Fijac. molduras Express (metálica)	162.327	7703 080 048
5	Fijac. molduras laterales R-21	162.462	
25	Fijac. molduras laterales Clío (1ª serie) (color blanco)	162.473	7701 408 846
25	Fijac. molduras laterales Clío (1ª serie) (color rojo)	162.474	7701 408 847
25	Fijac. molduras laterales Clío (2ª serie) (color blanco)	162.488	7703 077 362
25	Fijac. molduras laterales Clío (2ª serie) (color rojo)	162.489	7703 077 363
10	Fijac. molduras laterales Laguna (color verde)	162.683	
10	Fijac. molduras laterales Laguna (color blanco)	162.684	
10	Fijac. molduras laterales Laguna (color rojo)	162.685	
10	Fijac. molduras laterales Laguna (color gris)	162.686	
10	Fijac. molduras laterales Laguna (color blanco)	162.687	



U.E.	DESCRIPCION	261	Ref. Adaptable
25	Fijac. apoyabrazos y manecilla puerta R-5, R-9/11, R-18, R-19, Super-5, Express	161.424	7703 081 013
25	Fijac. revestimientos interiores R-9/11, R-5, Super-5, Express	162.451	7703 077 109
25	Fijac. revestimientos interiores R-9/11, R-21, Super-5, Express	162.452	7703 077 108
50	Boca (Ø 10) para revestimientos montante Megane (ver PSA)	162.648	7700 836 190
10	Fijac. (con boca premontada) revestimientos interiores Super-5	162.672	7703 077 243
25	Fijac. revestimientos interiores Super-5, Express	162.673	7703 077 192
50	Boca fijac. panel puerta y tapizados R-21, Super-5, Express, Laguna (ver PSA)	162.675	7701 397 195
10	Tapón agujeros puerta Clio, Megane, Laguna, Master II, Traffic	162.912	7703 074 112
25	Fijac. paneles portón posterior y montantes cinturón seguridad Kangoo, fijac. tapizados interiores Clio II, Traffic II	163.043	7703 077 434
50	Fijac. tapizados portón trasero Espace III	163.092	
25	Fijac. tapizados interiores Master II (ver VAG)	163.115	7703 077 449
10	Fijac. soporte aleta delantera Captur, Espace V '15->, fijac. tapizados interiores Modus	163.381	8200 302 291
25	Fijac. tapizados interiores Master	163.382	7703 077 457
25	Fijac. tapizados interiores -varios modelos- (ver Chevrolet, Opel, PSA)	163.876	7703 077 477



163.139



163.142



163.145



163.378



163.379



161.422



162.961



162.826



163.141



162.816



163.858



164.610



164.806

U.E.	DESCRIPCION	261	Ref. Adaptable
50	Fijac. panel puerta y revestimientos interiores R-19, Clio I y II, Megane I y II, Kangoo, Laguna I y II, Modus, Safrane, Twingo, Master, Trafic	161.422	7703 077 250
50	Fijac. tapizados interiores -varios modelos -	162.816	
25	Fijac. panel puerta Clio II, Kangoo, Megane, Scénic, fijac. rejilla parabrisas Master '10->, Trafic II (ver Opel)	162.826	7703 077 430
50	Fijac. panel puerta Megane, Clio'98, Kangoo, fijac. otros usos Laguna I, Megane II, Trafic I	162.961	7703 077 354
10	Fijac. tapizados portón trasero Scenic I	163.139	7703 077 441
25	Fijac. panel puerta y tapizados interiores Espace IV, Laguna II, Trafic II (ver Land Rover, Opel)	163.141	7701 050 734 5001 855 049 7703 077 368
25	Fijac. moldura rejilla parabrisas Twingo II '07->, fijac. molduras laterales Scenic RX4, fijac. tapizados interiores Laguna II, Megane CC, Modus, Scenic RX4, Vel Satis,	163.142	7701 049 008 7701 057 132
10	Fijac. tapizados portón trasero Laguna II, Espace IV	163.145	7701 058 820
10	Fijac. panel puerta Laguna II (ver PSA)	163.378	
10	Fijac. moldura lateral parabrisas Scenic III (Eurocode 2735ASCMS) (componente del kit OEM: 768E60898R) (ver PSA)	163.379	
25	Fijac. tapizados interiores - varios modelos -	163.858	7701 070 813
5	Fijac. tapizados interiores pilar A Captur	164.610	7698 471 47R
10	Fijac. panel puerta Megane IV '15->	164.806	7481 640 22R

163.891

163.453

163.082

163.083

163.669

164.731

162.229

162.372

163.595

162.669

162.234

162.998

U.E.	DESCRIPCION	261	Ref. Adaptable
100	Fijac. panel puerta y revestimientos interiores R-5, R-12, R-18 (ver Fiat, PSA)	162.229	7703 077 059
50	Fijac. panel puerta y vano rueda Super-5, Express	162.234	7703 077 193
100	Fijac. panel puerta y revestimientos interiores R-5, R-9/11, Super-5, Express, Master, Traffic (ver Ford, PSA)	162.372	7703 077 111
25	Fijac. panel puerta y revestimientos interiores Kangoo, Laguna, Safrane	162.669	7703 077 345
25	Fijac. guarnecidos interiores Clio II, Megane I	162.998	
50	Fijac. panel puerta Clio III, Kangoo, Scenic II y RX4, Vel Satis, fijac. parachoques trasero Megane II, fijac. panel puerta y embellecedor exterior Espace IV (ver Dacia, PSA, VAG, Volvo)	163.082	7701 056 846
25	Fij. panel puerta y rejilla delantera Megane II, Scenic II, Twingo II, fijac. tapiz. interiores Clio II, Scenic II, Megane III (ver Fiat, PSA)	163.083	7703 077 469 7703 077 468 8201 112 162
50	Fijac. panel puerta Wind (ver Dacia, Fiat, PSA)	163.453	8200 700 969
25	Fijac. tapizados interiores Megane II 2 puertas y Megane CC, fij. moldura parabrisas Megane II CC (Eurocode 7261ASCC/AKCC1F)	163.595	7701 057 073
25	Fijac. panel puerta Espace V '15->, Fluence, Kadjar, Laguna III '07->, Latitude, Master III '10->, Megane III, Scenic III, fijac. tapizados maletero Kadjar '15-> (Eurocode 7280SSSCMFD) (ver Opel, PSA)	163.669	7703 077 476
25	Fijac. tapizados puerta Trafic II	163.891	8200 186 255
25	Fijac. panel puerta Espace IV '02->'15	164.731	7701 057 716



162.705



162.450



163.447



163.385



162.875



163.327



162.975



162.823



162.643



163.879



163.006



163.007

U.E.	DESCRIPCION	261	Ref. Adaptable
50	Fijac. aislante vano motor R-19, R-21, R-25, Clio, Super-5, Kangoo, Express, Megane, Modus, Laguna, Safrane, Master, Traffic	162.450	
100	Fijac. tapizados interiores - varios modelos -	162.643	7703 077 079
25	Fijac. spoiler a parachoques delantero Clio	162.705	7703 077 080
100	Fijac. tapizados interiores - varios modelos - (ver Seat)	162.823	7703 077 223
25	Fijac. protector pasoruada Megane, Scénic, Laguna	162.875	7703 081 188
25	Fijac. aislante capó Renault - varios -, fij. alfombra Clio II y III	162.975	7703 077 444
50	Fijac. pasoruada Laguna II y III, Latitude, fijac. tapiz. alfombras piso Clio IV, Latitude, Megane III, Scenic III, fijac. insonoriz. capó Clio III, Megane II y III, Scenic II y III, Master III (ver Dacia)	163.006	7703 077 117
50	Fijac. insonorizante capó Laguna II, fijac. tapizados maletero Captur	163.007	6001 546 909 7703 077 090
25	Fijac. insonorizante capó Laguna II y III, Master, Vel Satis	163.327	7703 077 453
25	Fijac. tapizados interiores Traffic (ver Nissan, Opel)	163.385	7703 077 471
50	Fijac. tapizados interiores Kangoo	163.447	
50	Fijac. tapizados interiores Master III '10->	163.879	8200 939 873

2617



U.E.	DESCRIPCION	261	Ref. Adaptable
100	Fijac. panel y tapicería todos los modelos (Negro) (ver Opel, PSA)	162.221	
100	Fijac. panel y tapicería todos los modelos (Gris) (ver Opel, PSA)	162.222	
100	Fijac. revestimientos interiores R-9, R-11, R-19, R-21, R-25, Super-5, Express, Clio, Megane, Twingo, Laguna, Safrane, Espace (ver Mercedes, PSA)	162.453	7703 077 068
100	Fijac. revestimientos interiores R-9/11, R-5, R-18, R-19, Super-5, Express, Espace, Safrane (ver PSA)	162.454	7703 077 066 7703 077 148
100	Fijac. tapizados interiores - varios modelos -	162.646	
50	Fijac. pasoruada R-19, R-25, Clio, Super-5, Express, Kangoo, Megane, Twingo, Laguna, Safrane, Master, Traffic (ver PSA)	162.656	7703 077 225
100	Fijac. tapizados interiores - varios modelos - (ver Mercedes, Nissan, PSA)	162.934	7703 077 153 7703 077 356
25	Fijac. revestimientos interiores R-19, R-21, R-25, Super-5, Express, Twingo, Clio I y III, Laguna I y II, Safrane, Master, Traffic (ver Dacia, Ford, PSA)	162.941	7703 081 054
50	Fijac. pasoruada Captur, Clio II, III y IV, Espace IV, Kangoo I y II, Laguna I, II y III, Latitude, Megane I, II y III, Master II y III, Modus, Scenic I, II y III, Twingo I, II y III, fijac. alfombras Laguna II y III, Megane II, III y IV, Scenic II y III (ver Dacia)	163.008	7703 077 435
25	Fijac. insonorizante y tapizados interiores Clio III, Espace V '15->, Fluence, Latitude, Master III '10, Megane II y III, Scenic II y III, Twingo II '07->, fijac. vierteaguas lateral Fluence, Megane III '08->, fijac. rejilla calandra Twingo II '07-> (ver Dacia)	163.906	7703 081 227
25	Fijac. insonorizante Captur, fijac. tapizados Wind y otros usos otros modelos (ver Dacia)	164.468	7703 081 127
25	Fijac. insonorizante motor Scenic I '07->'03, Trafic II '01->'14	164.810	7703 077 458



162.595



162.700



162.701



162.471



163.042



163.146



163.362



163.452



164.105



164.103



164.301



164.102



163.428



163.429

U.E.	DESCRIPCION	261	Ref. Adaptable
25	Fijac. anagrama capó Clio, Espace, Express, Master, Safrane, Super-5, Traffic, Twingo	162.471	7703 081 161
25	Fijac. letreros R-5	162.595	7703 081 003
25	Fijac. anagrama capó Clio, Espace, Laguna, Master, Megane, Safrane, Traffic, Twingo	162.700	7703 081 170 7703 081 190
25	Fijac. anagrama portón y siglas modelo Clio, Express, Laguna, Master, Megane, Safrane, Super-5, Traffic, Twingo	162.701	7703 081 151
25	Fijac. monograma Clio II, Scenic II	163.042	
10	Fijac. anagramas Espace IV, Laguna II, Megane II	163.146	8200 305 109
50	Fijac. anagramas Captur, Clio III, Espace IV, Kangoo II, Laguna I / II y III, Megane II, Megane III, Modus, Scenic II, Twingo II, fijac. moldura pilar C Twingo III '14->	163.362	7703 081 224
25	Fijac.varios usos Scenic II, Twingo II (ver V.A.G.)	163.428	
25	Fijac.varios usos Clio III	163.429	7703 081 222
10	Fijac. anagramas Clio III y IV, Espace IV, Megane II, Twingo II, fijac. embellecedor superior aleta Clio III y IV, Megane III	163.452	7703 081 212
25	Fijac. varios usos Megane III Coupé, Scenic III (ver PSA)	164.102	7711 429 840
10	Fijac. airbag Latitude, Scenic III, fijac. pantallas térmicas escape Kangoo '08->	164.103	7703 072 393
10	Fijac. varios usos Laguna III	164.105	7711 429 846
50	Fijac. panel puerta Captur (ver Dacia)	164.301	7703 081 223

7 x 13
Tornillo Ø 4,2



162.523

7 x 14



163.881

7 x 14
Tornillo Ø 3,9



163.502

7 x 14
Tornillo Ø 3,9



163.222

7 x 14
Tornillo Ø 4,2



162.483

7 x 15
Tornillo Ø 3,9



163.882

8 x 11,6
Tornillo Ø 5,5



164.101

10 x 19,3
Tornillo Ø 4,2



164.629

12 x 15



164.361

7 x 7
Tornillo Ø 3



162.238

7 x 7
Tornillo Ø 3,5



162.717

7,2 x 7,2
Tornillo Ø 3,5



163.426

8 x 8
Tornillo Ø 4



162.903

8 x 8
Tornillo Ø 4,2



163.427

8 x 8



163.883

8 x 8
Tornillo Ø 4,8



162.468

8,5 x 8,5
Tornillo Ø 4



162.649

U.E.	DESCRIPCION	261	Ref. Adaptable
100	Taco fijac. revestimientos interiores R-9/11, R-19, R-21, R-25, Clio, Safrane, Espace, Master, Trafic, fijac. vano rueda Twingo, fijac. molduras Express (ver Fiat, Ford, Mercedes, Seat)	162.238	7703 081 086
25	Taco fijac. revestimiento puerta Megane, fijac. apoyabrazos Clio	162.468	7703 081 147
25	Taco fijac. guía puerta y tapicería Twingo, Master, Traffic	162.483	7703 081 134
50	Taco fijac. varios usos R-9/11, Clio, Super-5, Express, Megane, Laguna, Safrane, Twingo, Espace, Master, Traffic (ver Fiat, PSA)	162.523	7703 081 019
100	Taco fijac. varios usos Renault	162.649	
25	Taco fijac. revestimiento portón Laguna	162.717	
25	Taco fijación parachoques Kangoo II, Megane, Scénic, Twingo II, fijac. panel puerta Megane III y otros usos varios modelos (ver Opel)	162.903	7703 081 184
25	Taco fijac. revestimientos interiores varios modelos (ver Dacia, Fiat, Opel, PSA)	163.222	7703 081 185
50	Taco fijac. embellecedor exterior puerta Laguna III, Latitude, Megane III, Fluence, fijac. armazón delantero Twingo	163.426	7703 081 160
50	Taco fijac. armazón delantero Twingo	163.427	7703 081 163
50	Taco fijac. tapizados interiores Megane II, fijac. talonera Kangoo II, fijac. moldura puerta Laguna III (ver PSA)	163.502	7703 081 164
50	Taco fijac. moldura parabrisas Scenic III, fijac. pilar B Megane IV '16->, Scenic IV '16->, fijac. tapizados maletero Captur, Kadjar '15-> (ver Dacia, PSA)	163.881	7700 081 233
10	Taco fijac. rejilla parabrisas "torpedo" Megane III Coupé, Trafic III '14->, fijac. panel puerta Megane III, Scenic III, Trafic III '14->, Twingo III (ver Fiat, Opel, PSA)	163.882	7703 081 232
10	Taco fijac. tapizados interiores Laguna III, Megane III, Scenic III (ver Dacia, PSA)	163.883	7703 081 225
10	Taco fijac. pilotos traseros Clio III, Kangoo '08, Megane II y III (ver Nissan)	164.101	7684 851 S00
25	Taco fijac. parachoque traseo Captur, Trafic III '14-> (ver Dacia)	164.361	7703 081 239
25	Taco fijac. rejilla parabrisas "torpedo" Captur	164.629	7703 081 214

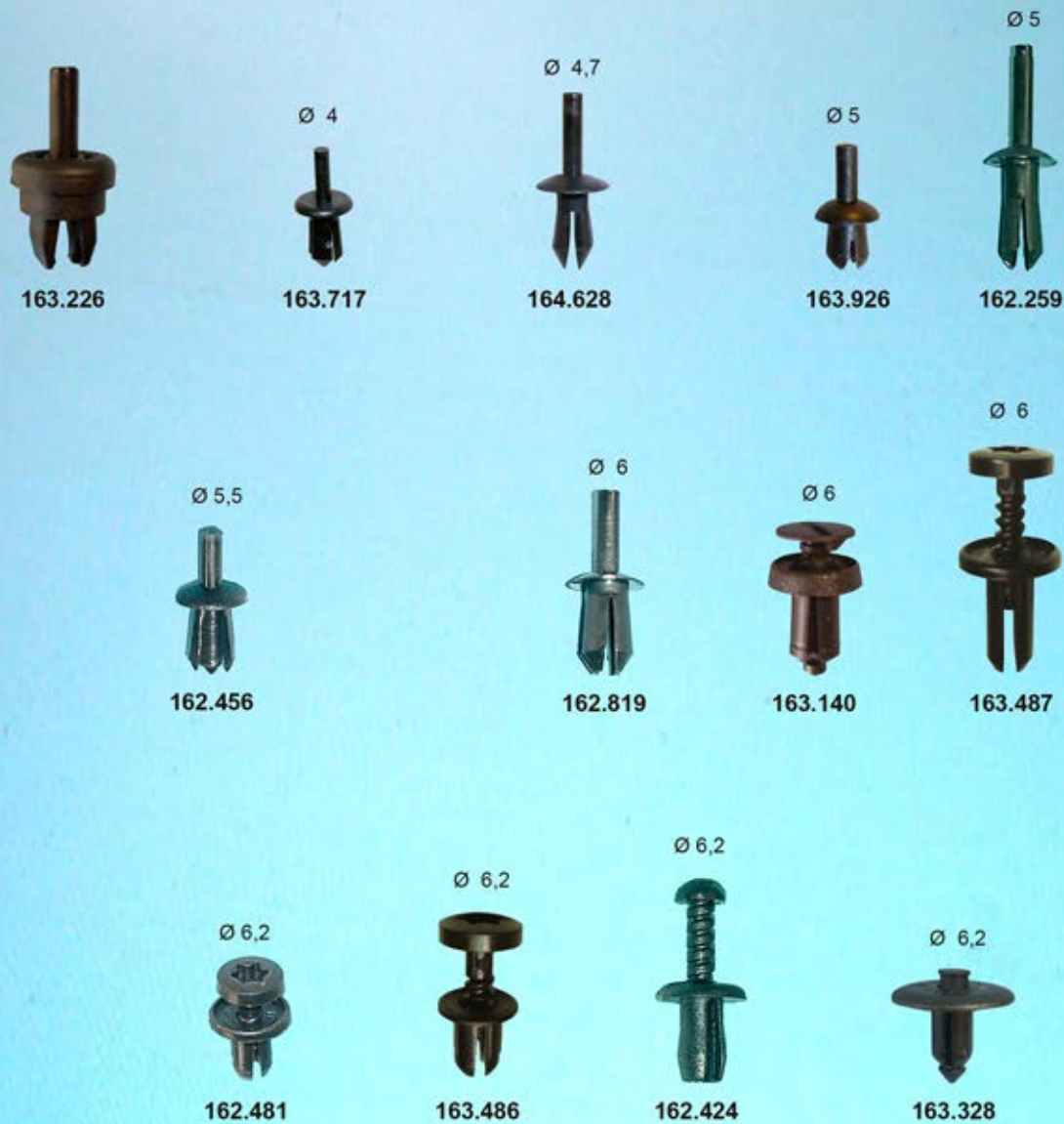

U.E.	DESCRIPCION	261	Ref. Adaptable
100	Remache fijac. pasoruada R-4, R-5, R-9, R-11, Super-5, Express, Master, Traffic, Espace (ver Mercedes)	162.259	7703 072 144
50	Remache fijac. varios usos Super-5, Express (ver Fiat, Mercedes, PSA, VAG)	162.424	7703 072 220
50	Remache fijac. revestim. interiores R-5, R-19, Super-5, Express (ver BMW, Mercedes, PSA, VAG)	162.456	7703 072 116
50	Remache fijac. junta puerta Laguna III, y otros usos R-19, R-21, Super-5, Express, Kangoo, Laguna (ver PSA)	162.481	7703 072 236
100	Remache fijac. embellecedor exterior del retrovisor Twingo II (ver Opel)	162.819	7703 072 172
50	Remache fijac. rejilla parabrisas "torpedo" Clio III, Laguna III, Latitude, Talisman, Trafic II, fijac. pasoruada Megane II, fij. moldura superior aleta Twingo II, fij. moldura ventanilla Espace V '15, fijac. tapiz. interiores Renault varios modelos (Eurocode 6300ASCVBK) (ver Dacia, Fiat, Opel)	163.140	7703 072 361
25	Remache fijac. portón trasero puerta Clio II, Clio III, Laguna, Megane II, Scenic II	163.226	- sin despiece -
25	Remache fijac. rejilla calandra y tapizados interiores Trafic II, fijac. moldura portón Espace IV	163.328	7703 072 352
50	Remache fijac. varios usos (ver PSA)	163.486	7703 072 327
50	Remache fijac. varios usos (ver Mercedes, PSA)	163.487	7703 072 261
100	Remache fijac. varios usos (ver PSA)	163.717	7703 072 224
50	Remache fijac. varios usos (ver Mercedes, Opel, Volvo)	163.926	7703 072 173
50	Remache fijac. rejilla parabrisas "torpedo" Master II 03->'10	164.628	7703 072 239

$\varnothing 7,5$

164.537
 $\varnothing 8$

163.306
 $\varnothing 8$

163.384
 $\varnothing 8$

163.091
 $\varnothing 8$

163.448
 $\varnothing 8$

164.230
 $\varnothing 8$

163.449
 $\varnothing 8,2$

163.088
 $\varnothing 8,2$

164.254

U.E.	DESCRIPCION	261	Ref. Adaptable
50	Fij. aletas y rejilla calandra Clio III, Espace IV, Fluence, Laguna III, fijac. pasoruada y parachoques Clio III, Kangoo II, Laguna III, Megane II, Scenic II, fijac. tapizados interiores Clio II, Espace IV, Laguna II, Vel Satis (ver Dacia, Nissan, Opel)	163.088	7703 072 360 7703 081 217
50	Remache fijac. revestimientos interiores Scenic (ver Chrysler, Ford, Land Rover, Opel, VAG)	163.091	7701 049 271
50	Remache fijac. varios usos (ver Ford, VAG)	163.306	7703 072 502
10	Remache fijac. parachoques Twingo y otros usos Clio I, Espace IV, Vel Satis	163.384	7703 072 345
25	Remache fijac. tapizados interiores Kangoo	163.448	
25	Remache fijac. tapizados interiores Laguna II, Scenic II	163.449	
10	Remache fijac. moldura aleta Koleos II (ver Mazda, Nissan)	164.230	7698 434 48R 0155 305 933
25	Remache fijac. rejilla parabrisas "torpedo" y otros usos Clio IV '12->, Espace V '15->, Kadjar '15->, Master '10->, Megane III y IV '08->, Scenic III y IV '08->, Trafic III '14->, Twingo III '14-> (ver Dacia, Nissan)	164.254	0540 000 01R
10	Remache fijac. tapizados interiores Scenic IV '16->	164.537	908B 868 23R



163.123



163.131



163.132



164.194



164.195



162.947



163.169



163.035



163.036



163.037

U.E.	DESCRIPCION	261	Ref. Adaptable
25	Fijac. moldura parabrisas Rover 200/400 (ver Honda) (Eurocode 7016ASCHB)	162.947	DCC 10010
50	Fijac. pasoruada Rover 400 (ver Honda)	163.035	
10	Fijac. parrilla parabrisas Rover 400 '95->, Rover 600 (Eurocode 3936ASCHB/7020ASCSS4B) (ver Honda)	163.036	
50	Fij. parachoques Rover 25, fijac. pasoruada Rover 75, fijac. revestimiento parachoques Rover 400 (ver BMW, Daewoo, Honda, Mini)	163.037	DYQ 100230 DYQ 100230A
25	Fijac. moldura parabrisas Rover 400, 45, MG ZS (Eurocode 3940/3948ASCS/ASCCTS7B) (ver Honda)	163.123	
10	Fijac. moldura parabrisas Rover 400, 45 y MG ZS (Eurocode 3954ASCH) (ver Honda)	163.131	DCC 100190
10	Fijac. moldura parabrisas Rover 600 (Eurocode 3936ASCSS6B) (ver Honda)	163.132	
10	Fijac. talonera puerta Rover 45- (ver Honda)	163.169	DCC 100190
10	Fijac. moldura lateral parabrisas Rover 75 (Eurocode 7035ASCST)	164.194	DCC100310
10	Fijac. moldura lateral parabrisas Rover 75 (Eurocode 7035ASCSS)	164.195	DCC100320



U.E.	DESCRIPCION	261	Ref. Adaptable
25	Fijac. molduras laterales 600/850	161.425	BD-59039600
10	Tornillo fijac. parachoques Panda (Ø 6 mm.)	161.430	SE-141563390A
50	Tornillo fijac. placa matrícula 127	161.431	NR-17670101
10	Tornillo para resbalón 127	161.440	NR-13325821
50	Fijac. manecilla alzacristales 600, 124, 127 (ver Fiat)	161.448	FA-52143600
25	Tornillo fijac. parachoques Panda (Ø 6 mm.) (ver Fiat)	162.356	
25	Tornillo fijac. parachoques Panda (Ø 8 mm.) (ver Fiat)	162.357	
25	Tuerca fij. parachoques Panda, Ritmo (monta con 162.363) (ver Fiat)	162.359	
25	Tornillo fij. parachoques Panda, Ritmo (monta con 162.359) (ver Fiat)	162.363	
10	Fijac. (c/inserto zincado) guardabarros Ritmo, Panda	162.364	
5	Tope parachoques Panda (ver Fiat)	162.400	
25	Bloqueador tornillo 131	162.564	NR-14219290
5	Tope parachoques Ibiza, Toledo	162.567	
10	Tope (goma) capó Seat	164.378	
-	Tirante bandeja posterior Panda, Ritmo (long.total 400 mm.)	181.403	
5	Surtidor lavaparabrisas Seat 127	190.021	4400321
5	Surtidor lavaparabrisas Seat Panda	190.022	4432041



162.563



162.428



162.360



162.557



162.679



162.598



162.402



162.553



162.378



162.599



162.615



162.493



162.823



162.579
gris



162.580
negro

U.E.	DESCRIPCION	261	Ref. Adaptable
25	Fijac. moldura lateral Fura, Panda	162.360	00.05940037
100	Fijac. panel puerta 127, 131, Ritmo (ver Fiat)	162.378	NR-14187480
100	Fijac. panel puerta Panda	162.402	
25	Fijac. moldura talonera 850, 1430	162.428	
100	Fijac. tapizados Seat - varios modelos - (ver Fiat)	162.493	NR-14592587
50	Fijac. panel puerta Seat - varios modelos - (color blanco)	162.553	NR-14187980
25	Fijac. molduras Seat	162.557	
25	Fijac. moldura lateral 131 Supermirafiori	162.563	4401310
100	Fijac. tapizados interiores Panda (Gris)	162.579	
100	Fijac. tapizados interiores Panda (Negro)	162.580	00.08235646
50	Fijac. panel puerta Ritmo, 132 (ver Fiat)	162.598	GA-55819410
25	Contrabroche panel Panda	162.599	00.04412934
10	Fijac. tapizados Ritmo	162.615	00.04461409
25	Fijac. molduras 124/127 (ver Fiat)	162.679	FC-59018000
100	Fijac. tapizados Seat (ver Renault)	162.823	



U.E.	DESCRIPCION	261	Ref. Adaptable
100	Tuerca rápida varios usos Seat (ver Fiat, Ford, Mercedes, Renault)	162.238	NR-14201980
100	Tuerca rápida varios usos 131, Ritmo (Ver Fiat)	162.240	
50	Fijac. faro delantero 127 y trasero Panda	162.241	
25	Fijac. varios usos 127, Panda (ver Fiat)	162.242	NR-14202782
25	Fijac. varios usos 127, Panda (ver Fiat)	162.243	NR-14202985
50	Fijac. faro 127, 131, Ritmo (ver Fiat)	162.247	NG-20502815
50	Fijac. faro 127, 131, Ritmo (ver Fiat)	162.248	
100	Tuerca rápida varios usos Seat (ver Fiat)	162.326	NR-14215480
50	Fijac. parrilla delantera 127, 131, 132	162.401	HH-53008000
25	Grapa fijación rápida 3 mm. varios usos Seat	162.449	NR-14188880
25	Fijac. tapicería 127	162.457	NR-14203080
25	Fijac. luz matrícula 127, 132, 133	162.491	HB-93981000
25	Fijac. autoroscante Seat - varios modelos -	162.492	NR-14199688
25	Regulador faro 127, 131, 132, Ritmo	162.494	NG-01746109
25	Fijac. tubos universal Seat	162.499	
25	Fijac. faro delantero Panda (ver Fiat)	162.533	
50	Tuerca rápida varios usos Seat (ver Fiat)	162.534	NR-14202383
50	Fijac. autoroscante rejilla 127, Panda (ver Fiat)	162.545	NR-14203680
25	Fijac. tubos Seat	162.608	00.04292588
50	Fijac. placa matrícula, modelos antiguos	162.609	HB-56625000
25	Fijac. letreros 131	162.610	LF-89016600



162.565 *- Dcho.
162.566 *- Izdo.

181.432 *- Del. Dcha.
181.433 *- Del. Izda.
181.434 *- Tras. Dcha.
181.435 *- Tras. Izda.

* (imagen NO a tamaño real)

U.E.	DESCRIPCION	261	Ref. Adaptable
10	Fijac. varilla capó Panda (ver Fiat)	162.273	
25	Fijac. aislante motor 124, 131	162.325	FC-55609200
25	Fijac. reenvío manecilla Ritmo, Panda, Marbella (ver Fiat)	162.427	NR-14578083
10	Fijac. tubo freno Seat (Ø 7 / 7)	162.520	00.04442520
10	Fijac. tubos Seat (Ø 8)	162.532	00.04472197
10	Fijac. tubo freno Seat	162.538	
25	Fijac. punta parachoques 131	162.541	
10	Tapón carrocería Panda	162.542	
5	Bisagra cristal lateral Tras. Dcho. Ibiza hasta '92 (3 puertas)	162.565	
5	Bisagra cristal lateral Tras. Izdo. Ibiza hasta '92 (3 puertas)	162.566	
25	Fijac. cables Ritmo, Ibiza (Ø 5 / 25)	162.568	00.05978963
10	Fijac. parrilla 131	162.571	JA-53008000
10	Tapón tensor asiento posterior Panda	162.640	00.04424781
10	Tapón taladros Panda	162.641	00.04450794
-	Guía sujeta cristal Panda (largo: 68 cm.)	181.400	4483981
-	Guía sujeta cristal 127 2 puertas (largo: 37 cm.)	181.401	4255534
-	Guía sujeta cristal Ibiza 3 puertas, Delantera (largo: 33 cm.)	181.431	SE-021521358A
-	Guía sujeta cristal Ibiza 5 puertas, Delantera Derecha (largo: 30 cm.)	181.432	SE-021521358B
-	Guía sujeta cristal Ibiza 5 puertas, Delantera Izquierda (largo: 30 cm.)	181.433	SE-021521359A
-	Guía sujeta cristal Ibiza 5 puertas, Trasera Derecha (largo: 30 cm.)	181.434	SE-021522358A
-	Guía sujeta cristal Ibiza 5 puertas, Trasera Izquierda (largo: 30 cm.)	181.435	SE-021522359A



173.080

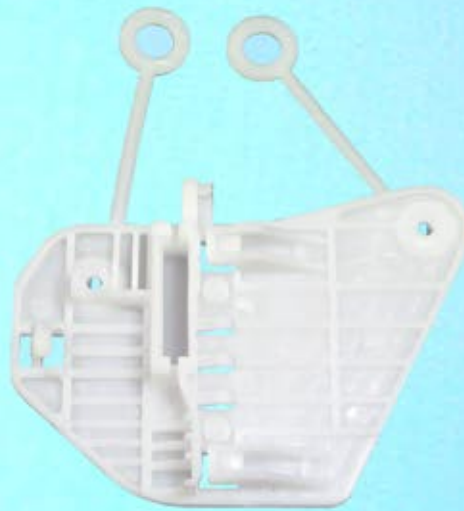

164.490 - Dcho.
164.491 - Izdo.



163.339



164.027



164.631



tornillo Ø 5

163.830



8 x 8
tornillo Ø 4

164.124



Ø 6

163.485

Ø 6
cabeza Ø 15



163.044

U.E.	DESCRIPCION	261	Ref. Adaptable
50	Fijac. talonera puerta (ver BMW, Land Rover, Mercedes, Mini, VAG)	163.044	
10	Fijac. parachoques Smart ForTwo	163.339	0001781V002000
50	Fijac. pasoruada Smart ForTwo (ver Mercedes, PSA, VAG)	163.485	A000 991 66 40
50	Fijac. bajos carroceria Smart ForTwo (Ver Dacia, Fiat, Ford, Mercedes)	163.830	A002 990 53 50
25	Fijac. panel puerta Smart ForTwo (ver Mercedes, VAG)	164.027	A011 988 76 78
25	Taco fijac. parachoque trasero Smart Fortwo (ver Mercedes)	164.124	A000 998 25 85
1	Soporte cristal elevalunas derecho Smart '98->'06	164.490	
1	Soporte cristal elevalunas izquierdo Smart '98->'06	164.491	
25	Fijac. panel puerta Smart '04-> (W454)	164.631	A000 991 14 98
1	Regulador eléctrico faro Smart ForTwo (ver Fiat, Ford, VAG)	173.080	



U.E.	DESCRIPCION	261	Ref. Adaptable
10	Fijac. tapizados interiores -varios modelos- (ver Lexus, Mitsubishi, PSA, Suzuki, Toyota)	163.161	909130105
50	Fijac. pasoruada y otros usos Impreza (ver Nissan)	163.276	57728AC090
25	Fijac. rejilla parabrisas "torpedo" Justy II (ver Mitsubishi, PSA, Suzuki, Toyota, Volvo)	163.300	
10	Fijac. rejilla radiador Forester	163.477	91017AA010
10	Fijac. rejilla radiador Forester	163.478	91017FA080
10	Fijac. moldura parabrisas Subaru Impreza '93->'98, Forester (Eurocode 7915ASCHS)	163.479	91017FA010
10	Fijac. moldura puerta Legacy '00->, Outback '00->	164.221	909130008
10	Fijac. tapizados interiores Subaru (ver Toyota)	164.242	
25	Fijac. rejilla parabrisas "torpedo" Forester '09, Impreza '08->, Legacy '10->, Outback '08-> (Eurocode 7934ASCRB)	164.355	91486KJ010
25	Fijac. insonorizante motor Impreza, Legacy	164.426	90814FC001
10	Fijac. moldura puerta Forester, Impreza, Legacy	164.427	909130088
10	Fijac. moldura pilar A Forester '13->, Legacy '14->, Outback '14-> (Eurocode 7934ASCRB)	164.525	909150031
10	Fijac. pasoruada y otros usos Legacy '08->, Outback '06->	164.577	91084AA010
10	Fijac. rejilla parabrisas "torpedo" Impreza (Eurocode 7932ASCHB)	164.589	909130051
10	Fijac. rejilla parabrisas "torpedo" Forester '07->, Legacy '13->, Stella '10 (Eurocode 7936ASCSB)	164.666	91486KJ000
10	Fijac. pasoruada Forester '14->, Legacy '15->, XV '14->	164.711	909140068
10	Fijac. aleta delantera Forester '98->'05	164.826	57160FC010

164.777 - Izdo.

164.776 - Dcho.

164.779 - Izdo.

164.778 - Dcho.

U.E.	DESCRIPCION	261	Ref. Adaptable
1	Soporte parachoques delantero derecho Swift '10->	164.776	71731-71L00
1	Soporte parachoques delantero izquierdo Swift '10->	164.777	71732-71L00
1	Soporte parachoques trasero derecho Swift '10->	164.778	71821-71L01
1	Soporte parachoques trasero izquierdo Swift '10->	164.779	71822-71L01
1	Bomba lavaparabrisas varios modelos (ver Honda, Hyundai, Mazda, Mitsubishi, Subaru, Toyota)	190.363	

164.285

164.423

163.161

163.509

163.250

163.531

163.616

163.514

163.617

163.513

163.510

163.512

U.E.	DESCRIPCION	261	Ref. Adaptable
25	Fijac. panel puerta Swift, SX4 '06->, fij. moldura puerta Grand Vitara (ver Lexus, Mitsubishi, PSA, Subaru, Toyota)	163.161	09409-10312
25	Fijac. panel puerta y tapizados interiores - varios modelos - (ver Lexus, Toyota)	163.250	09409-08320-000
25	Fijac. tapizados interiores - varios modelos -	163.509	
25	Fijac. tapizados interiores - varios modelos -	163.510	
25	Fijac. tapizados interiores - varios modelos -	163.512	
25	Boca fijac. varios usos - varios modelos -	163.513	
25	Fijac. tapizados interiores - varios modelos -	163.514	
10	Fijac. tapizados - varios modelos - (ver Mazda, Toyota)	163.531	89422-64920
25	Fijac. revestimientos interiores Jimny, Vitara, Grand Vitara, fijac. spoiler Jimny fijac. parachoques delantero Grand Vitara, Swift	163.616	09409-08322-000
10	Fijac. moldura lateral Liana, Vitara, Gran Vitara	163.617	09409-10309-000
25	Fijac. moldura aletas y talonera puerta SX4 '06-> (ver Fiat)	164.285	09409-08328
10	Fijac. moldura inferior puerta Ignis, Wagon R+, fijac. tapizados interiores Grand Vitara	164.423	77259-71B00



164.419



163.248



163.852



163.866



164.736



163.300



163.301



163.475



164.815



163.302



163.476



164.153



163.814

U.E.	DESCRIPCION	261	Ref. Adaptable
10	Fijación rejilla parabrisas "torpedo" SX4 '06->, fijac. moldura puerta Grand Vitara (Eurocode 3363ASCR) (ver Fiat, Toyota)	163.248	77553-65D10 77553-65D00
25	Fijac. rejilla parabrisas "torpedo" Grand Vitara, Swift (Eurocode 8011ASCH / 8010ASCR) (ver Mitsubishi, PSA, Subaru, Toyota, Volvo)	163.300	09409-07308-5PK
25	Fijac. tapizados interiores - varios modelos -	163.301	09409-07325-5PK
10	Fijac. tapizados interiores - varios modelos -	163.302	09409-07303-5ES
10	Fijac. tapizados interiores - varios modelos -	163.475	09409-07305-5PK
25	Fijac. parachoques, pasoruada, bajos carrocería y talonera puerta Aerio/Liana '02, Grand Vitara, Jimny, Swift, SX4 '06	163.476	09409-07332-000
25	Fijac. talonera puerta Aerio/Liana '02->, Swift, SX4 '06-> (ver Chevrolet, Fiat)	163.814	09409-15302-000
10	Fijac. moldura inferior parabrisas Swift '05->, SX4 '06-> (Eurocode 6291ASCV) (ver Fiat, Opel)	163.852	84618-76G10
10	Fijac. moldura lateral parabrisas Swift '05-> (Eurocode 8031ASCHS / 8032ASCHS)	163.866	77150-63J10
25	Fijac. parachoque Swift '05-> (ver Fiat)	164.153	09409-08327
25	Fijac. rejilla parabrisas "torpedo" Escudo, Grand Vitara, Vitara (Eurocode 8020ASCRB)	164.419	83943-86000
25	Fijac. panel puerta Vitara '12->, fijac. parrilla radiador Vitara '99->	164.736	09409-06314-5PK
25	Fijac. parachoques y bajos carrocería Grand Vitara '05 y '12->, Swift '05->, SX4 '06->	164.815	09409-07340-000

Ø 5 x 17
arandela Ø 16



161.835

Ø 5,2 x 19
arandela Ø 12



161.846

Ø 6,2 x 17
arandela Ø 16



161.850

Ø 6,2 x 22
arandela Ø 18



161.847

Ø 6,3 x 16
arandela Ø 16



161.829

Ø 6,3 x 20
arandela Ø 20



161.827

Ø 6,3 x 24
arandela Ø 16



161.820

Ø 3,8 x 6,2

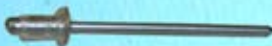

161.845

Ø 4 x 8



161.849

Ø 4 x 13



161.871

U.E.	DESCRIPCION	261	Ref. Adaptable
25	Tornillo Ø 6,3 x 24 (aro Ø 16), parachoques Auris '07, Avensis '03, Camry '06, Celica, Corolla ->'06	161.820	90159-60488
25	Tornillo Ø 6,3 x 20 (aro Ø 20), parachoques y bajos carroceria Avensis '03, Aygo, Rav 4 '00->'05, Yaris '99 y '06-> (ver PSA)	161.827	90159-60383
25	Tornillo Ø 6,3 x 16 (aro Ø 16), parachoques Yaris '99->'05, '05->'11 y '11->, Corolla '02->, fijac. spoiler Prius '03->'09 y '09->, Rav 4 '05->'11 y '12->	161.829	90159-60498
25	Tornillo Ø 5 x 17 (aro Ø 16), parachoque Auris '07, Corolla '01->'06, fij. pasoruada Avensis '97->'03, fijac. faro Avensis '03->	161.835	90159-50311
25	Remache Ø 3,8 x 6,2, fijac. juntas puerta Avensis '08->, Prius '15-> (ver Lexus)	161.845	90269-04051
25	Tornillo Ø 5,2 x 19 (aro Ø 12), fijac. parachoques Auris '12->, Rav 4 '05 y '12-> (ver Lexus)	161.846	75392-42030
25	Tornillo Ø 6,2 x 22 (aro Ø 18), fijac. pasoruada Avensis '08->, C-HR '17->, Prius '09->, Verso '09->, fijac. bajos carroceria Corolla '01->'07, Rav 4 '12->, fijac. parachoque Land Cruiser '98->'07	161.847	90159-60477
25	Remache Ø 4 x 8, fijac. moldura parabrisas Land Cruiser '98->'07 (Eurocode 8306ASSRS)	161.849	90269-04053
10	Tornillo Ø 6,2 x 17 (aro Ø 16), fijac. parachoques Auris '07->, Camry '06->, Land Cruiser '02->	161.850	90159-60431
10	Remache Ø 4 x 13, fijac. moldura parabrisas C-HR '17->, Prius '15-> (ver Lexus)	161.871	75547-51021



163.706



163.359



164.417



164.619



164.840



163.130



164.020



163.122



164.019



164.819



163.859



163.300

Ø 6,5

Ø 6,5

U.E.	DESCRIPCION	261	Ref. Adaptable
10	Fijac. "torpedo" parabrisas Toyota Auris, y fij. juntas puertas Auris, Avensis, Celica, Corolla, IQ, Prius, Starlet, Yaris	163.122	67867-12150
10	Fijac. moldura parabrisas Toyota Camry '91->'96, Carina ->'92 (Eurocode 8262ASCH)	163.130	75548-20110
25	Fijac. rejilla parabrisas "torpedo" Aygo '14-> (Eurocode 8011ASCH / 8010ASCR)	163.300	90467-07041
10	Fijac. moldura parabrisas Toyota Avensis '03->'08, Aygo, Camry, Celica, Corolla '01->'06, IQ, Land Cruiser, Prius, Rav 4 '00 y '05, Yaris '99 y '05-> (Eurocode 8310ASCH) (ver Lexus)	163.359	56115-30100
10	Fijac. moldura superior parabr. Toyota Auris, Avensis '03->, Aygo, Camry, Celica, Corolla '01, Verso, IQ, Land Cruiser, Prius, Rav 4 '00->, Urban Cruiser, Yaris (Eurocode 8310ASCH6B) (ver Lexus)	163.706	56116-22050
10	Fijac. rejilla parabrisas "torpedo" Avensis '97->'03 (Eurocode 8305ASCH6B)	163.859	90467-07188
10	Fijac. rejilla parabrisas "torpedo" Avensis '97->'03 (Eurocode 8305ASCH)	164.019	90467-08218
10	Fijac. rejilla parabrisas "torpedo" Avensis '97->'03, Corolla '01->'06 (Eurocode 8304ASCHB) (ver Lexus)	164.020	90467-08108
10	Fijac. moldura lateral parabrisas Land Cruiser Prado '09-> (Eurocode 8394ASCRES)	164.417	75545-53011
10	Fijac. moldura lateral parabrisas Prius '15-> (Eurocode 8407ASCSS / 8422ASCHS1) (ver Lexus)	164.619	75545-30170
25	Fijac. moldura inferior parabrisas C-HR '17-> (ver Lexus)	164.819	90467-10204
10	Fijac. moldura lateral parabrisas C-HR '17-> (Eurocode 8421ASCRES)	164.840	75545-F4020



163.246



163.159



163.355



164.206



163.523*



163.524*



163.525*



163.895



164.186



164.188



164.291



164.241

* (imagen 1/2 tamaño real)

U.E.	DESCRIPCION	261	Ref. Adaptable
25	Fijac. parrilla radiador Celica, Corolla, HiLux, Land Cruiser ->'01 (ver Honda, Mazda, Opel)	163.159	90467-12020
5	Fijac. parrilla radiador Rav 4 '00->'05	163.246	53145-42010
10	Fijac. junta gomas puerta Yaris '99->'05 y '05->, Yaris Verso, HiLux '05->, Urban Cruiser '09, fijac. parrilla radiador Corolla Verso '04->'09	163.355	67867-52010
2	Fijac. parachoques trasero Carina E T19 '92->'97	163.523	52155-21020
2	Fijac. parachoques trasero Carina E T19 '92->'97	163.524	52155-21010
2	Fijac. parachoques trasero Picnic XM10 '96->'01	163.525	52155-44010
10	Fijac. parachoques trasero Yaris '99->'05	163.895	52565-52010
25	Fijac. parachoques Camry '05, Verso '10->, fijac. pasoruada Auris '07->, Corolla '06->, Prius '09->	164.186	47749-58010
10	Fijac. parachoques Auris '07, Avensis '08, Camry, Corolla '06, Land Cruiser '02 y '09, Verso '10, fijac. pasoruada Prius '09-> (ver Lexus)	164.188	53879-58010
10	Fijac. junta gomas puerta Auris '07->, Avensis '03->, Camry '01->, Celica, Corolla (ver Honda)	164.206	67867-12150
10	Fijac. parachoque Corolla '01->'06, Hi-Ace, Hi-Lux, Land Cruiser '07->, Prius '09->, Rav 4 '05->'12	164.241	75392-35200
10	Fijac. pasoruada Avensis Verso '01->, Previa '00->'06, Rav 4 '05->	164.291	53879-28010

261/

164.339 *- Izdo.



164.338 *- Dcho.



164.349 *- Izdo.



164.348 *- Dcho.



164.753 *- Izdo.



164.752 *- Dcho.



164.755 *- Izdo.



164.754 *- Dcho.

* (imagen 1/2 tamaño real)

U.E.	DESCRIPCION	261	Ref. Adaptable
1	Soporte parachoques delantero derecho Rav 4 '06->'13	164.338	52535-42021
1	Soporte parachoques delantero izquierdo Rav 4 '06->'13	164.339	52536-42021
1	Soporte parachoques delantero derecho Yaris '06->'11	164.348	52535-0D030
1	Soporte parachoques delantero izquierdo Yaris '06->'11	164.349	52536-0D030
1	Soporte parachoques delantero derecho Yaris '11->	164.752	52535-0D090
1	Soporte parachoques delantero izquierdo Yaris '11->	164.753	52536-0D090
1	Soporte parachoques trasero derecho Yaris '11->'14	164.754	52155-0D050
1	Soporte parachoques trasero izquierdo Yaris '11->'14	164.755	52156-0D040

163.935

163.936

163.937

163.938

163.939

163.940

164.244

164.245

163.526

163.247

163.932

U.E.	DESCRIPCION	261	Ref. Adaptable
10	Fijac. moldura pasoruada trasero Rav 4 '00->'05	163.247	75494-42010
10	Fijac. revestimientos interiores - varios modelos - (ver Lexus)	163.526	75397-48030
10	Fijac. moldura aleta trasera Rav4 '94->'00	163.932	75498-42010
10	Fijac. moldura aleta trasera Land Cruiser '02->'09	163.935	75394-60030
10	Fijac. moldura aleta trasera Land Cruiser '02->'09	163.936	75492-60020
10	Fijac. moldura aleta trasera derecha Land Cruiser '02->'09	163.937	75881-60010
10	Fijac. moldura aleta trasera izquierda Land Cruiser '02->'09	163.938	75883-60010
10	Fijac. moldura aleta trasera derecha Land Cruiser '02->'09	163.939	75882-60010
10	Fijac. moldura aleta trasera izquierda Land Cruiser '02->'09	163.940	75884-60010
10	Fijac. moldura aleta derecha Land Cruiser '02->'09	164.244	75398-60021
10	Fijac. moldura aleta izquierda Land Cruiser '02->'09	164.245	75491-60011



163.527



163.248



163.933



163.934



163.941



163.942



164.819



164.420



164.602



164.613



164.710



164.816



163.931



163.982



164.431

U.E.	DESCRIPCION	261	Ref. Adaptable
10	Fijac. parachoques y portón trasero Rav 4 '94->'05, fijac. portón trasero Yaris Verso '99->'05 (ver Fiat, Suzuki)	163.248	90467-11063
10	Fijac. revestimientos interiores - varios modelos - (ver Lexus)	163.527	75395-33030
10	Fijac. moldura portón trasero Rav 4 '05->, fij. aleta delantera y moldura lateral Land Cruiser '02->'09	163.931	75397-35010
10	Fijac. moldura lateral Land Cruiser '02->'09	163.933	75392-60031
10	Fijac. moldura lateral Land Cruiser '02->'09	163.934	75495-35010
10	Fijac. moldura aletas Hi-Lux '97->'05 y '05->, fijac. moldura lateral y aletas 4Runner '95->'02	163.941	90904-67037
10	Fijac. moldura aletas Hi-Lux '97->'05 y '05->, fijac. moldura lateral y aletas 4Runner '95->'02	163.942	90904-67036
10	Fijac. moldura inferior puerta Avensis '03->'08 (ver Lexus)	163.982	75867-30110
25	Fijac. moldura inferior puerta Avensis '03->'08, Camry '01 y '06->, Corolla '02->'06, fijac. tapizados interiores Hi Ace '05->	164.420	75867-33030
25	Fijac. moldura aleta delantera IQ	164.431	55799-74020
10	Fijac. moldura aleta Rav 4 '13->, fijac. tapizados interiores Land Cruiser '07-> (ver Lexus)	164.602	76817-68010
10	Fijac. moldura lateral Rav 4 '13->, Yaris '14->, Highlander '14-> (ver Lexus)	164.613	62955-50010
10	Fijac. moldura aleta C-HR '17->, Rav 4 '13-> (ver Lexus)	164.710	90467-08225 90467-08224
25	Fijac. moldura puerta C-HR '17->, fijac. spoiler trasero Rav 4 '13->	164.816	55799-74020
25	Fijac. soporte aleta Hilux '15-> (ver Lexus)	164.819	90467-10204

163.532

163.253

163.162

163.533

163.534

164.242

163.161

164.395

164.421

163.354

163.621

U.E.	DESCRIPCION	261	Ref. Adaptable
25	Fijac. tapizados interiores Avensis, Auris, Aygo, Camry, Celica, Corolla, Hilux, IQ, Land Cruiser, MR2, Previa, Rav4, Verso, Yaris (ver Lexus, Mitsubishi, PSA, Subaru, Suzuki)	163.161	90467-10161 90467-09206
25	Fijac. moldura base retrovisor y talonera puerta Aygo, Avensis '03, Corolla '01, Yaris '99->'05 y '05-> fijac. aletas y moldura portón trasero Rav 4 '05->, fijac. tapiz. interiores Celica, HiAce (ver Lexus)	163.162	90467-10162
25	Fijac. panel puerta Carina E, Corolla ->'01, Corolla Verso '01->'03, Yaris '99->'05	163.253	67771-16170
25	Fijac. panel puerta Yaris '99->'05, Picnic, fijac. tapizados interiores Corolla '01, Avensis Verso '01, Land Cruiser	163.354	90467-10192
10	Fijac. tapizados interiores Celica, MR2, Picnic, Previa, Starlet, HiLux '97->'05, Land Cruiser '90->'07	163.532	67921-95501
10	Fijac. tapizados Camry, Cressida, MR2, Starlet, Land Cruiser ->'89	163.533	67771-22010
10	Fijac. parachoques y pasoruera trasero Land Cruiser Prado '02->'09	163.534	75493-60020
10	Fijac. tapizados interiores Auris '07, Camry '06->, Celica, Corolla '06->, IQ '08->, Land Cruiser '07->, Prius '09, Rav4 '00, Urban Cruiser '09, Verso-S, Yaris '05->, fijac. portón trasero Avensis '97->'08, Corolla '97->'06, fijac. moldura techo Avensis '08-> (ver Lexus)	163.621	90467-10167
25	Fijac. panel puerta Auris '07->, Camry '01 y '06->, Corolla '06-> (ver Subaru)	164.242	90467-09206
25	Fijac. panel puerta Aygo '05->'13, fijac. tapizados interiores Camry '06, Corolla '01 y '06-> (ver Mitsubishi)	164.395	90467-W0009 90467-10188
25	Fijac. tapizados interiores Auris '07->, Avensis '03->'08, Corolla '01->'06, Land Cruiser '02 y '07->, Prius '03->'10, Rav 4 '05->	164.421	62217-13010

164.599

164.430

164.625

163.531

163.620

163.250

164.673

163.528

163.251

163.254

163.356

163.535

164.525

164.556

U.E.	DESCRIPCION	261	Ref. Adaptable
25	Fijac. panel puerta y tapizados interiores Camry, Carina, Celica ->'99, Corolla ->'06, Hi-Lux, HiAce, Land Cruiser ->'07, Paseo, Previa, Prius '00->'03, Starlet, Yaris '99->'05, 4Runner (ver Lexus, Suzuki)	163.250	67771-12050
10	Fijac. moldura portón trasero Avensis '03->'08, Corolla '97->'07, Corolla Verso ->'09 (ver Lexus)	163.251	75819-12040
25	Fijac. revestimientos interiores Avensis '03->'08, IQ, Paseo, Verso-S, Yaris	163.254	90467-10023
25	Fijac. tapizados portón trasero Yaris (ver Lexus)	163.356	90467-05096
10	Fijac. moldura portón trasero Land Cruiser '02->'09, moldura ventanilla trasera Corolla ->'97, MR2, Starlet ->'99 (ver Lexus)	163.528	62955-12010
10	Fijac. tapizados interiores Celica, Corolla, HiAce, HiLux, Land Cruiser (modelos antiguos) (ver Mazda, Suzuki)	163.531	67771-12010 67771-01010
25	Fijac. tapizados - varios modelos -	163.535	90467-09084-01
10	Fijación tapizados interiores y panel puerta Avensis '97->'02, Corolla '97->'01, HiAce '95->, Land Cruiser '96->'02, MR2, Picnic, Previa, Prius '00->'03, Rav4 '94->'00, Yaris '99->'05	163.620	67771-30070
25	Fijac. panel puerta Aygo '14->, C-HR '17->, Corolla '13->, Highlander '14->, Verso '09-> (ver PSA)	164.430	67773-0E020
10	Fijac. tapizados interiores Auris '07, Avensis '08, Corolla '06->'13, Land Cruiser '07, Prius '03->'09, Rav 4 '00->'05 (ver Lexus, Subaru)	164.525	90950-08004
10	Fijac. tapizados interiores Auris '12->, Corolla '13->, Rav 4 '12->	164.556	62217-52120
50	Fijac. panel puerta delantera y trasera Aygo '14->, fijac. tapiz. interiores Corolla '13, Highlander '13 (ver PSA)	164.599	62489-0E010
25	Fijac. tapizados interiores Auris '07->, Camry, Yaris '06->	164.625	90467-A0033
10	Fijac. tope puerta Auris '12->, Avensis '03->, Aygo, Corolla '06 y '13->, Prius '09 y '15->, Yaris '11->	164.673	90541-09124

261/

9 x 9
Tornillo Ø 4,2



163.619

9 x 9
Tornillo Ø 5,5



163.256

9 x 9
Tornillo Ø 5,5



163.622

9 x 11
Tornillo Ø 5,5



164.290

8 x 8
Tornillo Ø 5,5



163.894

9 x 9
Tornillo Ø 5,5



164.738

9 x 9
Tornillo Ø 5,5



163.165

9 x 9
Tornillo Ø 5,5



164.091

8,8 x 9
Tornillo Ø 6,3



164.305

8 x 8,2
Tornillo Ø 5,5



163.121

8,2 x 8,2
Tornillo Ø 5,5



163.255

8,5 x 8,5
Tornillo Ø 4,8



163.520

8,5 x 8,5
Tornillo Ø 6,3



164.298

8 x 11,5



164.674



163.160



164.397

U.E.	DESCRIPCION	261	Ref. Adaptable
10	Fijac. pasoruada Toyota Celica, Corolla, Corona Land Cruiser ->'89	163.121	90189-06003
10	Fij. moldura pasoruada Camry, Carina, Celica ->'99, Corolla ->'97, MR2, Previa, Tercel (ver Lexus)	163.160	53879-14010
25	Fijac. pasoruada y parachoques Auris, Aygo '14->, Corolla, IQ, Prius '09->, Yaris (ver PSA, Lexus)	163.165	90189-06013 90189-06065
25	Fijac. tapizados portón trasero Land Cruiser ->'07 y otros usos - varios modelos -	163.255	90189-06005
25	Fijac. pasoruada trasero Aygo, Corolla, Prius, Verso-S, Yaris, fij. talonera puerta Celica, Corolla '01 (ver PSA)	163.256	90189-06006
10	Fijac. tapizados interiores - varios - (ver Honda, Mazda, Nissan)	163.520	90189-06042
25	Fijac. maneta interior Carina (ver Mazda)	163.619	90189-06010
25	Fijac. moldura guardabarros Corolla	163.622	90189-06226
25	Fijac. parachoques trasero Corolla '01->'06, fijac. bajos carroceria Prius '03->'09	163.894	90189-06224
25	Fijac. parachoques Prius '03->'09, fijac. pasoruada Corolla '01->'06, Hi-Ace, Rav4 '00->'05 (ver Lexus)	164.091	90189-06157
50	Fijac. pasoruada Auris '07, Yaris '11->, fij. parachoque Camry, Corolla '06->, Prius '09->, Rav 4 '05->	164.290	90189-06193
25	Fijac. pasoruada Avensis Verso '01->'09, Celica, Corolla '97->'01, Rav 4 '94->'00 y '05->	164.298	90189-06114
25	Fijac. spoiler delantero Auris '07->, Avensis '03->'08, Corolla '00->'06, Corolla Verso '04->	164.305	90189-05144
10	Fijac. pasoruada Aygo, Prius '03, Rav 4 '00->'05 y '05->, fijac. parachoque trasero Rav 4 '05->	164.397	90467-05114
25	Fijac. luz posterior Auris '12, Aygo '14, Corolla '06, Land Cruiser, Prius '12, Rav '12, Yaris '05 y '11	164.674	81496-52020
25	Fijac. pasoruada Aygo '06->'14, fijac. parachoque trasero Land Cruiser ->'01 (ver PSA)	164.738	90189-06047



U.E.	DESCRIPCION	261	Ref. Adaptable
25	Fijac. insonorizante capó Corolla '97->'06, Land Cruiser Prado '02->'09, Previa, Supra, Verso, Yaris '99->'05 y fijac alfombras Celica '99->'05 (ver Lexus)	163.193	90467-08124
25	Fijac. insonorizante capó Land Cruiser	163.194	90467-09008-01
25	Fijac. tapizados alfombras Yaris '99->'05, Verso	163.252	90467-10091
10	Fijac. aislamiento capó Cressida, Hi-Lux	163.257	90467-09004-01
10	Fijac. aislamiento capó Auris, Avensis '03->'08, Aygo, Camry, Corolla, IQ '08, HiAce, HiLux, Land Cruiser, Prius, Rav4 '05->, Verso, Yaris '05-> (ver Lexus, PSA)	163.258	90467-09050
25	Fijac. goma capó Avensis Verso, Camry, Carina E, Celica, Corolla, Cressida, MR2, Picnic, Prius, Starlet, Verso, Yaris (ver Lexus)	163.259	90467-08011
25	Fijac. goma capó Camry, Celica, Corolla, Land Cruiser ->'01, Starlet	163.260	90467-08030
25	Fijac. varios usos - varios modelos -	163.261	90467-09069-01
25	Fijac. varios usos - varios modelos -	163.262	90467-06161-01
10	Fijac. aislamientos capó Celica ->'99, Rav4 '00->'05	163.357	90467-08081
25	Fijac. goma capó Yaris '99->'05, Yaris Verso, HiLux '05->, Land Cruiser '96->'02 y '02->'09	163.536	90467-07175
10	Fijac. rejilla parabrisas "torpedo" Avensis '97->'03, Corolla '01->'06 (ver Lexus)	164.020	90467-08108
10	Fijac. talonera puerta Auris '07->, Corolla '01->'06, Prius '03->, Yaris '05->	164.243	76924-52021
10	Fijac. talonera puerta Auris '07->, Corolla '06->	164.422	76924-12030
25	Fijac. pasoruada Corolla '13, Hilux '15, Land Cruiser Prado '09, Prius '09, Yaris '11, Rav 4 '05 y '12	164.709	53857-47011
25	Fijac. parachoque delantero Aygo '14->, IQ '14->, Land Cruiser Prado '09->, Prius '09->'15, fijac. parrilla radiador Corolla '13->	164.734	53145-60030

261/



U.E.	DESCRIPCION	261	Ref. Adaptable
50	Fij. moldura pasoruada Avensis Verso ->'09, Camry '06, Corolla '97->'06, Corolla Verso '09, Picnic, Previa, Starlet, Yaris '99-> y '05->, Yaris Verso, HiAce, fijac. spoiler trasero Aygo (ver Lexus, PSA)	163.167	90467-07166
10	Fij. moldura pasoruada Rav 4 ->'05, Land Cruiser ->'07, fij. rejilla radiador Avensis '01 (ver Lexus)	163.249	53879-60010
25	Fijac. rejilla radiador Yaris '99->'05	163.295	90467-06198
25	Fijac. rejilla parabrisas Aygo '14->, y otros usos HiLux, MR2 (ver PSA, Subaru, Suzuki, Volvo)	163.300	90467-07041
25	Fijac. pasoruada Auris, Avensis '97->'02 y '08->, Camry, Corolla '01->'06 y '06->, Corolla Verso '09->, IQ '08, HiAce, Previa, Prius '03->'09, Yaris '99->'05 y '05->, Yaris Verso, fijac. bajos carrocería Avensis Verso '01->'09, Celica '99->'05, MR2, Rav4 '00->'05 (ver Fiat, Honda, Lexus, Suzuki)	163.476	90467-07164
25	Fijac. moldura pasoruada Auris, Avensis '03->'08 y '08->, Aygo, Corolla '06, Corolla Verso, Yaris '99, Rav4 '05, fij. bajos carrocería Auris, Avensis '03, Corolla '01, Prius '09, Rav4 '05 (ver Lexus, PSA)	163.529	90467-07201
25	Fijac. bajos carrocería Auris, Avensis '08, Corolla Verso '09, fijac. aleta Yaris ->'05, Yaris Verso (ver Lexus)	163.530	90467-07183
10	Fijac. talonera puerta 4Runner '06->, fijación rejilla parabrisas "torpedo" Avensis '97->'03 (Eurocode 8305ASCH6B)	163.859	90467-07188
10	Fijac. moldura pasoruada Auris, Avensis '03->'08 y '08->, Aygo, Corolla '06, Corolla Verso, Yaris '99, Rav4 '05, fij. bajos carrocería Auris, Avensis '03, Corolla '01, Prius '09, Rav4 '05	164.024	
25	Fijac. parachoque Verso '09->, Camry '06-> (ver Lexus)	164.087	90467-07117
25	Fijac. bajos carrocería Auris '07, Avensis '08, Corolla '06, Prius '09, Land Cruiser '07 (ver Lexus)	164.099	90467-07211
10	Fijac. parrilla radiador Avensis '03->'08	164.187	53259-20030
10	Fijac. talonera puerta Land Cruiser '02-'09, fij. tapiz. interiores Camry, Celica, Corolla (ver Lexus)	164.189	90467-07146
25	Fijac. parachoque Auris '07->, Corolla '06->	164.396	90467-05090B1
25	Fijac. parachoque Auris '12->, Avensis '08->, Aygo '14->, Corolla '06 y '13, Prius '15->, Rav 4 '13->	164.603	90467-05170
50	Fijac. pasoruada y bajos carrocería Auris '07 y '12->, Aygo '14, Corolla '06 y '13, IQ, Prius '09 y '15, Verso '09, Urban Cruiser, Yaris '06 y '11-> (ver PSA)	164.678	90467-07214
25	Fijac. parachoque delantero Aygo '05->'14, Auris '06->'12, Celica, Corolla '06->'13, Prius '09->'15, Verso-S '10, Yaris '11->	164.735	90467-05063-C0
10	Fijac. parachoque Avensis '03->'08, IQ, Urban Cruiser, Yaris '06->'11, fijac. tapizados Hilux '05->'15	164.737	90467-07071-22
25	Fijac. pasoruada y bajos carrocería Avensis '08->, C-HR '17->, Corolla '13->, Prius '09->, Rav 4 '05	164.817	90467-07215
10	Fijac. moldura aleta C-HR '17->, fijac. parachoque delantero Prius '15->, Rav 4 '13-> (ver Lexus)	164.822	90467-07220

261/



U.E.	DESCRIPCION	261	Ref. Adaptable
50	Fijac. parachoques Previa, Starlet, Verso, Yaris, fijac. pasoruada Verso, HiLux '97->'05, fijac. portón trasero Rav4 '00, fijac. spoiler parachoques delantero Celica '99->'05, Corolla '97->'01, fijac. parrilla radiador Aygo, Yaris Verso (ver Lexus, Nissan, PSA)	163.166	90467-08185
25	Fijac. parachoques Avensis ->'02, Carina, Celica, Corolla '92->'07, Corolla Verso ->'09 (ver Lexus)	163.296	90467-09093
25	Fijac. protectores de parachoques y pasoruada Land Cruiser '96->'02 y '02->'09 (ver Lexus)	163.297	90467-09189
25	Fijac. parachoques delantero y trasero y rejilla radiador Auris, Avensis '08->, Camry '96->'01, Celica, Corolla '01->'06 y '06->, IQ '08, Prius, '00->'09 y '09->, Verso-S '10->, Yaris '99->'05 y '05->, Yaris Verso, fijac. parachoques trasero Avensis '97->'08, Aygo, Urban Cruiser '09 (ver Lexus, PSA)	163.358	52161-16010
25	Fijac. pasoruada y parachoques Corolla -> '95, otros usos HiLux, 4Runner (ver Hyundai, Mazda)	163.503	90467-06017
10	Fijac. pasoruada delantero Avensis '03->'08, fijac. deflector aire delantero Aygo (ver Lexus, PSA)	163.981	90467-09128
25	Fijac. parachoque delantero Yaris '06-> (ver Lexus)	164.292	51454-48010
25	Fijac. parachoque Camry '00->'06 y '06->, fijac. faro Land Cruiser '98->'02 (ver Lexus, Volvo)	164.299	90467-08180
25	Fijac. bajos carroceria Auris '07->, Corolla '06->, Rav 4 '05->	164.312	90467-09227
25	Fijac. bajos carroceria Corolla '01->'06, Rav 4 '05-> (ver Nissan)	164.314	90467-08145
5	Fijac. talonera puerta Prius '09->	164.555	76923-47010
10	Fijac. rejilla radiador Rav 4 '05 y '12->	164.640	53384-68010
10	Fijac. spoiler puerta Avensis '08, Hilux '15, Urban Cruiser, Verso '09, Yaris '05	164.675	76923-52021

Ø 4,2 x 17
arandela Ø 14



162.702

Ø 4,8 x 15



161.477

Ø 4,8 x 15
arandela Ø 15



161.473

Ø 4,8 x 18
arandela Ø 15



161.474

Ø 5 x 16



161.764

Ø 5 x 16



161.789

Ø 5,5 x 19
arandela Ø 18



162.555

Ø 5,5 x 19
arandela Ø 22



161.742

Ø 6,3 x 18
arandela Ø 18



161.799

Ø 6,3 x 19
arandela Ø 18



162.556

Ø 6,3 x 19
arandela Ø 22



161.743

Ø 7 x 20



161.876

U.E.	DESCRIPCION	261	Ref. Adaptable
50	Tornillo Ø 4,8 x 15 (aro Ø 15), varios usos (ver BMW, Ford, Mercedes, Opel, PSA)	161.473	
50	Tornillo Ø 4,8 x 18 (aro Ø 15), varios usos (ver BMW, Ford, Mercedes, Opel, PSA)	161.474	
50	Tornillo Ø 4,8 x 15, fijac. pasoruada VW Golf III, Golf IV, Passat	161.477	N 907 750 01
50	Tornillo Ø 5,5 x 19 (aro Ø 22), sujeción guardabarros (ver BMW, Ford, Mercedes, Opel)	161.742	
50	Tornillo Ø 6,3 x 19 (aro Ø 22), sujeción guardabarros (ver BMW, Ford, Mercedes, Opel)	161.743	
25	Tornillo Ø 5 x 16, fijac. pasoruada y parachoques VW Caddy '04, Golf V, Phaeton, Touran, fijac. moldura puerta VW Passat '97, fijac. parachoques Seat Cordoba '03, VW Polo '02, y otros usos Audi A4, A6, A8, TT, VW New Beetle	161.764	N 103 546 01
50	Tornillo Ø 5 x 16, fijac. pasoruada Audi A3 '13, Q3, Seat Alhambra '11, Leon '13, Mii, fijac. bajos carroceria Seat Altea, Exeo, Leon '05, Skoda Octavia '05, fijac. parachoques Audi A1, A3 '03, A4 '13, A5, A6 '13, A7, Q5, Q7, Seat Mii, Leon '05, Toledo '05, Skoda Fabia '07, Yeti, VW Caddy '11, Golf VI y VII, Polo '09, Scirocco, Tiguan, Touran, UP	161.789	N 909 74 701 N 910 570 01
50	Tornillo Ø 6,3 x 18 (aro Ø 18), fijac. aletas Audi A3 '97->'03, VW Transporter '03, Amarok '10 fijac. faro Seat Ibiza '08->, Leon '13->	161.799	N10512701
25	Tornillo Ø 7 x 20, fijac. soporte radiador Audi A6 '11->, A7, fijac. soporte antichoque Passat '06->'15, fijac. cuerpo termostato Audi A2, Seat Altea, Arosa, Cordoba '93->'09, Ibiza '93->'15, Leon '99->'12, Toledo '99->'09, Skoda Fabia '00->'15, Octavia '97->'13, Roomster '06->'15, VW Caddy '96->'11, Golf V y VI '04->'13, Lupo, Polo '96->'00,	161.876	N 906 298 03
50	Tornillo Ø 5,5 x 19 (aro Ø 18), sujeción guardabarros (ver Ford, Opel)	162.555	
50	Tornillo Ø 6,3 x 19 (aro Ø 18), sujeción guardabarros (ver BMW, Ford, Mercedes, Opel)	162.556	311 821 143 N 905 426 02
25	Tornillo Ø 4,2 x 17 (aro Ø 14), fijac. pasoruada y revestimientos - varios modelos - (ver Renault)	162.702	N 103 091 01

Ø M6 x 12
arandela Ø 18



161.798

Ø M6 x 19



161.486

Ø M6 x 27



162.397

Ø 2,4 x 5



162.362

Ø 3,2 x 6

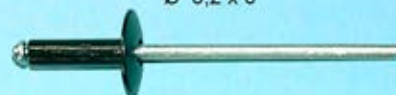

161.650

Ø 3,2 x 9

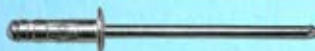

161.865

Ø 3,2 x 13



161.866

Ø 4 x 14

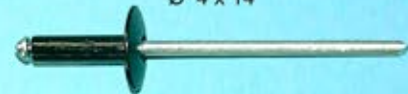

161.653

Ø 4,8 x 15



161.867

Ø 6,4 x 10



161.844

U.E.	DESCRIPCION	261	Ref. Adaptable
10	Tornillo Ø 6 x 19, fijac. parachoques trasero VW Golf IV (ver PSA)	161.486	6N0 807 199
100	Remache Ø 3,2 x 6, varios usos V.A.G.	161.650	N 906 349 01
100	Remache Ø 4 x 14, paso rueda y spoiler VW Golf	161.653	
50	Tornillo Ø 6 x 12 (aro Ø 18), fijac. aleta delantera Audi A6 '00, VW Golf V, Passat '11, Polo '10, UP	161.798	N10009110
25	Remache Ø 6,4 x 10, fijac. elevelunas Audi TT '10->'14, Skoda Fabia '00->'07, Octavia '04->'13, VW Caddy '16->, Jetta '06->, Transporter '09->	161.844	N 910 788 01
50	Remache Ø 3,2 x 9, fijac. moldura parabrisas Audi A4 '13->, A5 '08->, Q3, Q5, TT '15->, fijac. junta moldura techo A6, A7, Q3, Q5	161.865	N 912 014 01
50	Remache Ø 3,2 x 13, fijac. moldura parabrisas Audi A4 Cabrio '03->'09, RS4 Cabrio '07->'09, R8	161.866	N 016 217 2
25	Remache Ø 4,8 x 15, fijac. soporte parachoques A4 '13->, A5, A6 '11->, A7, Q5 '13->'17, fijac. altavoces Audi A3 '03->'08, Q7 '16->, Seat Alhambra '11->, Arosa, Ateca, Cordoba '03->'09, Ibiza '02->'12 y '12->, León '02->'06, Mii, Toledo '13->, Skoda Citigo, Fabia '00->'15 y '15->, Karoq, Kodiaq, Octavia '04->'13, Roomster, Superb, Yeti, VW Amarok, Beetle, Caddy '04->, Crafter '17->, Golf 4, 5 y 6, Passat '05 y '11->, Polo '02->'09 y '09->'14, Scirocco, Sharan '11->, Tiguan, Touareg, Touran '03->'15, Transporter T5 '03->'09 y '09->, Up!	161.867	N 907 657 01
10	Tornillo fijac. parachoques delantero y trasero Seat Ibiza'93, Córdoba, VW Golf IV	162.397	6N0 807 199 N 907 407 01
50	Remache Ø 2,4 x 5, varias aplicaciones (ver Fiat, Ford, Opel, PSA, Renault)	162.362	



161.765



161.482



161.836



161.819



161.791



161.830



161.768

Tornillo Ø 4,2



161.459

Tornillo Ø 4,8



161.808

Tornillo Ø 6,3



161.460

Tornillo Ø 6,3



161.755



161.818



161.817

U.E.	DESCRIPCION	261	Ref. Adaptable
25	Tuerca fijac. moldura cristal puerta Audi A3, A4, Skoda Superb '02, VW Caddy '04, Golf V, Lupo, Passat '00, Polo '01, Touran (ver Fiat)	161.459	N 90257703
25	Tuerca fijac. guardabarros VW Golf, Polo '95 (monta con 162.556)	161.460	N 012 062 2
25	Fijac. revestimientos portón trasero Audi A2, A3, Seat Ibiza, Skoda Fabia, VW Golf IV, Polo '02->	161.482	4B0 867 276 A 4A0 867 276
50	Fijac. aleta delantera VW Golf IV	161.755	N 103 055 02
25	Fijac. moldura portón maletero VW Bora, Golf IV, V y VI, Passat '05, Tiguan, Touran	161.765	1J6 867 276
25	Fijac. revestimientos maletero VW Bora, Golf IV, Touran	161.768	1J9 867 981
25	Fijac. talonera puerta Audi A1, A3 '03, Seat Altea, Ibiza '02, Cordoba '03, Leon, Toledo, VW Golf V, otros usos A2, A4, A6, A7, Alhambra, Exeo, Mii, Passat, Sharan, Tiguan, UP	161.791	4A0 867 276 A
50	Fijac. insonorizante motor Audi A2, A3 '97->'03, Seat Arosa, Leon '99->'05, Ibiza/Cordoba '99->'08, Toledo '99, VW Golf IV, Lupo, Polo '02->'09	161.808	N 103 271 01
25	Fijac. tapa motor Audi A3 '97->'03, A4 ->'08, A6 ->'05, Seat Arosa, Exeo, Ibiza/Cordoba '99->'02, Toledo/Leon '99, Octavia, VW Golf IV, Passat ->'05, fij. parachoques Audi Q7, Fabia '07, Touareg	161.817	N 908 475 01
25	Fijac. parachoques Audi A1, A3 '08, Q7, Seat Exeo, VW Golf V y VI, Passat '05->'11, Polo '02->'09, Tiguan, Touran	161.818	6Q0 807 180
25	Fijac. tapizados interiores Audi A1, A3, A4, A5, A6, A7, Q2, Q3, Q5, TT, Seat Altea, Arona, Ateca, Exeo, Ibiza '08->, Leon '13->, Skoda Karoq, VW Golf 7 '13->, Passat '05 y '11->, Tiguan '16->	161.819	8L4 867 276
25	Fijac. tapizados interiores Audi A1, A2, A3, A4, A5, A6, Q3, Q5, Seat Alhambra '11, Altea, Ibiza '08->, Leon '05->, Mii, Toledo '05 y '13->, Skoda Citigo, Fabia '07, Octavia '04, Rapid, Superb, Yeti, VW Caddy '09, Golf VII, Passat '05 y '11->, Polo '02 y '09->, Scirocco, Sharan '11, Touran, Up	161.830	4A0 867 276 B
25	Fijac. tapizados interiores maletero Seat Ibiza '02 y '08, León/Toledo '99->'05, Skoda Octavia '05->, Yeti, VW Golf IV, Passat '97, '05 y '11->, Polo '02->'09, Touran '03 y '10->, Touareg '03->'10	161.836	3B9 867 289



161.429



162.711



162.712



162.904

cabeza Ø 13
agujero Ø 7
tornillo Ø 5



163.544



161.838



161.735

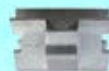

161.770



163.071



161.766

U.E.	DESCRIPCION	261	Ref. Adaptable
50	Tuerca fijac. altavoces V.A.G.	161.429	N 0386021
50	Fijac. revestimientos puerta (apoyabrazos) Seat Altea, Ibiza '02, León '99 y '05, Toledo '99 y '05, VW Golf IV y V, Passat '97, Polo '02	161.735	N 907 468 01
25	Fijac. moldura estribera, panel puerta y otros usos interiores Audi A3 '04->, A4 '01->, A5, A6 '05->, Q5, Q7, TT, Seat Alhambra '03->, Altea, Ibiza / Cordoba '02, León '05, Toledo '05, Skoda Fabia, Octavia '04, Superb '08, VW Golf IV '03->, V y VI, EOS, Jetta, New Beetle Cabrio, Polo '02->, Sharan '01->, Tiguan, Transporter '03->	161.766	1J0 858 137 B 1J0 858 137 A
50	Fijac. revestimientos puerta Seat Ibiza '09, León '05	161.770	1P0 864 247
25	Fijac. revestimientos maletero Skoda Octavia '97->'11, fijac. tapizados interiores VW Jetta '11->	161.838	1U0 868 731 A
25	Tuerca c/aro móvil (Ø 6), varios usos (ver Dacia, Ford, Opel, PSA, Renault)	162.711	
25	Tuerca c/aro móvil (Ø 8), varios usos (ver Ford, Opel, PSA, Renault)	162.712	
10	Fijac. rejilla a parachoques delantero VW Polo '95	162.904	N 902 184 01
25	Fijac. manecilla respaldo VW Golf IV, Polo, Passat	163.071	311 881 247
10	Boca fijac. tapizados Seat Alhambra, Skoda Fabia. Octavia, VW Golf III, Polo, Sharan, Touran	163.544	N 904 792 01



161.427



161.418



161.484



161.736



161.741



161.744



161.839



161.498



161.491



161.840



161.737



161.859



161.738

U.E.	DESCRIPCION	261	Ref. Adaptable
50	Clip fijac. pasoruada Golf y varios usos Ibiza, Toledo	161.418	N 901 708 01
50	Clip fijac. varios usos VAG (ver BMW, Opel, Renault)	161.427	N 902 689 01
50	Clip fijac. tapizados portón trasero Polo 2002, fijac. parrilla radiador Transporter IV, fijac. otros usos VAG	161.484	N 015 429 1 N 015 429 2
50	Clip fijac. varios usos VAG	161.491	N 015 458 1
50	Clip fijac. varios usos VAG - varios - (ver BMW, Mercedes)	161.498	N 015 445 2
50	Clip fijac. pasoruada Seat León '99, Toledo '99, fijac. parachoques Seat Toledo '91->'99, fijac. otros usos VAG	161.736	N 015 429 1 N 015 422 2 N 015 422 7
50	Clip fijac. varios usos Audi 80, A3, A6, Seat Alhambra, Arosa, Córdoba, Ibiza, Inca, León, Toledo, Skoda Fabia, Octavia, Superb, VW Caddy, Golf, LT, Lupo, Passat, Polo, Sharan, Transporter	161.737	N 015 439 1
50	Clip fijac. pasoruada Audi A2, fijac. otros usos Audi A3, A4, A6, VW LT, Passat	161.738	N 015 437 3
50	Clip fijac. parachoques Seat Altea, Ibiza/Córdoba '99 y '02->, León '05->, VW Touareg, fijac. pasoruada Audi A3 '03, Seat Altea, Leon '05, fijac. moldura estribera puerta Seat Altea, fijac. bajos carroceria Audi Q5, Seat Altea, Leon '05	161.741	N 908 251 01
50	Clip fijac. varios usos VAG	161.744	N 906 987 03 N 906 987 01
50	Clip fij. pasoruada, parachoque, bajos carroceria y otros usos Audi A3 '03->, A6 '05->, A7, Q5, Q7, Skoda Fabia, Rapid, Roomster, Seat Alhambra, Exeo, Toledo '13, VW Sharan, Touareg	161.839	N 900 942 01
25	Clip fijac. parachoque Audi Q3, Q5, Q7, fijac. bajos carroceria Audi A4 '08->, A5, A6 '11->, A7, Seat Ibiza '08->, fijac. pasoruada Skoda Octavia '97->'11,	161.840	N 101 941 01
25	Clip fijac. bajos carroceria y otros usos Audi A3 '08, A4 '08, A5, A6 '13, A7, Q5, Seat Alhambra '11, León '06, VW Golf 6 '09->, Sharan '11, Touareg	161.859	N 906 106 02



162.442



161.497



161.465



161.461



161.782



161.821



163.361



164.167



164.475

U.E.	DESCRIPCION	261	Ref. Adaptable
25	Fijac. protectores cárter, protectores térmicos V.A.G. (ver Ford)	161.461	N 903 350 04
50	Clip fijac. frontal Golf III	161.465	N 015 432 2
50	Clip fijac. guardabarros delantero VW Golf, Polo'95	161.497	N 901 686 02
25	Fijac. protectores motor/cárter V.A.G.	161.782	N 907 965 02 N 903 350 05
25	Fijac. protectores motor/cárter V.A.G.	161.821	N 907 965 01
50	Clip fijac. pasoruada VAG (ver Fiat, PSA, Renault)	162.442	
50	Junta fijac. protector motor/cárter - varios modelos -, fijac. pasoruada Audi 80/100/A6/A8	163.361	4A0 805 137 A
50	Junta fijac. prachoque A1, A3 '08, Q5, Q7, Skoda Fabia '07, VW Golf V, Passat '05, Polo, Tiguan, Touareg '03, Touran, Transporter T5	164.167	6N0 129 355
1	Conector retrovisores Audi Q7, VW Transporter T5	164.475	

161.707

161.708

161.712

161.713

161.780

161.709

161.710

161.711

161.772

161.792

U.E.	DESCRIPCION	261	Ref. Adaptable
10	Tornillo fijac. protector motor/cárter - varios modelos -	161.707	8D0 805 121 B
10	Tornillo fijac. protector motor/cárter - varios modelos -	161.708	8D0 805 121
10	Tuerca fijac. protector motor/cárter - varios modelos -	161.709	8D0 805 960
10	Tuerca fijac. protector motor/cárter Audi 80, 100, Cabriolet	161.710	4A0 805 960
10	Tuerca fijac. protector motor/cárter Audi A4, fijac. parachoques Audi A4, A6	161.711	8E0 805 960
10	Tornillo fijac. protector motor/cárter Audi 80, A8, Cabriolet	161.712	4A0 805 121 B
10	Tornillo fijac. parachoques Audi A4, A6	161.713	8E0 805 121 A
10	Tuerca fijac. protector motor/cárter Audi A4 '08->, A5, Q5 (ver BMW, Mini)	161.772	8K0 805 922 A
10	Tornillo fijac. protector motor/cárter Audi A4 '08->, A5, Q5	161.780	8K0 805 121
10	Tuerca fijac. protector motor/cárter Audi A6 '05->	161.792	4F0 805 163



U.E.	DESCRIPCION	261	Ref. Adaptable
25	Tapón protector motor/cárter - varios -	163.227	4A0 805 121 A
25	Tuerca protector motor/cárter - varios -	163.228	4A0 805 163
25	Tuerca fijac. bajos Audi A3, VW Polo ->'02, Golf IV, Golf V	163.229	N 105 791 01
25	Tapón fijac. protector motor/cárter - varios modelos -	163.319	4A0 805 121 C
25	Tapón fijac. protector motor/cárter - varios modelos - VW Polo, Golf III, Touran, Sharan	163.540	4F0 805 121
25	Tapón fijac. parachoques Audi A1, A3, Q5, Q7, VW Golf V, Passat '05->, Polo '02, Tiguan, Touran, Transporter	164.070	6Q0 807 643
25	Tapón protector motor/cárter Audi A4 '94->'08, A6 '95->'05, VW Passa '00->'05	164.083	N 906 420 01
25	Tapón fijac. parachoques Touareg '03->'10	164.166	N 907 234 01
25	Fijac. tapiz. interiores Seat Alhambra ->'10, Skoda Fabia '00->, Felicia, Octavia '97->, Roomster, VW Golf IV, Polo '02->'09, Sharan ->'10	164.608	3D0864851B41
25	Fijac. tapiz. interiores Seat León '99->'04, Toledo '99->'04, VW Golf IV '98->'04, Passat '97->'05, Polo '00->'05, Touran '06->'15	164.641	3D0864812AB41

164.317 *- Izdo.

164.319 *- Izdo.

164.316 *- Dcho.

164.318 *- Dcho.

164.767 *- Izdo.

164.766 *- Dcho.

* (imagen 1/2 tamaño real)

U.E.	DESCRIPCION	261	Ref. Adaptable
1	Soporte parachoques delantero derecho Audi A3 '03->'08	164.316	8P0 807 184 A
1	Soporte parachoques delantero izquierdo Audi A3 '03->'08	164.317	8P0 807 183 A
1	Soporte parachoques delantero derecho Audi A3 '08->'13	164.318	8P0 807 184 B
1	Soporte parachoques delantero izquierdo Audi A3 '08->'13	164.319	8P0 807 183 B
1	Soporte parachoques delantero derecho Audi A3 '13->'16	164.766	8V3 807 184 A
1	Soporte parachoques delantero izquierdo Audi A3 '13->'16	164.767	8V3 807 183 A

261/



164.321 *- Izdo.



164.320 *- Dcho.



164.323 *- Izdo.



164.322 *- Dcho.



164.715 *- Izdo.



164.714 *- Dcho.



164.331 *- Izdo.



164.330 *- Dcho.

* (imagen 1/2 tamaño real)

U.E.	DESCRIPCION	261	Ref. Adaptable
1	Soporte parachoques delantero derecho Audi A4 '05->'08	164.320	8E0 807 284 E
1	Soporte parachoques delantero izquierdo Audi A4 '05->'08	164.321	8E0 807 283 E
1	Soporte parachoques delantero derecho Audi A4 '08->'12	164.322	8K0 807 284
1	Soporte parachoques delantero izquierdo Audi A4 '08->'12	164.323	8K0 807 283
1	Soporte parachoques delantero derecho VW Polo '05->'09	164.330	6Q0 807 184 A
1	Soporte parachoques delantero izquierdo VW Polo '05->'09	164.331	6Q0 807 183 A
1	Soporte parachoques delantero derecho Audi A4 '12->'15	164.714	8K0 807 284 H
1	Soporte parachoques delantero izquierdo Audi A4 '12->'15	164.715	8K0 807 283 H

164.325 *- Izdo.

164.324 *- Dcho.

164.327 *- Izdo.

164.326 *- Dcho.

164.329 *- Izdo.

164.328 *- Dcho.

U.E.	DESCRIPCION	261	Ref. Adaptable
1	Soporte parachoques delantero derecho VW Golf V '04->'09, Jetta '05->'11	164.324	1K0 807 184
1	Soporte parachoques delantero izquierdo VW Golf V '04->'09, Jetta '05->'11	164.325	1K0 807 183
1	Soporte parachoques delantero derecho VW Passat '05->'10	164.326	3C0 807 184
1	Soporte parachoques delantero izquierdo VW Passat '05->'10	164.327	3C0 807 183
1	Soporte parachoques delantero derecho VW Passat '11->'15	164.328	3AA 807 184
1	Soporte parachoques delantero izquierdo VW Passat '11->'15	164.329	3AA 807 183

261/

162.295*

162.969*

164.268

162.403

162.317

163.001 *- Izdo.

163.000 *- Dcho.

163.739 *- Izdo.

163.738 *- Dcho.

* (imagen 1/2 tamaño real)

U.E.	DESCRIPCION	261	Ref. Adaptable
5	Soporte parachoques delantero VW Golf '89	162.295	165 807 193 B
5	Tope parachoques VW Golf, Polo	162.317	171 807 267
10	Tope lateral parachoques VW Golf (ver Fiat)	162.403	191 807 193
5	Soporte lateral parachoques Seat Alhambra, Ibiza '93-'97, VW Golf II y III, Sharan, Passat -> '97	162.969	7M0 807 181 A
1	Soporte parachoques delantero derecho Seat Córdoba '97, Ibiza '97	163.000	6K5 807 184
1	Soporte parachoques delantero izquierdo Seat Córdoba '97, Ibiza '97	163.001	6K5 807 183
10	Refuerzo aleta delantera derecha Seat Ibiza '09->	163.738	6J0 821 120 A 6J0 821 120
10	Refuerzo aleta delantera izquierda Seat Ibiza '09->	163.739	6J0 821 119
25	Fijac. parachoque trasero Audi Q5	164.268	8R0 853 575



163.242

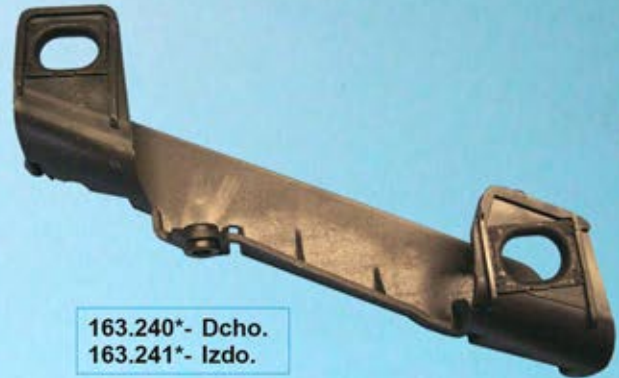

163.240* - Dcho.
163.241* - Izdo.

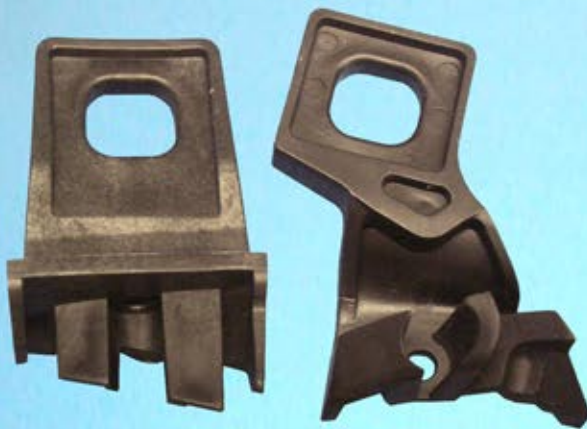

163.236 - Dcho.
163.237 - Izdo.



163.238* - Dcho.
163.239* - Izdo.



164.702* - Dcho.
164.703* - Izdo.



163.004* - Dcho.
163.005* - Izdo.

* (imagen 1/2 tamaño real)

U.E.	DESCRIPCION	261	Ref. Adaptable
1	Kit reparación faro derecho VW Golf IV	163.004	1J0 998 226
1	Kit reparación faro izquierdo VW Golf IV	163.005	1J0 998 225
1	Kit reparación faro derecho VW Polo '02->	163.236	6Q0 998 226
1	Kit reparación faro izquierdo VW Polo '02->	163.237	6Q0 998 225
1	Kit reparación faro derecho VW Lupo '99->'06	163.238	6X0 998 226
1	Kit reparación faro izquierdo VW Lupo '99->'06	163.239	6X0 998 225
1	Kit reparación faro derecho Audi A4 '01->'05	163.240	8E0 998 122
1	Kit reparación faro izquierdo Audi A4 '01->'05	163.241	8E0 998 121
1	Kit reparación faro derecho e izquierdo Audi A3 '97->'03	163.242	8L0 998 121
1	Kit reparación faro derecho VW Polo '10->	164.702	6R0 998 226
1	Kit reparación faro izquierdo VW Polo '10->	164.703	6R0 998 227



178.098



173.196



173.197



173.080



162.292



162.293



162.294



162.720



Tornillo Ø 5

163.428

U.E.	DESCRIPCION	261	Ref. Adaptable
5	Regulador faro VW Golf '90	162.292	191 941 133
5	Regulador faro VW Golf '90	162.293	191 941 141
50	Fijac. regulador faro VW Golf '90 (ver BMW)	162.294	191 941 142
10	Fijac. indicadores y luz de freno VW TT (ver Fiat)	162.720	8N0 951 257
25	Fijac. faro antiniebla A2, A3 '01->'08, A4 '99->'08, A6 '98->'05, A8, fijac. parachoques A6 '98->'05 (ver Renault)	163.428	8D0 807 192
1	Regulador eléctrico faro A3 '03->'08, A4 '05, TT, Seat Alhambra, Skoda Octavia '00, VW Caddy '04, Golf V, LT '04->, New Beetle, Passat '09->, Polo '02->'05, Sharan, Touran, Transporter '03-> (ver Fiat, Ford, Smart)	173.080	1J0 941 295 A
1	Regulador eléctrico faro Audi A2, A4 '99->'04, Q7, Seat Arosa, Ibiza/Cordoba '99->'02 y '02->'08, Leon '99->'05, Toledo '99->'04, VW Golf IV y V, Lupo, Polo '99->'05	173.196	1J0 941 295 B
1	Regulador eléctrico faro Audi A3 '08, VW Crafter '06, Golf V y VI, Jetta, Passat '05, Polo '05, Touareg (ver Opel)	173.197	1K6 941 295
1	Regulador eléctrico faro Audi Q5, Seat Altea, Exeo, Ibiza '09->, Leon '05, Toledo '05, Polo '05-> (ver Opel)	178.098	5P0 941 295

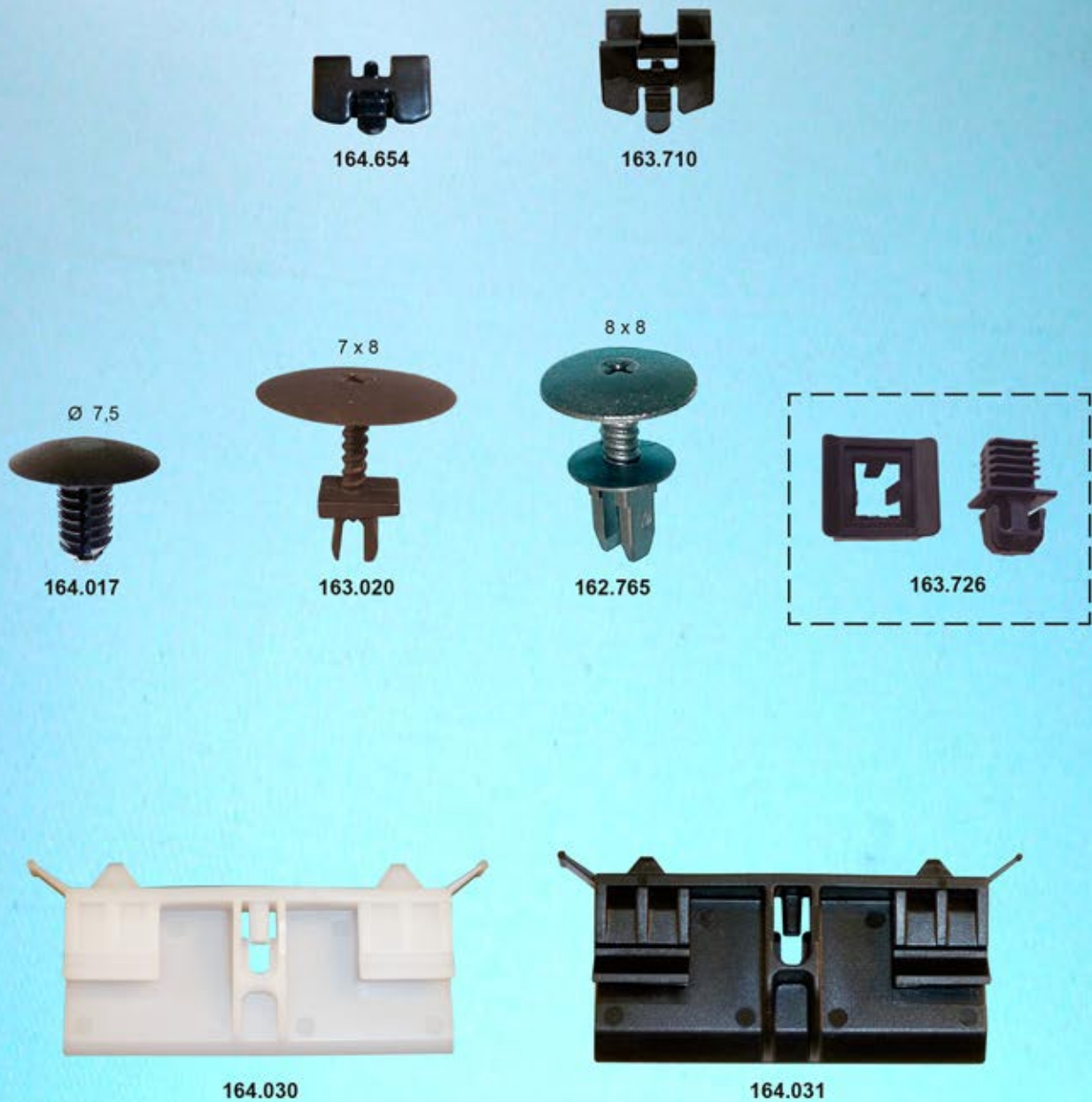

U.E.	DESCRIPCION	261	Ref. Adaptable
50	Fijac. rejilla parabrisas "torpedo" VW Golf III, Skoda Octavia '97-> (Eurocode 8541ASCHB)	162.765	1H0 819 055 C
25	Fijac. rejilla parabrisas "torpedo" Seat Ibiza/Cordoba '93->'99, Inca '96->'04, VW Caddy'96->'03	163.020	6K0819285 B41
25	Fijac. moldura parabrisas VW Touran '03->'15	163.710	1T0 853 910 A
25	Fijac. rejilla parabrisas "torpedo" Alhambra '96->'09, Sharan '96->'05 (Eurocode 3550ASCVB)	163.726	7M3 853 585
25	Fijac. rejilla parabrisas "torpedo" Skoda Fabia '00->'07 (Eurocode 7808ASCHB)	164.017	N 909 113 01
10	Fijac. moldura parabrisas Skoda Yeti '10-> (Eurocode 7813ASCRC6B)	164.030	5L0 853 577
10	Fijac. moldura parabrisas Skoda Yeti '10-> (Eurocode 7813ASCRC5)	164.031	5L0 853 573
10	Fijac. moldura parabrisas Audi Q7 '16->, Seat Alhambra '10, Ateca '16, VW Golf VII, Passat '15, Sharan '10, Tiguan '16, Touareg '10, Touran '16	164.654	7P6 853 910 A



162.689



162.690



164.843



163.709



162.990



162.991



163.637



163.850



162.787



163.545



162.370



162.759



162.760

U.E.	DESCRIPCION	261	Ref. Adaptable
50	Fijac. moldura lateral parabrisas Skoda Fabia '07->, Roomster '06-> (Eurocode 7811ASCMS) (ver PSA)	162.370	5J0 853 573
100	Fij. moldura techo Seat Ibiza/Cordoba '93->'99, Inca '96->'01, Toledo '92->'99, VW Caddy '96->'03, Golf '84->'92, Passat '88->'97, Polo Classic '96->'00 (Eurocode 7603ASCS y 7603ASCH)	162.689	191 853 733 A
100	Fijac. moldura techo VW Golf III '92->'99, Vento (Eurocode 8541ASCH)	162.690	1H0 853 733 B
25	Fijac. rejilla aire a capó VW Golf III '92-'99, Inca (monta con 162.760) (Eurocode 8541ASCBH1)	162.759	1H0 819 055 B
25	Boca fijac. rejilla aire a capó VW Golf III '92->'99, Inca (monta con 162.759)	162.760	1H0 819 946 A
25	Fijac. moldura parabrisas Seat Altea, Toledo '05	162.787	191 853 585 A
10	Fijac. moldura lateral parabrisas Seat Toledo '99->'05, León '99->'05 (Eurocode 7608ASCSS)	162.990	1M0 854 541 A
10	Fijac. moldura lateral parabrisas Seat Toledo '99->'05, León '99->'05 (Eurocode 7608ASCSS1B)	162.991	1M0 854 719 A
25	Fijac. rejilla parabrisas "torpedo" Seat Altea, Leon '05, Toledo '05-> (Eurocode 7610LSCHRQ)	163.545	6L6 853 575 A 6L6 853 575
50	Fijac. moldura lateral parabrisas Seat León '05->'12 (Eurocode 7613ASCHS)	163.637	1P0 854 719 B 1P0 854 719 C
10	Fijac. moldura lateral parabrisas VW Phaeton, Touareg	163.709	3D5 853 707 B
50	Fijac. moldura lateral parabrisas Seat Ibiza '09-> (Eurocode 7614ASCHS)	163.850	6J0 854 719 C
10	Fijac. moldura lateral parabrisas Audi A4 Cabrio '03->'09 (Eurocode 8574ASCTS4B)	164.843	8H0 853 478

181.425

181.426

181.427

181.441

181.439

181.442

181.429

181.438

181.440

181.428

U.E.	DESCRIPCION	261	Ref. Adaptable
10	Leva cerradura puerta (largo: 50,1 mm.) Seat Ibiza/Cordoba '93->'99	181.425	6K3 837 223
10	Leva cerradura puerta (largo: 56,7 mm.) VW Golf/Vento III '92->'99, Polo Derby '95->'00	181.426	1H0 837 223 B 6K4 837 223 B
10	Leva cerradura puerta (largo: 71,3 mm.) Seat Ibiza/Cordoba '93->'99, Inca '96->'03	181.427	6K4 837 223
10	Leva cerradura puerta codificada (largo: 67,6 mm.) Seat Ibiza / Cordoba '97->'02 (5 puertas), Inca '96->'03, VW Caddy '96->'03, Polo Classic '97->'02	181.428	6K4 837 223 A
10	Leva cerradura puerta codificada (largo 47 mm.) Seat Ibiza/Cordoba '97->'02 (3 puertas)	181.429	6K3 837 223 A
10	Leva cerradura puerta codificada (largo 52 mm.) Seat Arosa '98->, León '99->'04, Toledo '99->'05, VW Lupo '99->'03, Passat '97->'05	181.438	
10	Leva cerradura puerta codificada (largo 39 mm.) VW Caddy '04->'11, Fox, Transporter T5 '03->'09	181.439	
10	Leva cerradura puerta codificada (largo 57,5 mm.) VW Polo '95->'02	181.440	6N0 837 223 A
10	Leva cerradura puerta codificada (largo 42,5 mm.) Seat Alhambra, VW Sharan '96->'09	181.441	7M0 837 223 A
10	Leva cerradura puerta codificada (largo 44 mm.) VW Golf IV '98->'04, Bora '99, Fox	181.442	

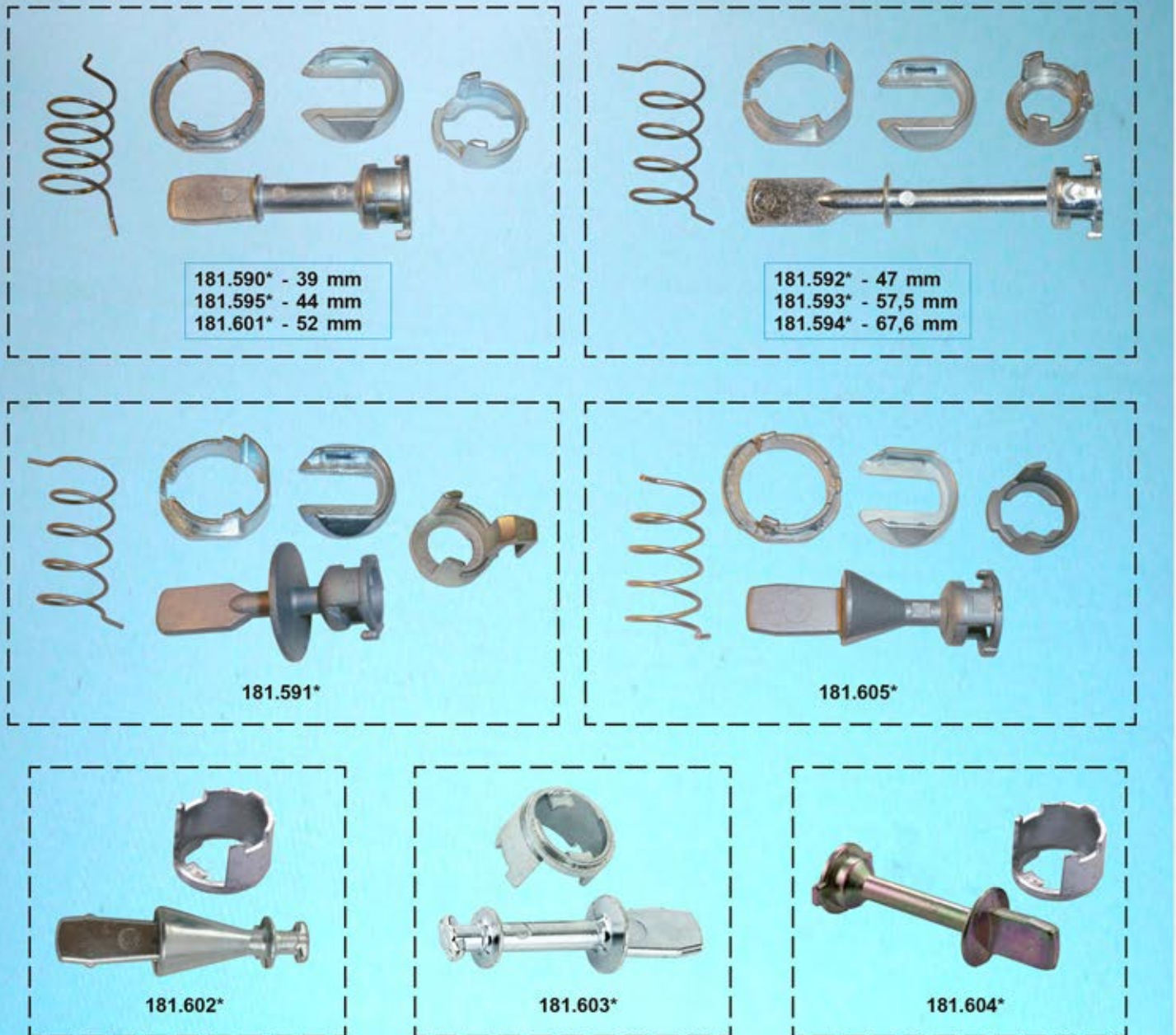

* (imagen NO a tamaño real)

U.E.	DESCRIPCION	261	Ref. Adaptable
1	Kit cerradura puerta codificada (largo 39 mm) VW Caddy '04->'11, Fox, Transporter T5 '03->'09	181.590	7H0 898 167
1	Kit cerradura puerta codificada (largo 42,5 mm) Seat Alhambra, VW Sharan '96->'09	181.591	7M0 898 083 A
1	Kit cerradura puerta codificada (largo 47,0 mm) Seat Ibiza/Cordoba '97->'02 (3 puertas)	181.592	
1	Kit cerradura puerta codificada (largo 57,5 mm) VW Polo '95->'02	181.593	
1	Kit cerradura puerta codificada (largo 67,6 mm) Seat Ibiza / Cordoba '97->'02 (5 puertas), Inca '96->'03, VW Caddy '96->'03, Polo Classic '97->'02	181.594	
1	Kit cerradura puerta codificada (largo 44,0 mm) VW Golf IV '98->'04, Bora '99, Fox	181.595	1U0 837 167 E 1U0 837 167 C
1	Kit cerradura puerta codificada (largo 52 mm) Seat Arosa '98->, León '99->'04, Toledo '99->'05, VW Lupo '99->'03, Passat '97->'05	181.601	3B0 837 167 G
1	Kit cerradura puerta codificada VW Passat (3C2) '05->'10	181.602	
1	Kit cerradura puerta codificada VW Golf 6 '08->'13, Jetta '05->'11	181.603	
1	Kit cerradura puerta codificada VW Transporter T6 '15->	181.604	
1	Kit cerradura puerta codificada (largo 44,0 mm) Skoda Fabia '00->'04, Octavia '97->'11	181.605	1U0 898 001 + 1U0 898 002 + 1U0 898 006



U.E.	DESCRIPCION	261	Ref. Adaptable
10	Tope goma Seat / VW	162.329	
50	Fijac. guarnecidos contorno capó motor Seat Alhambra '97->'09, Toledo '92->'99, VW Golf '84->'92, Lupo, Polo '02->'05, Sharan '96->'09, LT, Transporter '96->'04	162.504	251 823 717
10	Fijac. tubo aire cierre centralizado VAG	162.818	
50	Fijac. guarnecidos contorno capó motor Audi A1, A4 '08, A5, A6 '11, A7, Q5, Q7, Seat Alhambra '96, Arosa, Skoda Octavia '97, VW Caddy '04 y '11, Golf III, IV, V y VI, Lupo, Polo '95, Sharan, Touran	162.920	1H0 823 717
10	Fijac. parrilla delantera VW Lupo	163.049	6X0 853 575
50	Fijac. guarnecido contorno capó motor VW Polo	163.050	6K0 823 717
25	Fijac. varilla puerta Audi 100, A3 ->'03, A4 ->'01, A6 ->'97, Seat Arosa, Ibiza/Córdoba '96->'99, León/Toledo '99->'05, VW Caddy '04, Golf ->'05, Lupo, Passat ->'97, Polo ->'02, Transporter ->'03	163.067	171 837 199
25	Fijac. embellecedor parrilla radiador Seat Ibiza/Córdoba'95, Inca '98	163.187	6K0 853 129
50	Fijac. junta capó Seat Leon '13->	164.077	6L0 839 720
25	Fijac. rejilla radiador VW Transporter T4 '91->'03	164.259	701 805 163
5	Tope (goma) capó Seat Alhambra '97, Arosa '97, VW Golf III y IV, Lupo '99, Polo '95, Sharan '96	164.379	1H0 823 499



U.E.	DESCRIPCION	261	Ref. Adaptable
50	Botón + boca fijac. revestimientos contorno puerta VW Golf III (ver Ford, Opel)	162.844	1H0 837 719
50	Fijac. juntas estanqueidad puertas Audi 80, 100, A3, A4, A6, A8, New Beetle Cabrio, fijac. tapizados interiores León '99->'05, Toledo '99->'05	163.206	8L3 837 199 B
25	Boquilla moldura vierteaguas Audi A4 '01->'08, A6 '05->	163.232	8E5 853 213
50	Fijac. juntas estanqueidad puertas Seat Ibiza/Córdoba '02->	163.346	6L0 839 720 A
25	Fijac. juntas goma puerta Audi A4 '01->, A6 '05->, R8	163.396	8E0 837 485 C
25	Fijac. junta goma puerta Skoda Superb '02->'08, VW Bora, Golf IV, Passat '97->'05	163.687	3B0 839 723
25	Fijac. juntas estanqueidad puertas VW Golf V y VI, Jetta '09->	163.824	1K0 837 199 B
50	Fijac. junta goma puerta Seat Ibiza '02->, León '99->'05, Toledo '99->'05	163.834	1M0 837 720 E
50	Fijac. junta goma puerta Seat Cordoba '03->, Ibiza '02->, León '99->'05, Toledo '99->'05, y fij. junta capó Seat León '13	163.835	1M0 837 720 F
50	Fijac. junta goma puerta Seat León '13, Skoda Octavia '04, Roomster, VW Golf VI y VII, Passat '11, Scirocco '08, y fij. guia ventanilla VW Passat '11	163.875	1Z0 837 732 A
50	Fijac. junta goma puerta Seat Exeo	164.028	8E0 837 485 D
50	Fijac. junta goma puerta Skoda Octavia '04->, VW Scirocco '08->	164.037	1Z0 837 732 1K8 837 732
50	Fijac. junta goma puerta Seat Ibiza '08->	164.077	6L0 839 720
25	Fijac. junta goma puerta VW Transporter T5 '03->	164.131	7H0 837 485
50	Fijac. junta goma puerta Audi A6 '11->, A8 '10->	164.165	4H0 837 732
25	Fijac. junta goma puerta Skoda Fabia '00 y '07->, Octavia '00->'13	164.169	6Y0 823 717
50	Fijac. junta goma puerta Seat Toledo '13->, Skoda Octavia '13->, Rapid '13->, Superb '14->	164.645	5E0 837 732
50	Fijac. junta cristal puerta Seat Alhambra '10, Cordoba '02->'09, Ibiza '02 y '08->, Exeo, Skoda Fabia '15, Octavia '13, Rapid '13, Superb '14, VW Golf 6 y 7, Passat '05->'15, Polo '02 y '09, Sharan '10, Tiguan '09, Touran '03	164.653	6E0 837 732
25	Fijac. junta goma puerta Audi A5	164.699	8T0 837 485 A



163.543



162.845



162.846



164.098



164.383



163.189



162.840



162.854



162.763



162.764

U.E.	DESCRIPCION	261	Ref. Adaptable
10	Fijac. derecha rejilla frontal VW Polo '95	162.763	6N0 853 826
10	Fijac. izquierda rejilla frontal VW Polo '95	162.764	6N0 853 825
10	Fijac. aislamiento capó motor VW Golf III	162.840	1H0 863 850
25	Fijac. insonorizantes capó VAG '92-> (largo 20 mm.)	162.845	1H5 863 849
25	Fijac. insonorizantes capó Seat Alhambra, Ibiza/Córdoba '93, Inca, Skoda Octavia '97->'00, VW Caddy, Golf III, Passat ->'97, Polo ->'02, Sharan (largo 30 mm.)	162.846	867 863 849 A
-	Sujeción radiador VW Caravelle, Transporter '91->'04	162.854	701 121 565
25	Tapón aisladores acústicos Audi A3 '97->'03, TT '99->'06, VW Bora, Golf IV, Polo '02	163.189	1J0 863 119
25	Fijac. insonorizante capó Audi A1, A3, A4w, A5, A6, A8, Q5, Q7, TT, VW Caddy '11, Passat '11-> (largo 20 mm.)	163.543	8E0 863 727 A
10	Fijac. cierre capó Audi A3 '13->, A6 '12->, A7, A8	164.098	4H0 823 188
5	Tope (goma) capó Seat Alhambra '97->'00, Arosa, VW Golf III, Passat '97->'00, Polo '95, Sharan '96	164.383	1H0 823 500 B

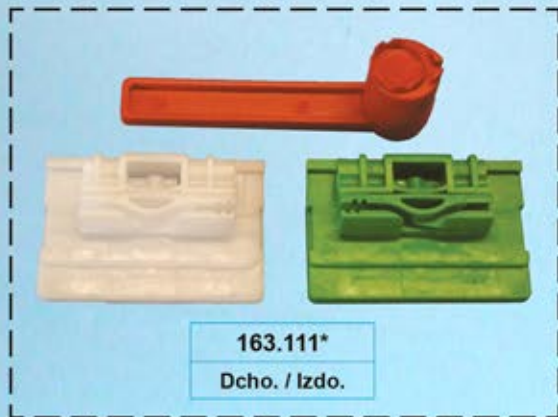

* (imagen 1/2 tamaño real)

U.E.	DESCRIPCION	261	Ref. Adaptable
1	Kit reparación elevalunas Audi A2 '00->'05	163.111	
1	Kit reparación elevalunas Audi A3 '97->'03, A6 '97->'09	163.112	
1	Kit reparación elevalunas Audi A4 '01->'08	163.113	
1	Kit reparación elevalunas izquierdo Seat biza/Córdoba '93->'01, VW Polo Classic '99->'02	163.243	
1	Kit reparación elevalunas derecho Seat biza/Córdoba '93->'01, VW Polo Classic '99->'02	163.311	
1	Soporte cristal elevalunas delantero Audi A3 '04->'13	164.000	
1	Soporte cristal elevalunas delantero Audi A3 '97->'03	164.001	



163.002*



163.031*



163.003*
Dcho. / Izdo.

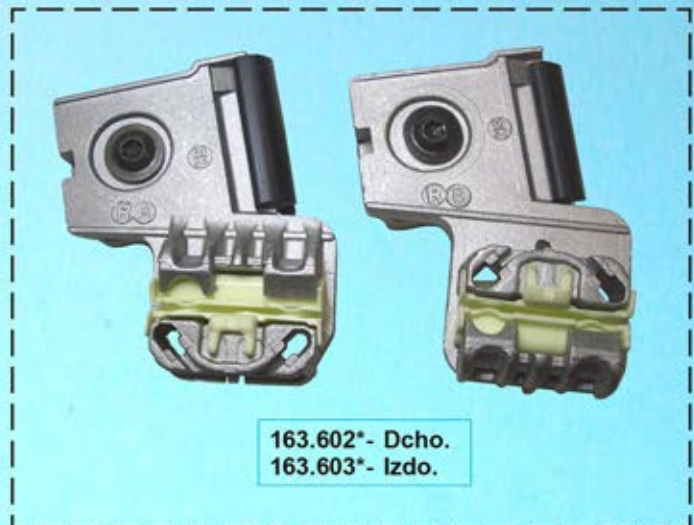

163.602*- Dcho.
163.603*- Izdo.



163.026*
Dcho. / Izdo.



163.030*
Dcho. / Izdo.

* (imagen 1/2 tamaño real)

U.E.	DESCRIPCION	261	Ref. Adaptable
1	Tensor para kit reparación elevallunas Seat Ibiza '02->'08, León/Toledo '99, VW Golf IV '98->'04	163.002	
1	Kit reparación elevallunas Seat Ibiza, Córdoba '02->'08, VW Golf IV '98->'04	163.003	
1	Kit reparación elevallunas Seat León/Toledo '99->'04, Skoda Fabia '00->'07, VW New Beetle '99->'04	163.026	
1	Kit reparación elevallunas Skoda Octavia '97->'04	163.030	
1	Tensor para kit reparación elevallunas Skoda Octavia '97->'04	163.031	
1	Kit soporte elevallunas delantero derecho VW Golf IV (aluminio) '98->'04	163.602	
1	Kit soporte elevallunas delantero izquierdo VW Golf IV (aluminio) '98->'04	163.603	



163.028*- Izdo.



163.029*- Dcho.



163.996*
Dcho. / Izdo.



163.997*
Dcho. / Izdo.



164.493*
Dcho. / Izdo.

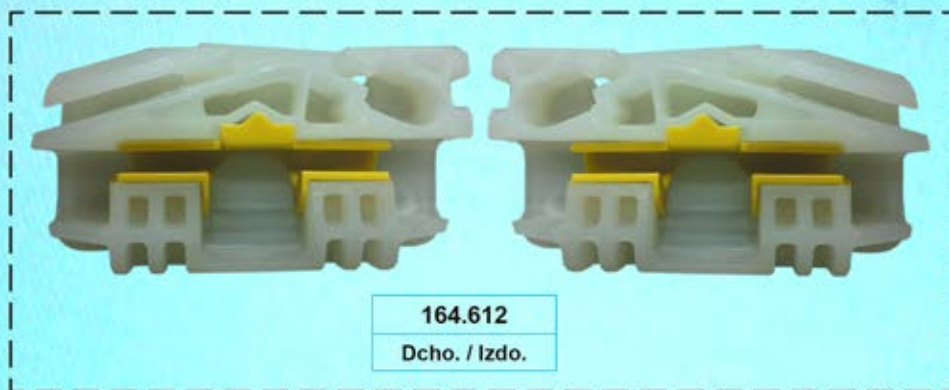

164.612
Dcho. / Izdo.

* (imagen 1/2 tamaño real)

U.E.	DESCRIPCION	261	Ref. Adaptable
1	Kit reparación elevallunas delantero izquierdo Audi A4 '94->'01, Skoda Superb, VW Passat '97->'05, y VW Polo '94->'01 (4 puertas)	163.028	
1	Kit reparación elevallunas delantero derecho Audi A4 '94->'01, Skoda Superb, VW Passat '97->'05, y VW Polo '94->'01 (4 puertas)	163.029	
1	Kit reparación elevallunas delantero Seat Alhambra '10->, VW Golf V '04->'08, Polo '09, Sharan '10	163.996	
1	Kit reparación elevallunas delantero VW Golf VI '08->'12	163.997	
1	Kit reparación elevallunas delantero VW Golf VI '08->'12	164.493	
1	Kit soporte cristal elevallunas delantero Seat Alhambra, León '05->'12, VW Sharan (ver Land Rover)	164.612	



164.373
Dcho. / Izdo.



164.510*- Dcho.
164.511*- Izdo.

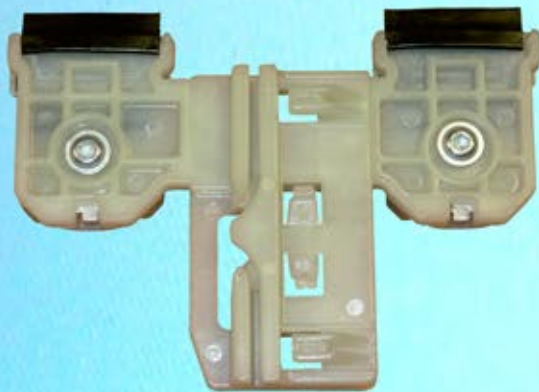

164.504*- Dcho.
164.505*- Izdo.

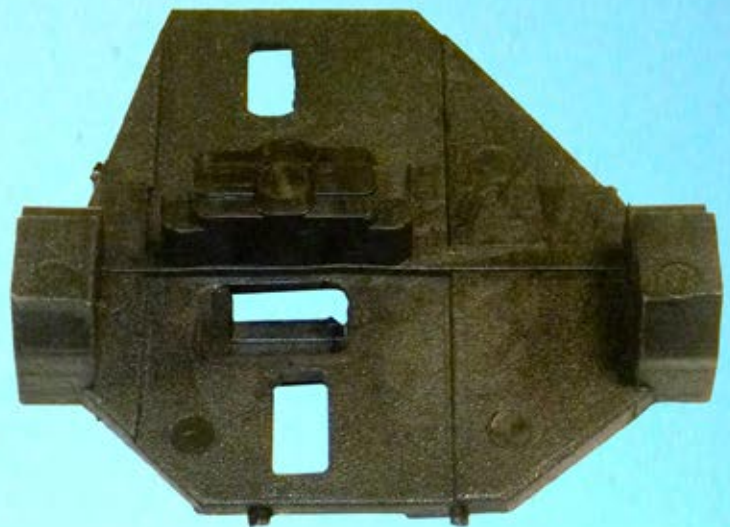

164.508- Dcho.
164.509- Izdo.

* (imagen 1/2 tamaño real)

U.E.	DESCRIPCION	261	Ref. Adaptable
1	Kit soporte cristal elevalunas VW Transporter T5 '03->	164.373	
1	Soporte elevalunas delantero derecho Skoda Fabia '07->	164.504	
1	Soporte elevalunas delantero izquierdo Skoda Fabia '07->	164.505	
1	Soporte elevalunas derecho VW Transporter T4 '96->'03->	164.508	
1	Soporte elevalunas izquierdo VW Transporter T4 '96->'03->	164.509	
1	Kit soporte elevalunas derecho VW Transporter T5 '03->	164.510	
1	Kit soporte elevalunas izquierdo VW Transporter T5 '03->	164.511	

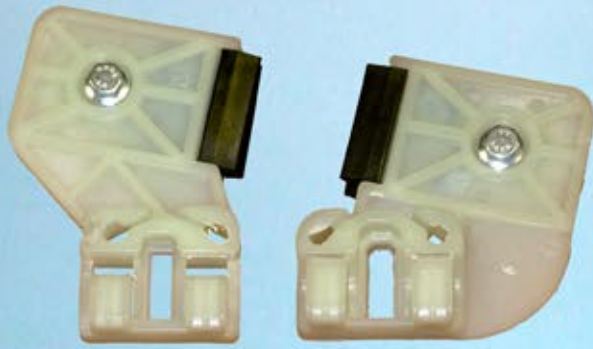

164.506*- Dcho.
164.507*- Izdo.



163.994*- Dcho.
163.995*- Izdo.



163.664*
Dcho. / Izdo.



164.372*
Dcho. / Izdo.



163.027*
Dcho. / Izdo.



164.450*
Del. / Tras.



164.451*
Dcho. / Izdo.

* (imagen 1/2 tamaño real)

U.E.	DESCRIPCION	261	Ref. Adaptable
1	Kit reparación elevallunas Seat Arosa, Ibiza/Cordoba '93->'01, VW Lupo y Polo '94->'01 (3 puertas)	163.027	
1	Kit soporte cristal elevallunas VW Touareg '02->'10	163.664	
1	Kit soporte elevallunas delantero derecho Skoda Octavia '04->	163.994	
1	Kit soporte elevallunas delantero izquierdo Skoda Octavia '04->	163.995	
1	Kit soporte cristal elevallunas VW Caddy '04->, Touran '06->'15	164.372	
1	Kit soporte cristal elevallunas Delantero y Trasero Audi Q7	164.450	
1	Kit soporte elevallunas delantero Audi A1 '10->, A4 '08->, Q3 '11->, Q5 '08->	164.451	
1	Kit soporte elevallunas delantero derecho VW Polo '02->'09	164.506	
1	Kit soporte elevallunas delantero izquierdo VW Polo '02->'09	164.507	



163.998*- Dcho.
163.999*- Izdo.



163.604*- Dcho.
163.605*- Izdo.



163.564*- Dcho.
163.565*- Izdo.

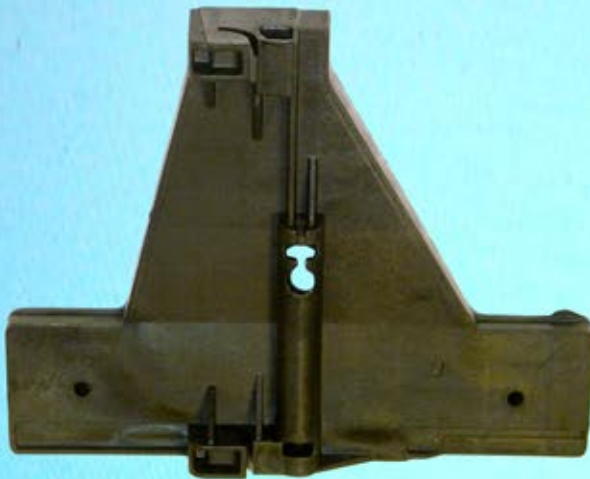

164.500*- Dcho.
164.501*- Izdo.



164.502*- Dcho.
164.503*- Izdo.

* (imagen 1/2 tamaño real)

U.E.	DESCRIPCION	261	Ref. Adaptable
1	Soporte cristal elevalunas derecho Seat Alhambra, VW Sharan '96->'10 (ver Ford)	163.564	
1	Soporte cristal elevalunas izquierdo Seat Alhambra, VW Sharan '96->'10 (ver Ford)	163.565	
1	Soporte cristal elevalunas trasero derecho VW Golf IV '98->'04, Passat '97->'05, Polo '02->'09	163.604	
1	Soporte cristal elevalunas trasero izquierdo VW Golf IV '98->'04, Passat '97->'05, Polo '02->'09	163.605	
1	Soporte cristal elevalunas trasero derecho VW Golf V y VI '04->'13, Passat '05->'10, Polo '09->'14	163.998	
1	Soporte cristal elevalunas trasero izquierdo VW Golf V y VI '04->'13, Passat '05->'10, Polo '09->'14	163.999	
1	Soporte cristal elevalunas trasero derecho Audi A3 '04->'13	164.500	
1	Soporte cristal elevalunas trasero izquierdo Audi A3 '04->'13	164.501	
1	Soporte cristal elevalunas trasero derecho VW Touran '03->	164.502	
1	Soporte cristal elevalunas trasero izquierdo VW Touran '03->	164.503	



162.841



163.176



163.992* - Dcho.
163.993* - Izdo.



163.990* - Dcho.
163.991* - Izdo.



163.546* - Dcho.
163.547* - Izdo.



164.452* - Dcho.
164.453* - Izdo.



164.456* - Dcho.
164.457* - Izdo.

* (imagen 1/2 tamaño real)

U.E.	DESCRIPCION	261	Ref. Adaptable
10	Fijac. elevalunas y varilla apertura puerta VW Golf III, Polo '95	162.841	1H0 837 498
25	Fij. cristal lateral puerta trasera Seat Altea, Ibiza/Cordoba '02->'09, Leon '99->'05, Toledo '99->'09, Skoda Fabia '00->'09, Octavia '04->'08, Roomster, Superb, VW Bora, Golf IV y V, Passat '97->, Polo '95->'02 y '02->'09, Tiguan, Touran (ver PSA)	163.176	6N0 839 511
1	Soporte cristal elevalunas trasero derecho Seat Leon '99->'05, Toledo '99->'04	163.546	
1	Soporte cristal elevalunas trasero izquierdo Seat Leon '99->'05, Toledo '99->'04	163.547	
1	Soporte cristal elevalunas trasero derecho Audi A4 '01->'08, Seat Exeo	163.990	
1	Soporte cristal elevalunas trasero izquierdo Audi A4 '01->'08, Seat Exeo	163.991	
1	Soporte cristal elevalunas trasero derecho Audi A6 '04->'09	163.992	
1	Soporte cristal elevalunas trasero izquierdo Audi A6 '04->'09	163.993	
1	Soporte cristal elevalunas trasero derecho Audi A4 '08->, Q3 '11->, Q5 '08->	164.452	
1	Soporte cristal elevalunas trasero izquierdo Audi A4 '08->, Q3 '11->, Q5 '08->	164.453	
1	Soporte cristal elevalunas trasero derecho Skoda Octavia '05->	164.456	
1	Soporte cristal elevalunas trasero izquierdo Skoda Octavia '05->	164.457	



162.708



162.267



163.075



163.076



164.026



163.208



163.190



164.384



181.405*

* (imagen NO a tamaño real)

U.E.	DESCRIPCION	261	Ref. Adaptable
10	Fijac. tirante bandeja posterior VW Golf III (ver PSA)	162.708	
50	Fijac. anagramas de tipo de modelo, fijac. tapizados puerta Seat Ibiza/Cordoba, León, Toledo, Skoda Octavia, VW Golf, LT, Passat, Polo, Transporter	162.267	191 853 615 A
25	Fijac. anagramas Audi A4	163.075	8D0 853 622
25	Fijac. tapa interior retrovisor Seat Altea, Arosa, Toledo '05->, VW Golf IV, Lupo, Polo, Touran	163.076	865 853 231 A
25	Tapón desagüe (19,80) Audi A2, A3, A4, A5, A6, Q5, Seat Altea, Ibiza/Cordoba '99->'02, León '99->'05 y '05->, Toledo '99->'09, VW Caddy '04, Golf IV y V, Bora, New Beetle, Passat '97->'05, Scirocco '09, Tiguan, Touran	163.190	893 803 593
25	Tapón desagüe (29,60) Audi A2, A3, A4, A5, A6, A8, Q5, Q7, TT, Seat Ibiza / Cordoba '99, Leon / Toledo '99->'05, Skoda Superb '02, VW Golf IV, New Beetle, Polo Classic '00->'02	163.208	8D0 803 583 L
25	Fijac. marco ventanilla y retrovisor Seat Altea, Leon '13, Mii, Toledo '05, Skods Citigo, Rapid, VW Passat CC '09, Polo '02->, Up (ver BMW, Ford)	164.026	5Z0 853 695 191 853 231
-	Tope (plástico/goma) portón Seat Ibiza/Cordoba '97->'02, VW Passat '97->'00, Polo '95->'02	164.384	6N0 827 499
-	Tirante bandeja posterior VW Golf II, Jetta (long.total 265 mm.)	181.405	191 863 447 1H6863447B41



164.712



163.147



163.148



162.792



162.793



162.794



164.071



164.269



164.270



164.271



163.184*



163.185*



163.186*

* (imagen 1/2 tamaño real)

U.E.	DESCRIPCION	261	Ref. Adaptable
10	Fijac. moldura lateral Audi A3, A4, A6, A8	162.792	4A0 853 825 C
10	Fijac. moldura lateral Audi A3, A4, A6, A8	162.793	4A0 853 825
10	Fijac. moldura lateral Audi A3, A4, A6, A8	162.794	4A0 853 825 A
25	Fijac. moldura inferior puerta (talonera) Audi A3	163.147	8L0 853 909
25	Fijac. moldura inferior puerta (talonera) Audi A4	163.148	8D0 853 909 B
5	Soporte delantero estribera Seat Ibiza/Córdoba '95, Inca'98, VW Caddy '98, Polo '96, Polo '00	163.184	6K0 853 578
5	Soporte central estribera Seat Ibiza/Córdoba '95, Inca'98, VW Caddy '98, Polo '96, Polo '00	163.185	6K0 853 578 A
5	Soporte trasero estribera Seat Ibiza/Córdoba '95, Inca'98, VW Caddy '98, Polo '96, Polo '00	163.186	6K0 853 578 B
10	Fijac. moldura talonera puerta Audi A6 '11-> (forma parte del KIT: 4G0898909)	164.071	4G0 853 909 A
10	Fijac. moldura lateral (parte delantera) Audi A3 Coupé	164.269	8P3 853 825 A
10	Fijac. moldura lateral (parte trasera derecha) Audi A3 Coupé	164.270	8P3 853 826 B
10	Fijac. moldura lateral (parte trasera izquierda) Audi A3 Coupé	164.271	8P3 853 825 B
25	Fijac. moldura inferior puerta Audi A4 '08->, A5	164.712	8T0 853 909 A

2617



U.E.	DESCRIPCION	261	Ref. Adaptable
10	Fijac. moldura lateral VW Golf III (extremo anterior/posterior)	162.301	1H0 853 585
10	Fijac. moldura lateral VW Golf III (central)	162.302	1H0 853 585 B
10	Fijac. moldura lateral VW Golf III (extremo posterior)	162.303	1H0 853 585 A
50	Fijac. moldura VW Golf '90, Passat, Jetta, Vento (ver PSA)	162.501	357 853 575
50	Fijac. moldura y protector guardabarros VW Golf '88-'90	162.502	357 853 585 + 357 853 586
25	Boca fijac. moldura VW Golf, Passat (monta con 162.785)	162.786	357 853 586 D
10	Fijac. moldura lateral VW Passat '94->'97	162.788	3A0 853 575 A
10	Fijac. moldura lateral VW Passat '97->'04	162.789	3B0 853 575
10	Fijac. moldura lateral VW Passat '94->'97	162.790	3A0 853 575
10	Fijac. moldura lateral VW Passat '97->'04	162.791	3B0 853 576
50	Fij. moldura estribera VW New Beetle, fijac. rejilla delant. a parachoques Polo ->'00, Passat ->'97	162.837	3A0 853 586
10	Fijac. moldura lateral Audi A8 (ver Mercedes)	163.103	4D0 853 825 C
50	Boca fijac. molduras Audi A3, Q3, Q5, Seat Altea, Leon '99, Toledo '99 y '05->, VW Bora, Golf III, Passat '94->'05, Touareg (ver BMW, Fiat)	163.394	1H0 853 586
50	Boca fijac. moldura talonera puerta Seat Arona, VW Golf V, Passat '05, Scirocco '08, Tiguan	163.884	3C0 853 586
25	Fijac. talonera puerta Seat Alhambra '00, VW Sharan '00, fijac. revestimientos interiores Seat Altea, Arosa, Cordoba/Ibiza '02, Leon '99, Toledo '99, Skoda Fabia, Octavia '04, Superb, VW Caddy '04, Golf IV y V, Jetta, Lupo, Passat '97->'10, Polo '02, Tiguan, Touran, Touareg, Transporter '03 (monta junto con 163955)	163.956	3B0 867 334
25	Boca fijac. talonera puerta VW Amarok '10->, Caddy '04 y '11->, fijac. bisagra maletero A5 '08->, fijac. cubierta ventanilla puerta Golf VI '13->	164.649	3B0 867 334 B



U.E.	DESCRIPCION	261	Ref. Adaptable
25	Fijac. moldura piso puerta VW Golf II	162.500	191 853 577
25	Fijac. moldura VW Golf	162.677	171 853 585 171 853 585 A
25	Fijac. moldura VW Golf, Passat, Polo, Transporter (monta con 162.786)	162.785	357 853 585 A
25	Fijac. spoiler Seat Ibiza '93, Leon '99->'05, Toledo '99->'05, fijac. moldura a guardabarros VW Golf III, Passat	162.787	191 853 585 A
10	Fijac. moldura lateral VW Touareg	163.395	7L0 839 069
25	Fijac. talonera puerta VW Golf V, Phaeton	163.707	3D0 853 576
25	Fijac. moldura lateral puerta Seat Alhambra '10, Arona, VW Scirocco '09, Sharan '10, Tiguan, fijac. aletas VW Tiguan, fijac. talonera puerta y soporte cubierta portón trasero VW Passat '06	163.917	3C0 853 585
25	Fijac. moldura aleta delantera Audi Q2, Q3, Seat Ateca, fijac. moldura talonera puerta Audi Q3, Q5 '09->, Seat Ateca, Skoda Suberb '15->	163.929	8R0 853 909 A 8R0 853 909
25	Fijac. talonera puerta Audi A3 '97->'03, Seat Alhambra '00, VW Sharan '00, fijac. revestimientos interiores Altea, Ibiza / Cordoba '02, Leon '99, Toledo '99, Skoda Fabia '00, Octavia '04, VW Caddy '04, Golf IV y V, Jetta, Lupo, Passat '97->'10, Polo '02, Tiguan, Touran, Touareg, Transporter '03 (monta junto con 163956)	163.955	3B0 867 333
10	Fijac. moldura lateral Audi Q7	164.023	4L0 853 909
25	Fijac. moldura placa matricula VW Crafter '06-> (ver Mercedes, Smart)	164.027	2E1 827 649
25	Fijac. moldura puerta VW Touareg '11->	164.069	7P0 854 719
10	Fijac. moldura ventanilla puerta Audi Q5, VW Touareg '03->'10 (ver Mercedes)	164.081	7L0 853 585 A
25	Fijac. moldura puerta VW Touareg '03->'10	164.082	7L0 853 547 A
25	Fijac. moldura aleta trasera Audi Q3 '11->	164.562	8U0 853 909
25	Fijac. moldura lateral puerta Crafter '06-> (ver Mercedes)	164.618	2E1 867 289 C
25	Fijac. moldura emblema delantero Skoda Fabia '07->, Roomster '06->, Superb '08->, Yeti '10->	164.646	5J0 853 139



162.659



162.421



163.115



164.846



163.545



163.134



163.213



163.954



163.108



163.648



164.146



163.104



164.563



163.073



163.151

U.E.	DESCRIPCION	261	Ref. Adaptable
50	Fijac. panel puerta y revestimientos interiores VW Golf, Polo	162.421	801 867 299
50	Fijac. revestimientos interiores - varios modelos -	162.659	811 863 905 A
25	Fijac. tapizados interiores VW Caddy '04 y '11, Transporter T4 y T5, LT	163.073	4D0 867 299 D 701 867 549
50	Fijac. tapizados interiores VW Golf '98->'04, Bora, Lupo, Passat '97->'05	163.104	3B0 837 732
10	Fijac. tapizados bajo cristal trasero y alfombras Seat Alhambra, VW Passat, Sharan	163.108	3B9 863 689
25	Fijac. tapizados interiores VW Transporter (ver Renault)	163.115	251 867 299
25	Fijac. tapizados interiores pilar A, VW Polo '02->'09	163.134	6Q0 880 385
25	Fijac. tapizados puerta Seat Arosa, VW Lupo	163.151	6X0867301B01C
25	Fijac. moldura guía puerta corredera VW Caddy '04 y '11, Transporter '03->	163.213	7H0 843 658 A
25	Fijac. tapizados interiores pilar B y C Seat Altea, Ibiza/Cordoba '02->'08, Leon '05, Toledo '05 fij. moldura rejilla parabrisas "torpedo" Seat Altea, Leon '05, Toledo '05-> (Eurocode 7610LSCHRQ)	163.545	6L6 853 575 A 6L6 853 575
25	Fijac. tapizados interiores Seat Ibiza '09, VW Golf V y VI, Golf Plus, Passat '05->, Scirocco '09, Tiguan, Touran	163.648	3C0 867 333
25	Fijac. panel puerta Audi A6 '05->	163.954	4F0 831 719
25	Fijac. tapizados puerta Seat Alhambra '11->, VW Passat '05 y '11->, Sharan '11->, Tiguan	164.146	3C0 837 975
50	Fijac. tapizados interiores Audi A3 '03 y '08->, A4 '08->, A5, Seat Alhambra '10->, Altea, Mii, León '05 y '13, Toledo '05, Skoda Citigo, Octavia '04 y '09->, Superb, Yeti, VW Golf V, VI y VII, Jetta, Passat '13->, Polo '02 y '09->, Sharan '10->, Tiguan '16->, Touran, Up!	164.563	6Q0 853 147
50	Fijac. tapizados portón trasero Seat Toledo '13->, Skoda Fabia '07->'15, Roomster '06->'15, Rapid '13->, Superb '08->'15	164.846	5J0 819 055 A



162.847



163.105



163.072



163.152



163.154



163.877



162.230



163.082

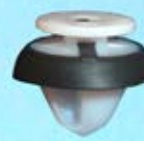

163.740



163.755



162.503



162.235



163.106



164.029

U.E.	DESCRIPCION	261	Ref. Adaptable
25	Fijac. revestimientos interiores Seat Alhambra, VW Sharan '96->'00 (ver Ford)	162.230	7M0 883 069
50	Fijac. panel puerta - varios modelos - (ver BMW, Ford)	162.235	823 867 299
50	Fijac. panel puerta VW Golf, Polo	162.503	171 807 249 A
50	Fijac. tapizados puerta, portón trasero y otros usos interiores Audi A3 '97->'03, A6 '98->'09, A8, TT, Seat Alhambra '96->'09, Seat Ibiza '97->'99, Córdoba '97->'02, VW Polo Classic '97->'02, Sharan '96->'09, Transporter '97->'03 y '03-> (Eurocode 3550SSCVFDX) (ver Ford)	162.847	7M0 867 299 K
25	Fijac. tapizados interiores Seat Arosa, VW Lupo, Polo '95	163.072	6X0 868 243 A
50	Fijac. tapizados posteriores Audi A4 '01->'08 (ver Dacia, PSA, Renault, Volvo)	163.082	8E9 867 299
50	Fij. tapizados interiores Audi A6, 80/100/200, Seat Ahambra '96->'09, VW Sharan '96->'09, Transporter '91->'09	163.105	703 867 299
50	Fijac. tapizados interiores Audi A6, A8, 80, 100	163.106	893 867 290
50	Fijac. panel puerta Seat Arosa, VW Lupo	163.152	6X0 867 300 A
50	Fijac. panel puerta Audi A4 '01->'08	163.154	8E0 867 276
50	Fijac. panel puerta Seat Ateca '16->, Arona, Ibiza '18->, Mii, Leon '13->, Toledo '13->, Skoda Citigo, Fabia '07->, Karoq, Kodiaq, Octavia '04->, Rapid, Roomster, Superb '15->, Yeti '10->, VW Amarok, Caddy '16->, Crafter '17->, Touran '16->, Up!	163.740	5J0 867 276
25	Fijac. cubierta carril guia puerta corredera VW Transporter '09->, LT '09	163.755	7H0 843 514
25	Fijac. panel puerta VW Golf V, Golf Plus, Jetta '06	163.877	1K6 837 200 A
50	Fijac. panel puerta Skoda Felicia, Pick Up, VW Caddy '96->'01	164.029	6U0 867 276 A

164.266

164.247

164.246

162.300

162.784

163.244

163.245

162.670

162.671

162.769

U.E.	DESCRIPCION	261	Ref. Adaptable
25	Fijac. panel puerta y revestimientos interiores VW Golf III (tipo largo)	162.300	1H0 868 243
25	Fijac. panel y revestimientos interiores VW Golf III / IV (monta con 162.671)	162.670	1H0 868 246 A
25	Fijac. panel y revestimientos interiores VW Golf III / IV (monta con 162.670)	162.671	1H0 868 244 B
25	Fijac. panel puerta VW Golf III	162.769	1H0 868 246 B
25	Fijac. panel puerta y revestimientos interiores VW Golf III, Golf IV (tipo corto)	162.784	1H0 868 243 B
25	Fijac. panel puerta y revestimientos interiores Seat Ibiza '93->'99, Cordoba '93->'02, Inca '96->'03, VW Caddy '96->'03, Polo Classic/Variant '96->'02	163.244	6K0 868 243
25	Fijac. panel puerta y revestimientos interiores Seat Ibiza/Cordoba, '93->'99, Inca '96->'03, VW Caddy ->'03, Polo '96->'02	163.245	6K0 868 243 A
25	Fijac. panel puerta Caddy '04, Golf V, Passat '05, Polo '02, Scirocco, Touran '03	164.246	6Q0 868 241 A
50	Fijac. panel puerta Caddy '04 y '11, Golf V y VI, Passat '05->'07, Polo '02, Scirocco, Touran '03, Transporter '09->	164.247	6Q0 868 297
25	Fijac. panel puerta Seat Mii, Toledo '13->, Skoda Citigo, Fabia '15, Kodiaq, Octavia '13, Rapid '13, Superb '15->, VW Amarok, Arteon, Caddy '16->, Golf 7 '12->, Passat '11->, Polo '18->, Tiguan '16->, Touran '16, Transporter '16->, Up!	164.266	3AA 868 243 A



163.468



163.469



162.946



163.089



163.470



163.541



164.265



164.145



163.387



163.117



163.212

U.E.	DESCRIPCION	261	Ref. Adaptable
25	Fijac. tapizados panel puerta Seat Ibiza/Cordoba '02->'08, León '99->'05, Toledo '99->'05, VW Golf IV '98->'04, Passat '97->'05 (Eurocode 8556LSCSFD)	162.946	3B0 868 243
25	Fijac. panel puerta Seat Ibiza/Córdoba '99->'02, VW Touareg	163.089	6K0 868 243 C
50	Fijac. panel puerta Audi A2, A4 '03->'09, Seat León '99->'05, Toledo '99->'05, Ibiza/Cordoba '02->'08, VW Passat '97->'05, Golf IV	163.117	8Z0 868 243 3B0 868 243
25	Fijac. panel puerta Audi A3 '03-> (2 puertas), TT '07->, R8	163.212	8P0 868 243
25	Fijac. panel puerta Audi A3 '03-> (4 puertas)	163.387	8P0 868 243 A
25	Fijac. tapizados puerta Audi A3 '04->, A4 '01->'08, Seat Exeo (Eurocode 8572LSCSFD1B)	163.468	8E0 868 243
25	Fijac. tapizados interiores VW Fox, Gol, Parati, Saveiro	163.469	5X0 867 299
25	Fijac. panel puerta Audi A1, A4 '08->, A5, A6 '11, A7, A8 '10, Q3, Q5, Q7, TT, Seat Alhambra '10, León '13, Skoda Rapid '12, VW Arteon, Caddy '04, Golf VI '09, Passat '11, Polo '10, Scirocco '09, Sharan '11, Tiguan '16, Touran '16->, Touareg '03, Transporter '03, T-Roc (Eurocode 8579SSCVFD) (ver Volvo)	163.470	7L6 868 243
25	Fijac. panel puerta VW Caddy '04, EOS, Golf V '04->'09, Passat '05->, Phaeton, Polo '02 y '10->, Tiguan, Touran (Eurocode 8568LSCHFD)	163.541	6Q0 868 243 6Q0 868 241
25	Fijac. panel puerta Audi A3 '13->, A4 '16->, A5 '17->, A8 '18->	164.145	8V0 868 243
10	Fijac. panel puerta Audi Q3, A6 '11->, Seat Arona, Ateca, Ibiza '18->, León '13->, Skoda Karoq	164.265	4H0 867 260

162.767

163.542

162.877

162.777

163.230

162.778

162.929

163.188

162.761

163.183

U.E.	DESCRIPCION	261	Ref. Adaptable
25	Botón obturación agujeros puerta VW Golf III	162.761	1H0 837 111 A
10	Fijac. revestimiento portón Skoda Octavia '97->, VW Golf III, Polo '95->'02	162.767	1H0 867 981
10	Fijac. metaloplástica revestimientos interiores Seat Arosa, VW Lupo, Polo '95->'02	162.777	6N3 868 561
25	Botón fijac. revestimientos interiores Skoda Fabia '00, Octavia '97, VW Golf III	162.778	N9057400101C
5	Fijac. tapizados interiores puertas traseras Audi A4 '95->'01, A6 '98->'05	162.877	8D0 839 825 A
25	Botón fijac. tapizados maletero Seat Ibiza/Córdoba '93, fijac. otros usos Seat Toledo '91->'99	162.929	6K6 863 988
10	Tapón panel puerta Seat Ibiza/Córdoba, VW Polo '95	163.183	867 971 928
25	Fijac. panel puerta y revestimientos interiores Audi 100, 200, A2, A3 '97->'03 y '03->, A4 '95->'08, A6 '95->'09, A8	163.188	8L4 831 720
25	Fijac. tapizados Seat Alhambra '96->'09, Altea, Leon '05->, Toledo '05->, VW Sharan '96->'09, Touareg, Transporter '03-> (ver Ford)	163.230	7M0 868 563
25	Fijac. tapizados interiores VW Passat '97->'05	163.542	N 908 131 01

2617



162.779



162.884



163.177



163.207



163.116



163.204



163.205



162.772



162.773



163.974



164.538



164.539

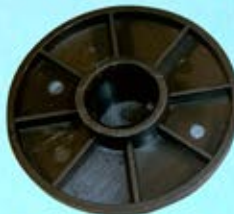

164.605



164.642

U.E.	DESCRIPCION	261	Ref. Adaptable
25	Fijac. revestimientos interiores laterales VW Golf III (sin espuma antivibrante)	162.772	1H0 867 276 A
25	Fijac. revestimientos interiores laterales VW Golf III (sin espuma antivibrante)	162.773	1H0 867 276 C
50	Fij. tapizados portón y otros usos interiores Seat Alhambra '96->'09, Arosa, Ibiza/Cordoba '93->'09, Inca, León '99->'05, Toledo '99->'05, Skoda Octavia '97->'09, Superb, VW Caddy '96->'03, EOS, Golf III, IV y VI, Jetta, Passat ->'05, Phaeton, Polo '95->'09, Scirocco '09, Sharan '96->'09, Touran, Transporter '03->	162.779	357 867 646
50	Fijac. tapizados techo Seat Toledo '92->'99, VW Golf II, Passat ->'93, Transporter '96->'04	162.884	321 867 838
50	Fijac. revestimientos interiores de montantes laterales Seat Ibiza/Cordoba '02->'09, Inca '99->'01, León '99->'05, Toledo '99->'05, Skoda Octavia '97->'09, Superb, VW Bora, Golf IV, New Beetle, Passat '97->'05, Polo '95->'02	163.116	6N0 867 276
25	Fijac. revestimientos interiores Seat Alhambra '03->'09, Ibiza/Cordoba '02->'09, León '05->, VW Sharan '03->'09, y fijac. revestimientos techo Córdoba '99->'02, Polo Classic '00->'02	163.177	6K0 867 838 A
25	Fijac. revestimientos laterales Seat Ibiza/Córdoba '02->'09, León '02->'05, Toledo '02->'05	163.204	1M0 867 276
25	Fijac. alfombras piso y revestimientos interiores VW New Beetle '06->, Golf IV	163.205	1J0 867 276 B
25	Fijac. tejadillo VW Golf IV '98->'02	163.207	1J0 867 646
25	Fijac. revestimientos interiores laterales traseros Seat Ibiza '09->	163.974	6J0 867 276
25	Fijac. tapizados interiores Audi A1, A3, A4, A5, A6, Q3, Q5, Q7, Seat Alhambra '10, Altea, Ibiza '08, León, Skoda Fabia '15, Superb, Yeti, VW Caddy '04, Golf V, VI y VII, Passat '05 y '10, Polo '10, Scirocco, Sharan '10, Tiguan, Touran, Touareg, Up!	164.538	3C08645239B9
25	Fijac. tapizados interiores Audi A1, A3, A4, A5, A6, Q3, Q5, Q7, Seat Alhambra '10, Altea, Ibiza '08, León, Skoda Fabia '15, Superb, Yeti, VW Caddy '04, Golf V, VI y VII, Passat '05 y '10, Polo '10, Scirocco, Sharan '10, Tiguan, Touran, Touareg, Up!	164.539	3C08645219B9
25	Fijac. tapizados interiores Audi A1, A2, A3, A4, A5, A6, Q3, Q5, Q7, Seat Alhambra '10, Altea, Exeo, Ibiza '08, León '05, Mii, Skoda Citigo, Fabia '15, Octavia, Superb, Yeti, VW Golf VI y VII, Passat '06, , Polo '10, Sharan '10, Tiguan, Touran, Touareg, Up!	164.605	8E08642299B9
25	Fijac. tapizados interiores Audi A1, A2, A3, A4, A5, A6, Q3, Q5, Q7, Seat Alhambra '10, Altea, Exeo, Ibiza '08, León '05, Mii, Skoda Citigo, Fabia '15, Octavia, Superb, Yeti, VW Golf VI y VII, Passat '06, , Polo '10, Sharan '10, Tiguan, Touran, Touareg, Up!	164.642	8E0864227



U.E.	DESCRIPCION	261	Ref. Adaptable
25	Fijac. tapizados interiores y parachoques Audi 80, 90, 100, A4, A6	162.704	811863905D01C
50	Fijac. revestimientos interiores VW Golf III (ver Mercedes)	162.780	191 867 199 C
50	Fijac. revestimientos interiores VW Golf III, Transporter '99->'04	162.781	1H0 867 199
50	Fijac. revestimientos interiores Audi A3 '04->, A4 '95->, A5, A6 '95->, Q5, TT, Seat Inca '96->'04, Skoda Fabia, Roomster, Superb, VW Caddy '96->'03, Golf III, LT, Polo '95->'02, Transporter (ver BMW, Ford, Opel)	162.782	N 90201601
50	Fijac. tapizados interiores (parte inferior trasera) Audi A4 '01->'05, A8, Seat Altea, Ibiza/Cordoba '93->'02, Inca, Leon '99->'05 y '05->, Toledo I, II y III, VW Caddy '96->'03, Golf II, Passat ->'97 (ver Ford)	163.129	357 863 119
25	Fijac. tapizados portón trasero Audi Q5, Seat Alhambra '09, VW Polo '09, Sharan '09, Touran '09, LT '09, Transporter '09	163.760	6X0 827 951 B
25	Fijac. insonorizante capó A3 '13, León '13, Golf VII '13, Passat '05 y '11, tapiz. maletero Octavia '04	164.017	N 909 113 01
25	Fijac. pasoruada Audi A1	164.143	8X0 868 298
25	Fijac. tapizados puerta Skoda Fabia, Octavia	164.169	6Y0 823 717
10	Fijac. pasoruada Audi A1 '12->, A4 '05->, A5, A6 '05->, A7, A8, Q3, Q5, Q7, TT '15->, Seat Exeo	164.648	8E0 821 989 A
50	Fijac. tapizados interiores A3 '13, Seat Ibiza '02, León '13, Toledo '13, Skoda Fabia '15, Octavia '13, Rapid, fijac. bisagra maletero Audi A1, A5	164.651	6Q0 867 333
50	Fijac. bajos carroceria A3 '97->'13, TT '15, Seat Alhambra '96->'10, Altea, León/Toledo '99->'12, Skoda Fabia '00, Octavia '97->'13, VW Golf 4, 5 y 6, Passat '05->'15, Polo '02, Sharan '96->'10, Scirocco, Touran '03->'15, Transporter T4 y T5, fijac. pasoruada Audi A2, A8	164.679	N90533301
50	Fijac. pasoruada Audi A4 '01->'08, Seat Exeo '08->, fijac. bajos carroceria A4 '95->'01, A6 '98->'11, Skoda Superb '02->'08, VW Passat '00->'05	164.823	82386320301C



163.893



164.144

Tornillo Ø 4



162.921

Tornillo Ø 4



162.924

Tornillo Ø 4,4



162.922

Tornillo Ø 4,4



162.923

Tornillo Ø 4,8



164.304

Tornillo Ø 5



164.546

tornillo Ø 6



162.948

Tornillo Ø 5



164.528

U.E.	DESCRIPCION	261	Ref. Adaptable
50	Fijac. pasoruedas, revestimientos y otros usos V.A.G. (ver BMW)	162.921	
50	Fijac. pasoruedas, tapizados y otros usos Seat Ibiza/Cordoba '93->'99, VW Golf IV, New Beetle, Polo '95->'02.	162.922	N 90474001
50	Fijac. pasoruedas, revestimientos y otros usos V.A.G. (todos los modelos)	162.923	171 201 969
50	Fijac. pasoruedas, parachoques y otros usos Seat Ibiza/Cordoba '93->'02, Inca, León '99->'05, Toledo '99->'05, VW Caddy '96->'03, Polo Classic '96->'02 (ver Mercedes)	162.924	441 955 973 B
50	Fijac. revestimientos (tornillo Ø 6) V.A.G. (ver B.M.W., Ford, Mini, Opel)	162.948	N 90127883
25	Fijac. pasoruedas Audi A1, A4 '08, A6 '05, A7, Q5	163.893	4F0 825 429 A
25	Fijac. pasorueda Audi A3 '13->, y fijac. tapizados maletero Passat '09->	164.144	4F0 825 429 B
50	Fijac. bajos carroceria Audi A1, A3 '03 y '13->, A4 '08->, A5, Q3, Q5, Seat Alhambra '11->, Altea, Exeo, Ibiza '02 y '08->, Cordoba, León '05 y '13->, Mii, Toledo '05 y '13->, Skoda Citigo, Fabia '07, Octavia '09->, Rapid, Superb, Yeti, VW Golf V, VI y VII, Passat '08->, Polo '05 y '09->, Scirocco, Sharan '11->, Tiguan, Touran, Up	164.304	WHT000713
25	Fijac. pasorueda y parachoques Audi A4 '08->, A5, A6 '11->, A7, Q3, Q5	164.528	8K0 821 213 A
50	Fijac. pasorueda y otros usos Audi A1, A3, A4, A6, A7, A8, Q3, Q7, Seat Alhambra, Altea, Arosa, Exeo, Ibiza/Cordoba, Inca, Leon, Mii, Toledo, Skoda Citigo, Fabia, Octavia, Rapid, Roomster, Yeti, Superb, VW Amarok, Caddy, Crafter, Golf IV, V, VI y VII, Passat, Polo, Scirocco, Sharan, Tiguan, Touran, Touareg, Transporter, Up!	164.546	N 90757901

6 x 6
Tornillo Ø 3



162.326

Ø 6
Tornillo Ø 4,2



162.783

6 x 6,5
Tornillo Ø 2,5



162.842

7 x 7
Tornillo Ø 3,5



162.817

7 x 7
Tornillo Ø 3,5



163.181

7 x 7
Tornillo Ø 3,5



162.776

7 x 7
Tornillo Ø 4



162.331

7 x 7
Tornillo Ø 4



162.775

7 x 7
Tornillo Ø 4,2



162.562

7 x 7
Tornillo Ø 4,2



162.244

7 x 7
Tornillo Ø 4,8



162.835

7 x 7
Tornillo Ø 5



164.438

7 x 14
Tornillo Ø 4,2



163.350

7 x 15
Tornillo Ø 4,2



162.888

U.E.	DESCRIPCION	261	Ref. Adaptable
100	Fijac. parachoques y otros usos Seat Ibiza/Cordoba '97->'02, Inca, Toledo '92->'99, VW Caddy '96, Golf Cabriolet, Polo Classic (ver Fiat, PSA)	162.244	155 809 966
100	Fijac. - varios usos - VW Golf '90 (ver Fiat, Seat)	162.326	
50	Fijac. pasoruada y otros usos Audi 100, 200, A2, A3, A4, A5, A6, A6, Q5, Q7, TT, Seat Alhambra, Altea, Arosa, Ibiza/Cordoba, Inca, León/Toledo, Skoda Fabia, Octavia, Roomster, Superb, VW Bora, Caddy, Golf (todos), EOS, Fox, LT, Lupo, Passat, Phaeton, Polo, Scirocco, Sharan, Tiguan, Touran, Touareg, Transporter	162.331	811 807 577 C 867 809 966
25	Fijac. - varios usos - Seat Ibiza, fijac. manecilla apertura puerta Audi 100, 200, A3 '97->'03, A4 '95->'01, A6 '95->'97, A8	162.562	443 853 547 B
25	Fijac. pasoruada Seat León '13, VW Fox '05, Gol, Polo Classic '04	162.775	6N0 809 966 A
25	Fijac. parachoques, rejilla radiador y revestimientos interiores Audi A4 '01, A8, Seat Alhambra, Altea, Arosa, Ibiza/Cordoba, León/Toledo, VW Bora, Caddy, Golf III, IV y V, Jetta, Lupo, New Beetle, Passat, Polo Classic, Sharan, Transporter	162.776	165 827 592
25	Fijac. rejilla toma aire a parachoques VW Polo '95	162.783	N 905 353 01
25	Fijac. faro Audi / VW (ver Nissan)	162.817	
25	Fijac spoiler lateral (bajo puerta) VW Golf III	162.835	1H0 853 947
100	Fijac. retrovisor exterior a puerta VW Golf III y IV, Polo '95, fijac. panel puerta Skoda Fabia,	162.842	1H0 853 120
50	Fijac. tapizados Seat Cordoba/Ibiza '99->'02, Toledo '92->'99, VW Polo ->'02 (ver Fiat)	162.888	1L0 867 616
50	Fijac. carcasa pasoruada interior Audi 100, A4, A6, VW Bora, Golf IV	163.181	811 807 577 B
50	Fijac. tapizados puerta VAG - varios modelos - (ver BMW)	163.350	N 910 444 01
50	Fijac. parachoques, pasoruada y bajos carroceria Seat Toledo '13->, Skoda Octavia '09, Rapid, Yeti, fijac. refuerzo parachoque delantero Skoda Fabia '11, Roomster '11	164.438	WHT003737

2617

6,8 x 7,5
Tornillo Ø 4,2



164.704

7 x 7,5
Tornillo Ø 3,5



162.774

7,5 x 7,5
Tornillo Ø 4,2



162.885

7,5 x 7,5
Tornillo Ø 4,2 - 4,8



162.836

7,5 x 7,5
Tornillo Ø 4,8



163.388

7,5 x 8,3
Tornillo Ø 4,8



164.168

8 x 8
Tornillo Ø 4,8



163.051

8 x 8
Tornillo Ø 4,8



162.833

8 x 8
Tornillo Ø 4,8



162.930

8 x 8
Tornillo Ø 4,8



162.716

8 x 8
Tornillo Ø 4,8



163.178

8 x 8
Tornillo Ø 5,5



163.211

9 x 10
Tornillo Ø 4,2



163.975

10 x 10
Tornillo Ø 4,8



163.393

10 x 14
Tornillo Ø 4,2



163.107

U.E.	DESCRIPCION	261	Ref. Adaptable
25	Fijac.matrícula - varios modelos -	162.716	321 813 988 A
50	Fijac. pasoruada y tapizados interiores Audi 100, 200, A2, A3, A4, A5, A6, A6, Q5, Q7, TT, Seat Alhambra, Altea, Arosa, Ibiza/Cordoba, Inca, León, Toledo, Skoda Fabia, Octavia, Roomster, Superb, VW Bora, Caddy, Golf (todos), EOS, Fox, LT, Lupo, Passat, Phaeton, Polo, Scirocco, Sharan, Tiguan, Touran, Touareg, Transporter	162.774	811 807 577 C
25	Fijac. matrícula VW Golf II, Passat, Vento	162.833	357 827 998
25	Fijac. pasoruada Audi A2, A4, Q3, Seat Ibiza/Cordoba '02, VW Lupo, Passat, Polo '02, Touareg, fijac. parachoques A3, A4, Q5, Q7, Seat Ibiza/Cordoba '99, León, Toledo, VW Golf IV, New Beetle, fijac. talonera Seat Altea, Toledo '05, fijac. tapizados VW Crafter '06	162.836	N 90821401
25	Fijac. pasoruada A3, A4, Q7, Altea, Arosa, Ibiza/Cordoba, León, Toledo, Caddy '04, Golf III, IV y V, EOS, Lupo, New Beetle, Passat '00, Phaeton, Polo, Scirocco '09, Tiguan, Touran, Transporter	162.885	N 908 338 01
25	Fijac. tapizados interiores y fijac. placa matrícula VW Golf, Passat, Polo, Transporter, Vento	162.930	357 868 143
25	Fijac. revestimientos interiores Audi 80, 100, A2, A4, A6, Seat Ibiza '02, VW Passat, fijac. talonera puerta VW Passat '97->'05, fijac. pasoruada Seat Altea, Toledo '05	163.051	4A0 857 610
25	Fijac. tapizados interiores Seat León '99->'05, Toledo '99->'05, VW Bora, Golf IV	163.107	1J0 853 120
50	Fijac. tapizados puerta A4, A5, Arosa, Caddy '04, Lupo, Golf IV y V, Scirocco '09, Passat '97->, fijac. moldura pasoruada Golf Plus, parachoques trasero A6, Altea, Ibiza/Cordoba '02, Polo '02->, fijac. panel puerta, moldura pasoruada y techo Q7, Touareg, Touran, Transporter	163.178	N 105 168 01
50	Fijac. parachoques VW Passat '88->'93, fijac. soporte placa matrícula VW Golf III - y varios usos -	163.211	175 867 949
50	Fijac. parachoques Audi A4 '01, Superb, VW Polo '00->, fijac. pasoruada VW Caddy '04, Phaeton	163.388	N 105 073 01
25	Fijac. pasoruada Audi A3 '13, Seat Alhambra '11, Ateca, Arona, Ibiza '18, León '13, Skoda Citigo, Kodiaq, VW Arteon, Polo '10->, Sharan '11->, Tiguan, fij. parachoque y tapizados interiores Audi A3, A4, A5, A6, Q7, TT, Skoda Fabia '15, Kodiaq, Octavia '18->, Rapid '12, VW Caddy '04, Golf V y VI, Passat '05, Scirocco '09, Tiguan, Touran '11-> (ver Ford)	163.393	N 10621301
25	Fijac. soporte matrícula Audi A6 '10->, A7 '10->	163.975	4G0 827 310
50	Fijac. tapizados interiores A1, Q7, Golf V, VI y VII, Passat '05->, Touareg '03, Touran '03 y '10->	164.168	N 909 946 01
50	Fijac. tapizados interiores Seat Toledo '13, Skoda Citigo, Fabia, Felicia, Octavia, Rapid, Roomster, Superb, Yeti, VW Up!, fijac. parrilla radiador VW Caddy '98	164.704	WHT003183

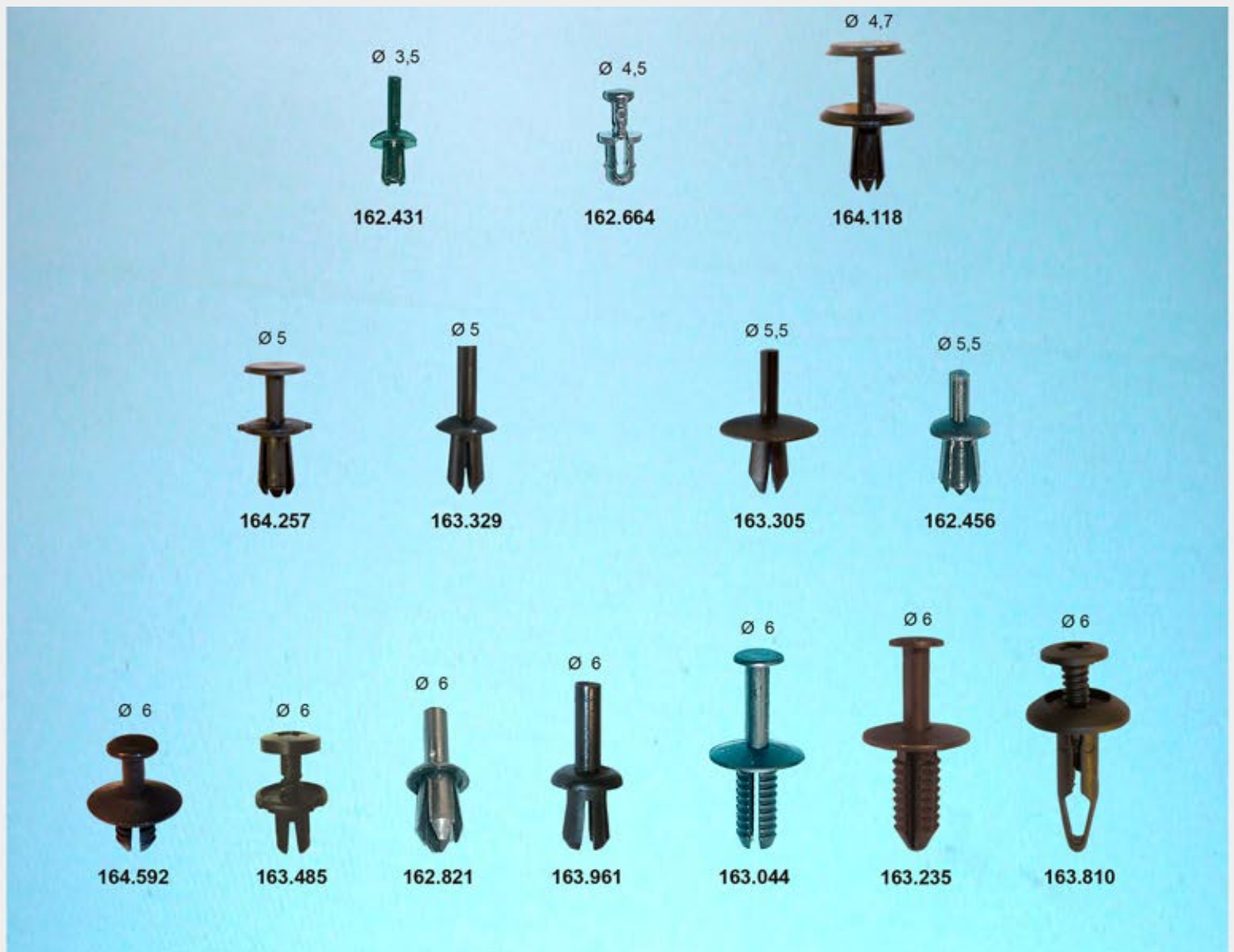

U.E.	DESCRIPCION	261	Ref. Adaptable
100	Remache fijac. varios usos V.A.G. (ver BMW, Mercedes, Opel, PSA)	162.431	113 857 117 B
50	Remache revestim. interiores -varios modelos- (ver BMW, Mercedes, PSA, Renault)	162.456	N10259301
25	Remache fijac. guarnición capó VW, Audi	162.664	893 823 740
100	Remache fijac. varios usos Audi A1, A3, A4 '08, A5, A8, Q7, Seat León '99->'05, Toledo '99->'05, Skoda Fabia, Octavia, Roomster, VW Bora, Golf IV, LT, New Beetle, Passat, Touran, Touareg, Transporter '03->	162.821	N0385011 N0385012
50	Remache fijac. parrilla radiador Seat Alhambra '96->'00, Toledo '13->, VW Sharan '96->'00, y fij. tapizados interiores Audi A3 '13, A8 '10, Q5 (ver BMW, Land Rover, Mercedes, Mini, Smart)	163.044	N 903 591 01
50	Remache fijac. varios usos V.A.G. (ver Mercedes, Opel)	163.235	
50	Remache fijac. parachoque VW LT '04->'07 (ver Mercedes, Opel, Volvo)	163.305	N 102 195 01 N 102 195 02
50	Remache fijac. tapizados interiores Seat León '99->'05, Toledo '92->'99 y '99->'05 (ver Nisan)	163.329	1L0 853 934
50	Remache fijac. tapizados interiores Audi A4, A6, Q5, Q7 (ver Mercedes, PSA, Smart)	163.485	7L6 868 307 8Z0 857 784
25	Remache fijac. parachoque trasero Audi A5, Q5 '09->, Seat Ibiza '09-> (ver Ford) fijac. aleta delantera Touareg	163.810	6L0 121 136
50	Remache fijac. talonera puerta Audi A1, fijac. pasoruera Skoda Octavia '04, fijac. parachoques Skoda Roomster '06, fijac. tapizados interiores Audi A2, Seat Arosa y otros usos -varios modelos-	163.961	N 104 179 01
50	Remache fijac. parachoque Audi A1, Skoda Roomster, fij. tapiz. interiores VW Polo '13->	164.118	N 107 009 01
50	Remache fijac. rejilla delantera, parachoque y tapiz. interiores Audi A4, A6, Seat Altea, Arosa, Exeo, Ibiza '02 y '09, Córdoba '03, León '05, Toledo '05, Skoda Fabia '00 y '07, Rapid, Superb, Yeti, VW Caddy '04, Golf V y VI, Lupo, Polo '02 y '09->, Tiguan, Touran	164.257	N 905 369 01
50	Remache fijac. soporte radiador Seat Altea, Córdoba '02, Ibiza '02 y '08->, León '05->, Toledo '05->	164.592	6L0 121 136 A

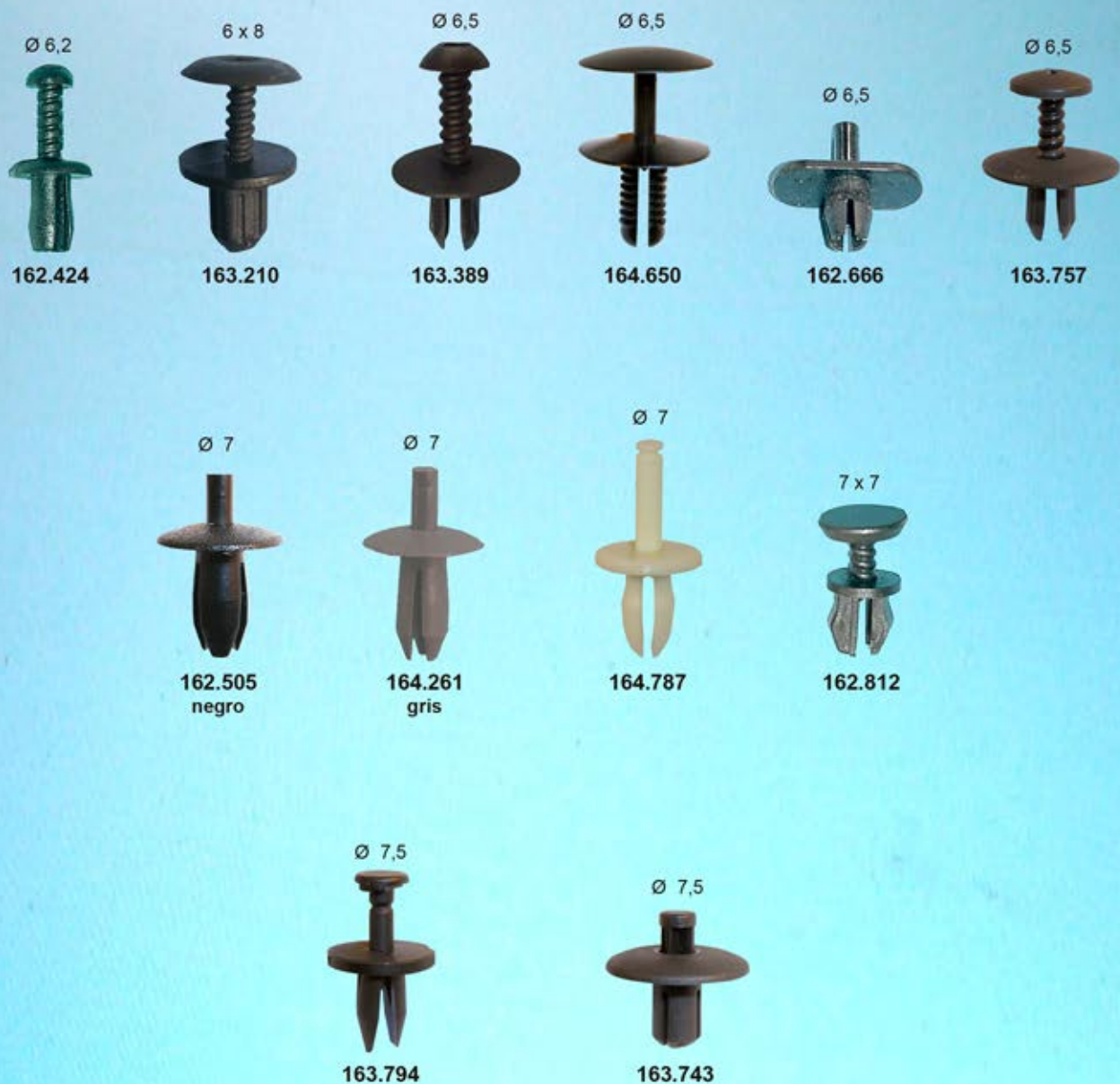

U.E.	DESCRIPCION	261	Ref. Adaptable
50	Remache fijac. tapa filtro rejilla Seat León / Toledo '99->'05 (ver Fiat, Mercedes, PSA, Renault)	162.424	1M0 853 547 A
50	Remache fijac. revestimientos interiores VW Golf y LT (ver Mercedes)	162.505	171 885 767
25	Remache fijac. guarnición puerta Audi 80, 90 y coupé, A4 '95	162.666	811 807 447
50	Remache fijac. tapizados interiores Audi A6 '05, Seat Altea, León '05, Toledo '05, VW Caddy '04, Golf V y VI, EOS, Jetta, New Beetle, Passat '05, Scirocco '09, Tiguan, Touran (ver Ford)	162.812	1C0 867 207
50	Remache fijac. revestim. interiores Seat Arosa, León '99, Toledo '99, Skoda Octavia '97, VW Golf, Lupo, New Beetle, Polo '00	163.210	1H0819145B41
25	Remache fijac. varios usos Audi A4, A6 (ver Volvo)	163.389	
25	Remache fijac. pasoruada Audi A2 '00->'05, A8, TT '07->, fijac. cubierta parachoque delantero Q5	163.743	4D0 807 300
25	Remache fijac. cubierta parachoques Audi A4 '08->, A5, Q5 '09->	163.757	8T0 807 300 A
50	Remache fijac. pasoruada, moldura estribera y rejilla parabrisas "torpedo" Seat Ibiza '09->	163.794	5P0 810 997
50	Remache fijac. revestimientos interiores varios modelos (ver Mercedes)	164.261	
25	Remache fijac. pasoruada A4 '08->, A5, Q5, fijac. otros usos A3 '13, A6 '05 y '11, Q3, Seat Exeo, Skoda Octavia '13->	164.650	4B0863907A01C
25	Remache fijac. panel elevalunas VW Golf VI '09->'13	164.787	5K0 837 975 A



U.E.	DESCRIPCION	261	Ref. Adaptable
100	Remache fijac. pasoruada, parachoque y bajos carroceria Audi A3, A4, A6, Q7, Seat Leon '13, Mii, Skoda Citigo, Octavia '13, Superb '16, VW Golf III, IV y VII, Passat '10, Polo, Scirocco, Sharan '10, Tiguan '10, Touareg, Touran, Transporter (ver Ford, Mercedes, Opel, PSA)	162.373	N 0385494 N 0385491 161 867 299
50	Fij.pasoruada y revestim. Audi TT, Seat Ibiza/Cordoba '99->'02, VW Bora, Golf, Passat, New Beetle, fij. parachoques Alhambra, Caddy '04, LT, Passat ->'97, Phaeton, Sharan, Touareg, Transporter, fijac. parrilla radiador Leon '99, Toledo '99, Polo, fij. armazón delantero Golf 3 (ver Ford)	162.632	N 0385501
25	Remache fijac. rejilla radiador y spoiler VW Caddy ->'92, Golf I y II, Transporter T2 ->'92	162.665	171 853 695 A
50	Remache fijac. rejilla parabrisas "torpedo" VW Golf III, Skoda Octavia '97->	162.765	1H0 819 055 C
50	Remache fijac. revestimientos interiores VW Golf III, Passat '92->'05	162.766	1H0 867 199 A
25	Remache fijac. revestimiento interior maletero Seat Cordoba '97->'09, Ibiza '97->'99, Bora, Golf III, New Beetle Cabrio, Passat ->'05, Polo '95, fijac. rejilla radiador Seat Leon '99->'05, Toledo '99->'05, fijac. gancho capó Audi A4 '95->'01	162.843	333 867 633 4FB
50	Remache fijac. varios usos VW Golf, Jetta'97 (ver Mercedes, PSA)	163.014	
25	Remache fijac. tapizados maletero Audi A3 '13->, TT, VW New Beetle '12-> (ver BMW, Mercedes, Mini, Mitsubishi, Volvo)	163.069	447 857 909
25	Remache fijac. insonoriz. A2 '00->'05, fijac. cubierta parachoques Q7, fijac. tapizados interiores A8 (ver Mercedes)	163.074	4D0 807 300 B
50	Fij. bajos carroceria A4 '01->, A5, A6 '05->, Q5, TT, Golf 5, Passat, Touran, fij. pasoruada A3 '04->, fij. conducto aire parach. Ibiza / Cordoba '02->, Leon '05, fij. suspensión Audi A3 '04->, Seat Altea, Leon/Toledo '05, Octavia '04, Superb, Golf V y VI, Passat '05, Tiguan, Touran (ver Chrysler, Ford, Land Rover, Opel, Renault)	163.091	8E0 825 267
50	Fijac. parachoques y bajo capó Audi 80, 100, 200, A6, bajos carroceria A8 '03-> (ver Ford, Renault)	163.306	N 902 293 01
50	Remache fijac. parachoque Seat Ibiza '08->, León '13-> (ver Mercedes)	163.409	6J0 853 379 2E1 857 784
25	Remache fijac. aleta delantera Audi A3 '08->, y fijac. tapizados Audi A4 '08, A6 '11, Q3 (ver BMW, Mercedes)	163.745	N105835019B9
50	Remache fijac. bajos carroceria Audi A5, fijac. tapizados interiores A5, A6, A7, Skoda Fabia '07-> (ver BMW)	164.097	N 911 415 01

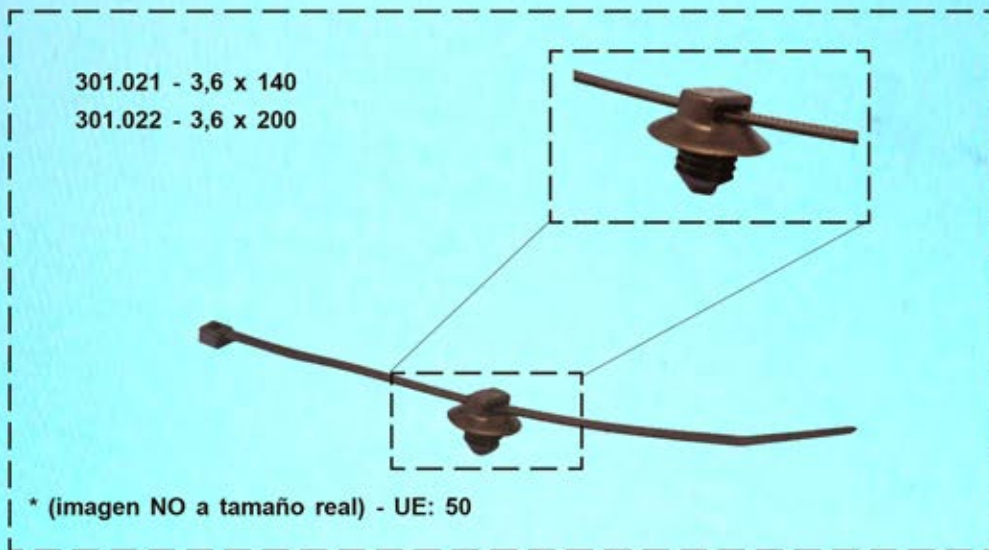

U.E.	DESCRIPCION	261	Ref. Adaptable
100	Remache fijac. revestimientos interiores VW Polo (ver PSA)	162.341	
10	Remache fijac. parachoques delantero Audi A3 '97->'03	163.109	8L0 807 300
50	Remache NEGRO fij. tapizados interiores Bora, Caddy '04, Golf III y IV, LT, EOS, Jetta, Passat '05, Phaeton, Polo '95, Tiguan, Touran, Transporter, Vento fijac. parachoques y radiador LT, Transporter	163.390	701 867 299 01C
50	Remache GRIS fijac. tapizados interiores Bora, Caddy '04, Golf III y IV, LT, EOS, Jetta, Passat '05, Phaeton, Polo '95, Tiguan, Touran, Transporter, Vento fijac. parachoques y radiador LT, Transporter	163.391	701 867 299 U71
25	Remache fijac. aletas Audi A1, A4 '08-> y fijac. puerta Audi A4 '08->	163.756	8K0 868 307
50	Remache fijac. aleta delantera Seat Ibiza '09-> (ver Volvo)	163.903	6J0 821 213
25	Remache fijac. bajos carrocería Audi A2 (ver Mercedes)	163.924	
50	Abrazadera 3,6 x 140 con soporte -varios modelos-	301.021	
50	Abrazadera 3,6 x 200 con soporte -varios modelos-	301.022	6K0 971 898 D



163.335



163.336



163.337



163.199



163.334



163.736



163.360



164.050

U.E.	DESCRIPCION	261	Ref. Adaptable
10	Fijac. moldura lateral parabrisas S60 '01->'09, V70 '00->'08, V70XC ->'07 (Eurocode 8829ASCES1B)	163.199	9190981
10	Fijac. moldura lateral parabrisas S60 '01->'09, V70 '00->'08, V70XC ->'07 (Eurocode 8829ASCSS / 8829ASCES)	163.334	30678009 9484524
10	Fijac. moldura superior parabrisas S40 / V40 '96->'04 (Eurocode 8824ASCST)	163.335	30800957
10	Fijac. moldura lateral parabrisas S40 / V40 '96->'04 (Eurocode 8824ASCSS / 8824ASC6B)	163.336	30800958
25	Fijac. moldura lateral parabrisas S40 / V40 '96->'04 (Eurocode 8824ASC6B / ASCES)	163.337	30873201
10	Fijac. moldura parabrisas 960 / 760 II (Eurocode 8812ASC6B)	163.360	1325285
10	Fijac. moldura lateral parabrisas Volvo 850 '93->'97, S70 / V70 '97->'00 y XC70 '98->'00	163.736	1372682
10	Fijac. moldura parabrisas Volvo 960 '91->'07, S90 '97->'98 (Eurocode 8812ASC6B)	164.050	1342004



163.761



163.762



163.763



163.958



163.764



163.838



163.839



164.657



164.656



164.658

U.E.	DESCRIPCION	261	Ref. Adaptable
10	Fijac. moldura lateral parabrisas (parte inferior) S80 '98->'06 (Eurocode 8828ASCS)	163.761	9190967
10	Fijac. moldura lateral parabrisas (parte media) S80 '98->'06 (Eurocode 8828ASCS7B)	163.762	9190970
10	Fijac. moldura lateral parabrisas (parte superior) S80 '98->'06 (Eurocode 8828ASCSS)	163.763	9190966
10	Fijac. moldura parabrisas (parte trasera) S80 '98->'06 (Eurocode 8828BSCSS)	163.764	6816180
10	Fijac. moldura lateral parabrisas (parte inferior) S60 '11->, V60 '14-> (Eurocode 8841ASCSSBS)	163.838	31304111
10	Fijac. moldura lateral parabrisas S60 '11->, V60 '14-> (Eurocode 8841ASCSS)	163.839	30753989
10	Fijac. moldura parabrisas -techo S60 '01->'09, S80 '98->'06, V70 '00->'08, V70XC (Eurocode 8829ASCES2B)	163.958	8622906
10	Fijac. moldura lateral parabrisas S60 '11, S90 '17, V40 '13, V60 '14 (Eurocode 8842ASCHS1B)	164.656	31333165
10	Fijac. moldura lateral parabrisas S60 '11, S90 '17, V40 '13, V60 '14 (Eurocode 8842ASCHS)	164.657	31333163
10	Fijac. moldura lateral parabrisas (parte superior) S90 '17->, XC60 '17-> (Eurocode 8846ASCRS)	164.658	31416877

163.647

163.644

164.021

163.643

163.646

164.311

164.172

164.283

U.E.	DESCRIPCION	261	Ref. Adaptable
10	Fijac. moldura inferior parabrisas S40/V40 '00->'04 (Eurocode 8824ASDS/ASSS) (ver Mitsubishi)	163.643	30874958
25	Fijac. rejilla parabrisas "torpedo" V40 '00->'04 (Eurocode 8832ASCSB6B)	163.644	30864984
10	Fijac. rejilla parabrisas "torpedo" S40/V40 '00->'04	163.646	30870550
25	Fijac. rejilla parabrisas "torpedo" S40/V40 '00->'04 (Eurocode 8824ASCSB)	163.647	30872551
25	Fijac. rejilla parabrisas "torpedo" S60 '01->'09, S80 '98->'06, S90, V70 '00->'08, V90 (Eurocode 8828ASCS6B)	164.021	685851
10	Fijac. moldura lateral parabrisas XC60 '09-> (Eurocode 8840ASCRS)	164.172	30753487
10	Fijac. moldura lateral parabrisas V70 '08->, XC70 '08-> (Eurocode 8836ASCSS)	164.283	30753556
25	Fijac. rejilla parabrisas "torpedo" S40 / V40 '96->'04 (Eurocode 8832ASCSB)	164.311	30870489

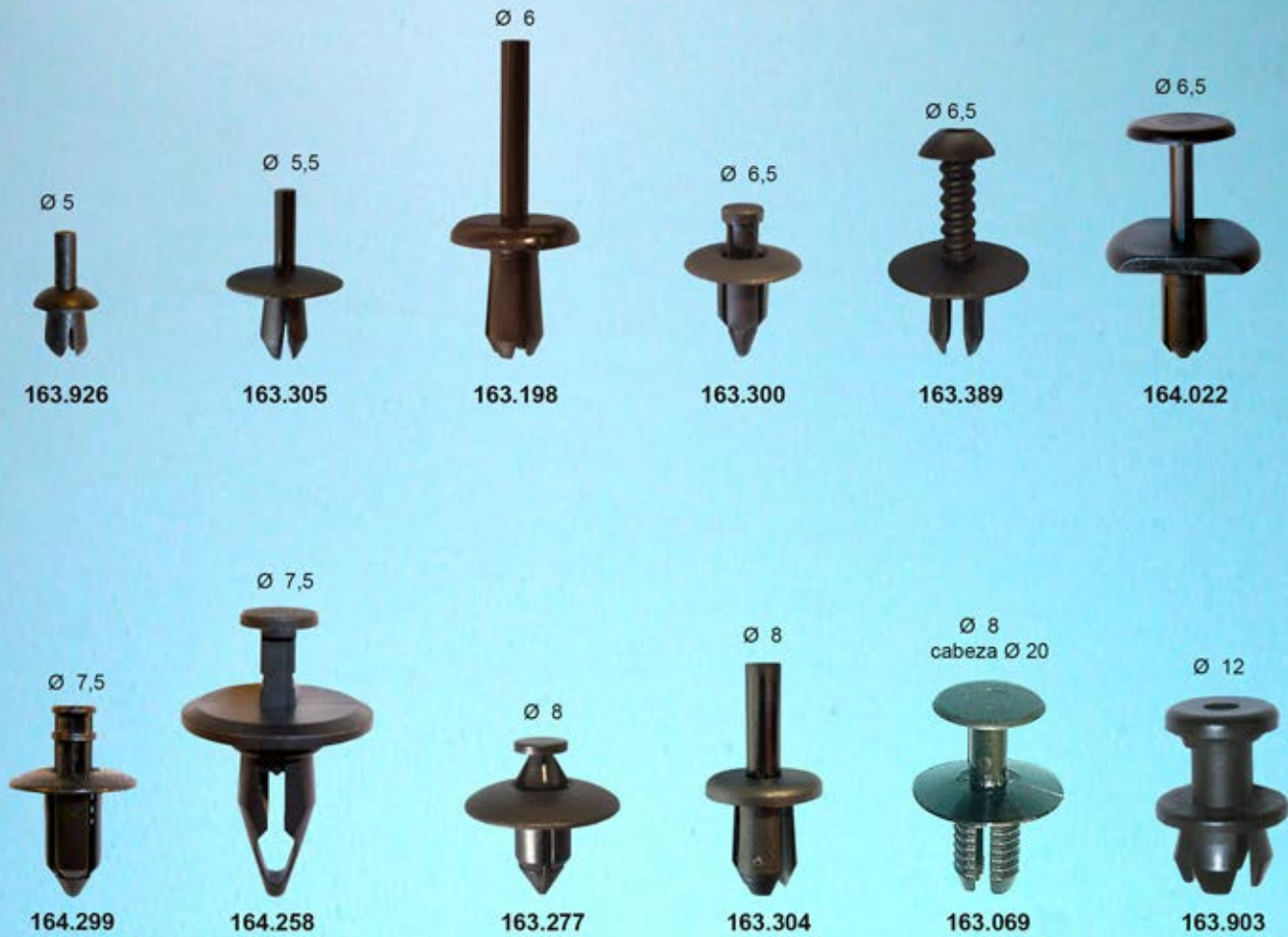

U.E.	DESCRIPCION	261	Ref. Adaptable
25	Fijac. cubrecárter y bajos carrocería S40/V40 '00->'04 y otros usos V70, XC70 (ver BMW, Mercedes, Mini, Mitsubishi, VAG)	163.069	30820141
25	Fijac. rejilla parabrisas "torpedo" S40 '04, S60 '01, V50, V70/XC70, XC90 (Eurocode 8828ASCSB) fij. spoiler S40 '04, V50, fij. deflector puerta XC60, parachoques 740, 760 (ver Mercedes, Opel)	163.198	1268176
25	Fijac. parachoques S40 '04->, S60 '01->, S80 '99->'06 y '07->, V50, XC60, XC70, C30, C70 '06, fijac. otros usos XC90, fijac. rejilla parabrisas "torpedo" XC60 '10-> (ver Honda, Nissan)	163.277	3541113
25	Fijac. rejilla parabrisas "torpedo" C30, C70, S40 '04->, V50 '04-> (Eurocode 8011ASCH) (ver Mitsubishi, PSA, Subaru, Suzuki, Toyota)	163.300	987789
25	Fijac. moldura talonera puerta S40 '04, S60 '01->'09, V50, V70 '00->'07, C30, fijac. tapizados puerta C70, fijac. parachoques C70, V70 '97->'04	163.304	9133417
50	Fijac. parachoques y moldura exterior S40 / V40 '00->'04 (ver Mercedes, Opel, VAG)	163.305	3923475
25	Fijac. moldura y panel puerta C70 '06->, fij. otros usos 850, S70/V70 '97->'00 (ver VAG)	163.389	3545549
50	Fijac. parachoques S40 / V40 '96->'04, fijac. talonera puerta S80 '07-> (ver VAG)	163.903	30817220
50	Fijac. varios usos -varios modelos- (ver Mercedes, Opel, Renault)	163.926	947098
10	Fijac. rejilla parabrisas "torpedo" S60 '11->, S80 '07->, V70 '08->, XC60, XC70, XC90 '03 (Eurocode 8836ASCSB)	164.022	8662958
10	Fijac. moldura talonera puerta C70 '06->	164.258	30741275
25	Fijac. rejilla parabrisas "torpedo" S90 '15->', XC90 '16->, fijac. parachoques S60 '11->, S80 '99->'06, XC60 y XC90	164.299	30622628 3533394



161.870



164.058



164.248



163.225



163.470



163.754



163.082



164.064



164.159



163.811



164.048



163.890



162.959



164.049



164.288



164.544



164.545

U.E.	DESCRIPCION	261	Ref. Adaptable
25	Remache fijac. moldura aleta S40 '04->'12, V50 '04->'12, S60 '01->'09, S80 '99->'06, V70 '98->'07, XC90 '03->'14	161.870	9798786 1372026
50	Fijac. junta puerta delantera XC90 '03-> (ver Ford)	162.959	30661329
50	Fijac. moldura puerta S40 '08->, V50, fijac. talonera puerta C30, S40 '08->, V50, V70 '08->, XC70 '08-> (ver Dacia, PSA, Renault, VAG)	163.082	30648141
50	Fijac. junta goma puerta C70 '06-> (Ver Renault)	163.225	1285015
25	Fijac. panel puerta C30, C70, S40 '04->, V50 (Eurocode 8579SSCVFD) (ver VAG)	163.470	8679426
25	Fijac. panel puerta y tapizados interiores C30, C70, S40 '04, S60, S80, V40 '13, V50, V60 '11, V70 '00, XC60, XC70, XC90 (ver Ford, Land Rover, Mini)	163.754	8616645
10	Fijac. talonera puerta C30, S40 '04->, V50, V70 '08->, XC60 '09->, XC70 '08->	163.811	8678010 31214496
50	Fijac. parachoques delantero XC60, XC70, fijac. tapizados interiores S40 '04->	163.890	1224786
10	Fijac. talonera puerta S80 '07->, XC90 '03->	164.048	8620997
25	Fijac. aletas V70 '01->'07, XC70 '08->, XC90 '03->, fijac. parachoque trasero V70 y XC60	164.049	8659732
10	Fijac. insonorizante motor S40, S60, S80, V50, V60, V70, XC60, XC70, XC90	164.058	9182822
10	Fijac. panel puerta S80 '03->'06, XC90 '03->	164.064	30755028
10	Fijac. parachoque S40 / V40 '96->'04	164.159	30808521
25	Fijac. juntas puerta 850, 960, S60 '01->'09, S70 '97->'00, S80 '99->'06, S90, V70 '97->'08	164.248	9133073
10	Fijac. moldura puerta S80 '07->, V70 '08->, XC70 '08->, XC90 '03->	164.288	30784514
25	Fijac. tapizados interiores S40 '04, S60 '01 y '11->, S80 ->'16, V50, V60, V70, XC60, XC70, XC90	164.544	30653441
25	Fijac. talonera puerta S60 '11->, V60 '14->	164.545	30624192